



207

Key catalogue for bit, double bit, pump,
pin and pipe, muzzle, safe, cast,
rim, welded and fancy bow keys.

Catalogo chiavi a mappa, doppia mappa, pompa, gorges,
grugno, per cassaforte, «Cadorine», per mobili in ferro,
per mobili in stile, tipo Patent, per cantina, saldate.

Spezialkatalog für Bart- und Doppelbartschlüssel,
Chubbschlüssel, Tresor- und Geldschrankschlüssel,
Möbel- und Spezialschlüssel.

Catalogue clés à panneton, à double panneton,
à pompes, à gorges, à chiffres, de coffres-forts,
de meubles, de cave, soudées.

Catalogo llaves a mapa, doble mapa, frontal, gorges, puño,
para cajas fuertes, «Cadorine», para muebles, en hierro, para
muebles en estilo antiguo, tipo Patent, de sótano, soldadas.

Catálogo de chaves de palhetão, duplo palhetão, bomba, de gorges,
“grugno”, para cofres, “Cadorine”, para móveis de ferro,
para móveis de estilo, tipo Patent, para caves, soldadas.



Index	Terminologia	Terminologie	Terminologie	Terminologia	Terminologia	X
Key identification	Identificazione chiave	Schlüsselidentifikation	Identification clé	Identificación de la llave	Identificação de uma chave	XI
Technical information	Informazioni tecniche	Technische Auskünfte	Informations techniques	Informaciones técnicas	Informações técnicas	XII
Packing	Confezione	Konfektion	Conditionnement	Embalaje	Embalagem	XIV
New keys for internal doors	Nuove chiavi da interno	Neue Schlüssel für Innentüren	Nouvelles clés d'intérieur	Nuevas llaves para puertas interiores	Novas chaves para portas internas	XVI
Silca library	Libreria Silca	Silca bücherei	Librairie Silca	Libreria Silca	Livraria Silca	XVIII

Double bit and pump keys	Chiavi doppia mappa e pompa	Doppelbart- und Pumpenschlüssel	Clés double panneton et à pompe	Llaves doble mapa y frontal	Chaves de duplo palhetão e bomba	1
Safe keys	Chiavi per casseforti	Safeschlüssel	Clés pour coffre-forts	Llaves para cajas fuertes	Chaves para cofres	63
Pin, muzzle and "Cadorine" Keys	Chiavi a gorges, grugno e "Cadorine"	Gorges-, Faust- und Cadorineschlüssel	Clés à gorges, à groin et "Cadorine"	Llaves a gorges, a puño y "Cadorine"	Chaves tipo gorges, "Grugno" e "Cadorine"	81
Patent keys	Chiavi patent	Patentschlüssel	Clés patent	Llaves patent	Chaves patent	127
Ornamental keys	Chiavi in stile per mobili	Mobelschlüssel im Stil	Clés traditionnelles pour meubles	Llaves en estilo antiguo para muebles	Chaves para móveis de estilo	169
Welded keys	Chiavi saldate	Geschweisste Schlüssel	Clés soudees	Llaves soldadas	Chaves soldadas	187
Double bit and pump keys index	Indice chiavi doppia mappa e pompa	Index für Doppelbart- und Pumpenschlüssel	Index clés double panneton et à pompe	Indice llaves doble mapa y frontal	Indice chaves de duplo palhetão e bomba	196
Safe keys index	Indice chiavi per casseforti	Index für Safeschlüssel	Index clés pour coffre-forts	Indice llaves para cajas fuertes	Indice chaves para cofres	199
Pin, muzzle and "Cadorine" keys index	Indice chiavi a gorges, grugno e "Cadorine"	Index für Gorges-, Faust- und Cadorineschlüssel	Index clés à gorges, à groin et "Cadorine"	Indice llaves a gorges, a puño y "Cadorine"	Indice chaves tipo gorges, "Grugno" e "Cadorine"	200
Patent keys index	Indice chiavi patent	Index für Patentschlüssel	Index clés patent	Indice llaves patent	Indice chaves patent	204
Ornamental keys index	Indice chiavi in stile per mobili	Index für Mobelschlüssel im Stil	Index clés traditionnelles pour meubles	Indice llaves en estilo antiguo para muebles	Indice chaves para móveis de estilo	207
Welded keys index	Indice chiavi saldate	Index für Geschweisste Schlüssel	Index clés soudees	Indice llaves soldadas	Indice chaves soldadas	208
Brand index	Indice per marca	Marken - Index	Index pour marques	Indice para marca	Indice para marca	209



The first modern style catalogue was designed and published by Silca. Silca had the idea to provide to the Locksmiths a tool which allows for the easy recognition and identification of key blanks. The keys were presented in full scale drawings showing both a plan of the key blank and the profile, allowing the Locksmiths to offer up the original key to the drawing for positive identification. This style of the catalogue from Silca has been adapted world wide as an industry standard.



Il precursore dei moderni cataloghi chiavi è stato pubblicato da Silca. Da Silca nacque l'idea di fornire uno strumento di consultazione che permise per la prima volta ai negozi di ferramenta di individuare rapidamente e con sicurezza il duplicato corretto. Nel catalogo le chiavi erano riprodotte in grandezza naturale, ordinate alfabeticamente secondo la marca: con la semplice sovrapposizione della chiave originale alla pagina del catalogo era possibile individuare il duplicato cercato. Questo semplice espediente, nato per facilitare chi si accingeva a fornire dei duplicati di chiavi, divenne un canone per il settore e lo è tuttora. Ancora oggi l'impaginazione adottata da Silca, così come tutte le sue successive evoluzioni, sono divenute uno standard per il settore in tutto il mondo.



Silca gab den ersten modernen Schlüsselkatalog heraus. Im Hause Silca entstand die Idee, den Schlüsseldiensten ein Arbeitsmittel an die Hand zu geben womit es möglich ist, eine Kopie in kürzester Zeit zu identifizieren. Im Katalog wurden die Schlüssel in der Originalgröße, alphabetisch und nach Marken sortiert, dargestellt: mit dem simplen Darüberlegen des Originalschlüssels auf die Katalogseite war es möglich, die gesuchte Kopie zu identifizieren. Dieser einfache Notbehelf, eingerichtet zur Erleichterung aller im Schlüsselersatzgeschäft, wurde zur Regel in der Branche und ist es bis zum heutigen Tag. Heute, viele Jahre nach Einführung dieses Arbeitsmittels durch Silca gehört dieses – wie auch viele weitere Entwicklungen – zum weltweiten Standard.



Le premier catalogue moderne pour clés fut mis en page par Silca. Silca eut l'idée de fournir un instrument de consultation qui pouvait permettre aux quincailleries d'individualiser rapidement et en toute sécurité la copie correcte des clés. Le catalogue représentait les clés en grandeur naturelle, disposées par ordre alphabétique et par marque: par une simple superposition de la clé originale à la page du catalogue il était possible d'individualiser la copie désirée. Ce simple expédient, né pour faciliter qui devait copier les clés, est devenu et reste encore aujourd'hui pour tous un outil de travail essentiel dans la profession. Aujourd'hui, à distance de plusieurs années, la mise en page que Silca a utilisée et toutes les évolutions qui ont suivi, sont devenues standard dans ce secteur, dans le monde entier.



El primer catálogo de llaves moderno fue editado por Silca. De Silca nació la idea de proporcionar un instrumento de consulta que permitiese a las tiendas de ferretería determinar rápidamente y con seguridad el duplicado correcto. En el catálogo, las llaves venían reproducidas a tamaño natural y dispuestas en orden alfabético de marca: con la sencilla superposición de la llave original en la página del catálogo era posible determinar el duplicado deseado. Este sencillo recurso, nacido para facilitar a quienes se disponían a suministrar duplicados de llaves, devenía un canon y sigue siéndolo. Hoy, después de muchos años, la edición realizada por Silca, así como todas sus actualizaciones sucesivas, ha devenido un estándar del sector en todo el mundo.



A Silca publicou o precursor dos modernos catálogos de chaves. Da Silca nasceu a ideia de fornecer um instrumento de consulta que, pela primeira vez, permitiu às lojas de ferramenta individualizar de forma rápida e segura o duplicado correcto. No catálogo, as chaves estavam reproduzidas em tamanho natural, por ordem alfabética segundo a marca: era possível individualizar o duplicado procurado sobrepondo simplesmente a chave original à página do catálogo. Este procedimento simples, nascido para facilitar quem fornece duplicados de chaves, tornou-se numa norma para o sector e continua a sê-lo hoje em dia. A paginação adoptada pela Silca, como também todas as sucessivas evoluções, tornou-se num padrão para o sector em todo o mundo.





Silca is the leading European manufacturer of high quality keys with the wide range of products and the reputation for innovative research. Our keys catalogues are the most complete in the world: 60.000 different items to meet the specific needs of any section of the market. Our range of key-cutting machines comprises of a complete series of electronic machines which are accepted as world leaders in their technological excellence. In addition to keys and key-cutting machines, Silca also produces a wide range of accessories and point of sales display fittings.



Silca è il leader europeo nel servizio chiavi per qualità, gamma di prodotti, innovazione. I nostri cataloghi chiavi sono i più completi al mondo: 60.000 articoli diversi capaci di rispondere alle esigenze specifiche di qualsiasi mercato. La gamma delle duplicatrici comprende una linea completa di macchine elettroniche, punto di riferimento tecnologico di tutto il settore. La produzione Silca comprende oltre alle chiavi e alle duplicatrici, una vasta gamma di accessori e componenti di arredo per il punto vendita.



Silca ist im Bereich Schlüsselservice hinsichtlich Qualität, Produktpalette und Innovationen führend auf dem europäischen Markt. Unsere Schlüsselkataloge sind der vollständigsten auf weltweiter Ebene: 60.000 verschiedene Artikel, die den spezifischen Anforderungen jedes Marktes gerecht werden. Die Palette von Schlüsselkopiermaschinen umfaßt eine komplette Reihe von elektronischen Schlüsselkopiermaschinen, die die modernste Technologie auf dem Sektor darstellen. Die Silca Produktion umfaßt, abgesehen von den Schlüsseln, auch mit reichhaltigem Zubehör ausgestattete Schlüsselmaschinen und Einrichtungskomponenten für den Verkaufspunkt.



Silca est le leader européen dans le service clés par la qualité, la gamme et l'aspect innovatif de ses produits. Nos catalogues clés sont les plus complets du monde: 60.000 articles différents à même de satisfaire toutes les exigences de tous les marchés. La gamme des machines à tailler comprend une ligne complète de machines électroniques, point de référence technologique de tout le secteur. La gamme des produits Silca comprend non seulement les clés et les machines à les tailler dotées d'une vaste gamme d'accessoires mais aussi des systèmes modulaires pour aménager les points de vente.



Por calidad, gama de productos e innovación, Silca es la empresa europea líder en el sector de las llaves. Nuestros catálogos de llaves son los más completos del mundo: 60.000 artículos diferentes, proyectados y realizados para satisfacer las exigencias específicas de cualquier mercado. La gama de las duplicadoras incluye una línea completa de duplicadoras electrónicas, eso es el norte tecnológico de todo el sector. La producción de Silca comprende, además de las llaves, las máquinas duplicadoras, que van acompañadas con una amplia gama de accesorios y componentes de decoración del punto de venta.



A Silca é o líder europeu no serviço de chaves em qualidade, gama de produtos, e inovação. Os nossos catálogos de chaves são os mais completos no mundo: 60.000 artigos diferentes capazes de satisfazer as exigências específicas de qualquer mercado. A gama das máquinas duplicadoras compreende uma linha completa de máquinas electrónicas, ponto de referência tecnológico de todo o sector. A produção Silca, além das chaves e das máquinas duplicadoras, também compreende uma ampla gama de acessórios e elementos de decoração para o ponto de venda.

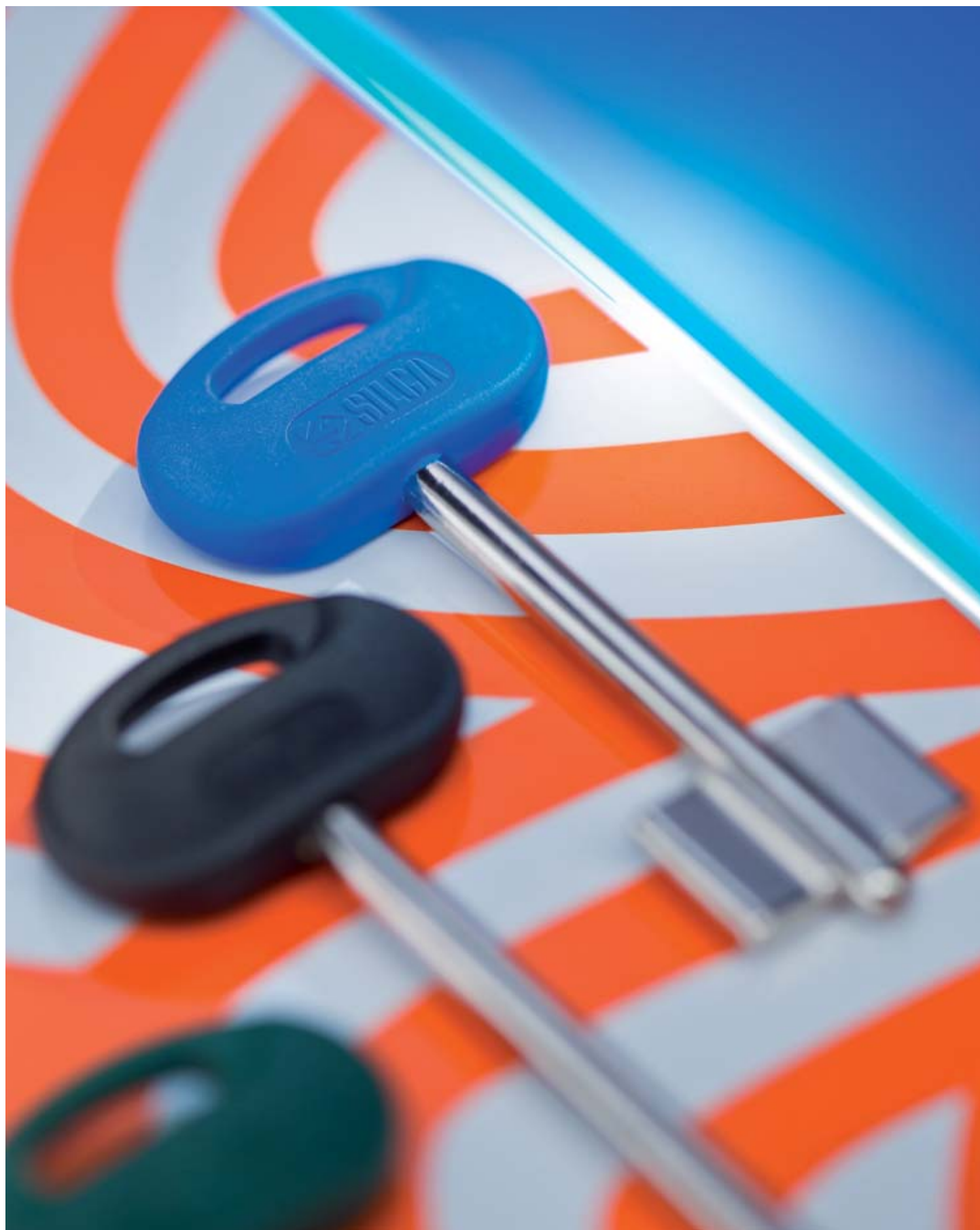



Continuous improvement is one of Silca's main objectives and the quality of service is undoubtedly the area in which such improvement is particularly desirable. For Silca the quality of service is not limited to quality in materials and finishes with a very wide range of products, but includes equal attention to all the articles in the catalogue, whatever their importance on the market. With this catalogue Silca offers you not just an update of all its key references, but also a new product philosophy that involves materials optimization to significantly improve the quality of service for slower-moving references. Your usual dealer or Silca Customer Service are at your complete disposal should you require more detailed information about the articles of interest to you.



Die ständige Verbesserung ist eine der wichtigsten Zielsetzungen von Silca und die Qualität der Leistungen ist ohne Zweifel der Bereich, wo diese Verbesserung mit Nachdruck verfolgt wird. Mit Qualität der Leistungen meint Silca nicht nur die Güte von Werkstoffen bzw. Nacharbeiten und eine ausserordentlich breite Auswahl an Produkten, sondern auch gleiche Aufmerksamkeit für alle Katalogartikel, egal ob die Nachfrage stark oder gering ist. Mit diesem Katalog möchte Silca nicht nur das Artikelverzeichnis auf den letzten Stand bringen, sondern auch eine neue Philosophie bieten, die durch die Optimierung der Werkstoffe eine wesentliche Verbesserung der Leistung hinsichtlich der weniger nachgefragten Produkte erzielen soll. Ihr Großhändler bzw. Silcas Customer Service stehen zu Ihrer Verfügung für jegliche Information über alle Artikel, die Ihr Interesse erwecken.



Lo de ir mejorando de continuo es uno de los objetivos más importantes de Silca y la calidad del servicio es, sin duda alguna, el sector que más desea mejorar. Para Silca calidad de servicio no significa sólo calidad de materiales y acabados y una gama producto extraordinariamente amplia, sino, sobre todo, la misma atención hacia todos los artículos en el catálogo cualquier que sea su difusión en el mercado. Con este catálogo, Silca le propone no sólo una actualización de todas sus propias referencias llaves, sino también una nueva filosofía de producto que, pasando a través de un proceso de optimización de los materiales, tiene el fin de mejorar tajantemente la calidad del servicio para las referencias menos difundidas. Su Distribuidor de confianza o el Customer Service Silca están a su total disposición para facilitarle informaciones exactas sobre los artículos en los que Ud. está interesado.



Il miglioramento continuo è uno dei principali obiettivi di Silca e la qualità del servizio è indubbiamente l' area in cui tale miglioramento è particolarmente voluto. Per Silca qualità di servizio non significa solo qualità di materiali e finiture e una gamma prodotto straordinariamente ampia, ma soprattutto pari attenzione a tutti gli articoli a catalogo qualsiasi sia la loro diffusione nel mercato. Con questo catalogo Silca Vi propone non solo un aggiornamento di tutte le proprie referenze chiavi, ma anche una nuova filosofia di prodotto che, passando attraverso l'ottimizzazione dei materiali, è destinata a migliorare significativamente la qualità del servizio per le referenze meno diffuse. Il Vostro Distributore Silca o il Customer Service Silca sono a completa disposizione per fornire informazioni precise sugli articoli di Vostro interesse.



L'amélioration continue est un de nos objectifs principaux et la qualité de notre service est incontestablement le secteur où cette amélioration se concrétise le plus. Pour Silca, qualité et service n'équivalent pas uniquement à la qualité des matériaux, des finitions et à un assortiment de produits extraordinairement vaste, mais surtout à un même soin pour tous les articles, quelle que soit leur diffusion sur le marché. Avec ce catalogue, Silca vous propose non seulement une mise à jour de tous ses articles clés, mais aussi une nouvelle philosophie du produit passant par l'optimisation des matériaux dans le but d'améliorer de façon significative la qualité de notre service pour les articles moins diffus. Votre Distributeur de confiance et notre Customer Service sont à votre entière disposition pour vous donner toutes les informations nécessaires sur les produits qui ont retenu votre attention.



O melhoramento contínuo é um dos objectivos principais da Silca e a qualidade do serviço é sem dúvida a área em que esse melhoramento é desejado de maneira particular. Para a Silca, qualidade do serviço não significa apenas qualidade de materiais e acabamentos e uma gama de produtos extraordinariamente ampla, como também uma atenção igual para todos os artigos presentes no catálogo, apesar da sua difusão no mercado. Com este catálogo, a Silca não propõe apenas uma actualização de todas as próprias referências chaves, como também uma nova filosofia de produto que, passando pela optimização dos materiais, é destinada a melhorar de maneira significativa a qualidade do serviço para as referências menos difundidas. O seu distribuidor de confiança ou o Customer Service Silca estão à sua inteira disposição para dar informações precisas sobre os artigos que lhe interessam.



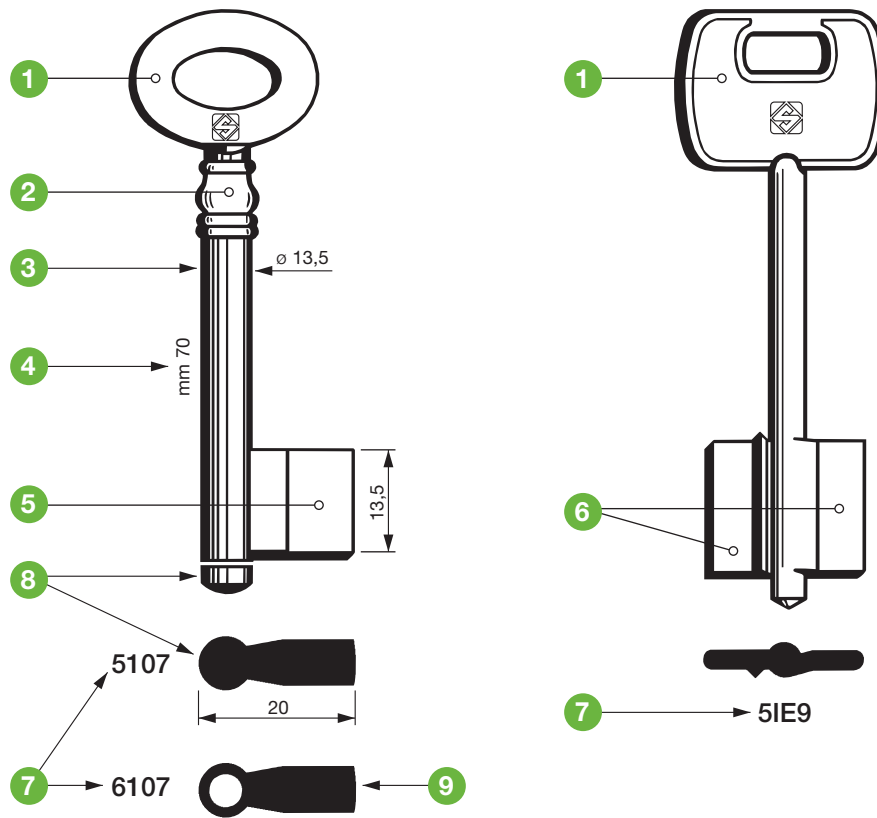

1	Head	Testa	Kopf	Tête	Cabeza	Cabeça
2	Collar	Colletto	Hals	Embase	Cuello	Colar
3	Stem diameter	Diametro del gambo	Schaftdurchmesser	Diamètre de tige	Diametro de la pala	Diâmetro da haste
4	Total length	Lunghezza totale	Gesamtlänge	Longueur totale	Longitud total	Comprimento total
5	Bit	Mappa	Bart	Panneton	Mapa	Palhetão
6	Double bit	Doppia mappa	Doppelbart	Double panneton	Doble mapa	Duplo palhetão
7	Silca item	Art. Silca	Silca-Artikel	Article Silca	Artículo Silca	Artigo Silca
8	Pin key	Maschio con mazzetta (piena)	Schlüssel mit durchgebender Stange und Bund	Mâle (à bout)	Macho con maza (llena)	Macho sem furo (cheia)
9	Pipe key	Femmina senza mazzetta (vuota)	Gebohrte Schlüssel mit Bund	Femelle (forée)	Hembra sin maza (vacía)	Fêmea com furo (vazia)

KEY IDENTIFICATION - IDENTIFICAZIONE CHIAVE - SCHLÜSSELIDENTIFIKATION - IDENTIFICATION CLÉ - IDENTIFICACIÓN DE LA LLAVE - IDENTIFICAÇÃO DE UMA CHAVE

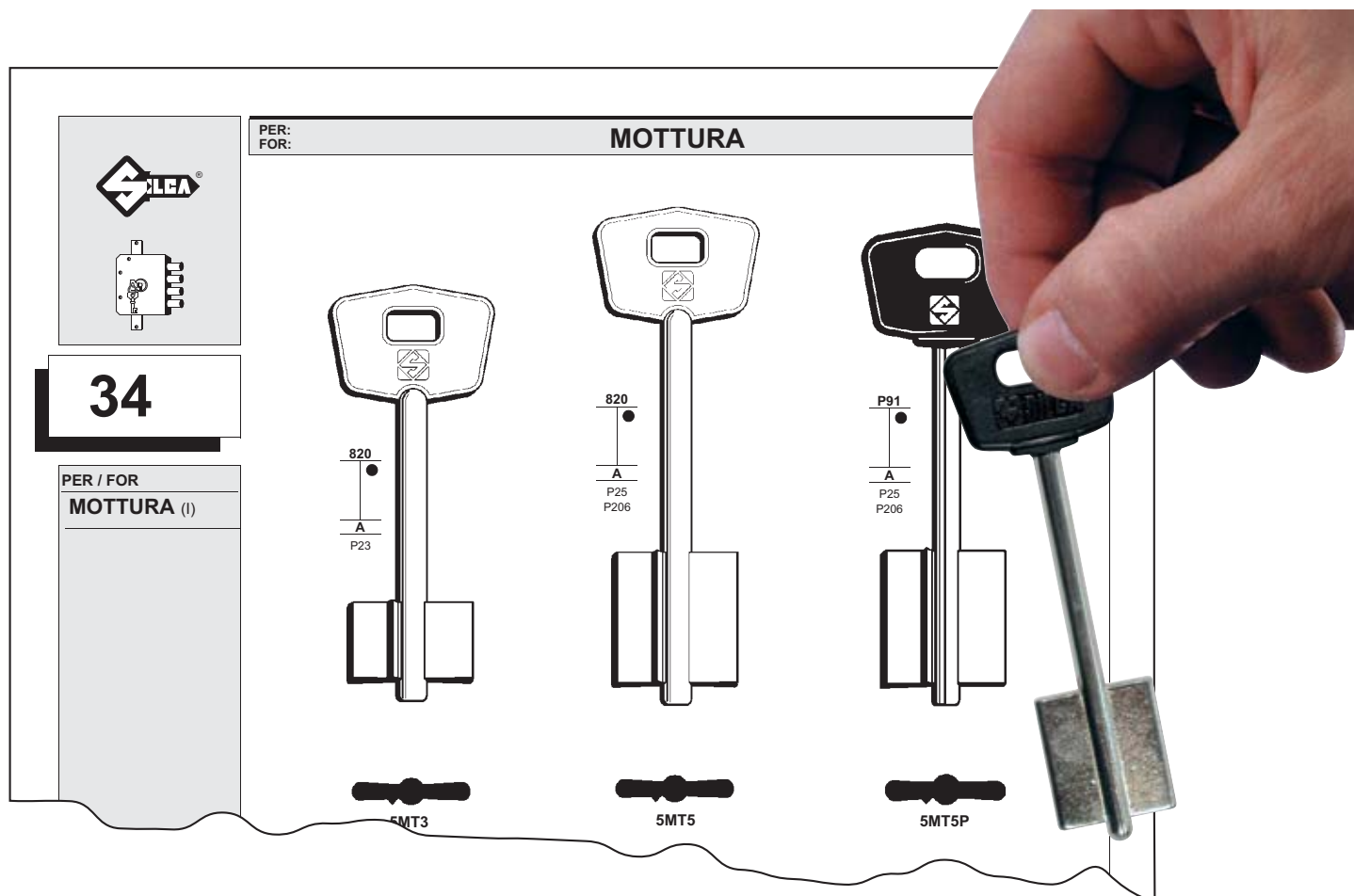

Keys are drawn to a 1:1 scale

Identification of a key may be made by laying the sample on the drawing, paying particular attention to the blade and to the profile.

Alternative head shapes are indicated by images around the standard head.



I disegni delle chiavi sono in scala 1:1

I profili (sezione della canna) sono visti dalla testa. Per la ricerca basta sovrapporre la chiave campione al disegno esaminando particolarmente la canna (gambo) e la sezione (profilo).

Teste originali diverse sono rappresentate con linea tratteggiata.



Die Zeichnungen der Schlüssel sind in Skala 1:1

Die Profile (Schnitt der Stange) werden vom Kopf ab gesehen. Für die Suche genügt es den Musterschlüssel mit der angegebenen Zeichnung zu vergleichen, aber wir empfehlen, besonders die Stange und das Profil zu überprüfen.

Verschiedene Originalköpfe sind durch gestrichelte Linien dargestellt.



Les dessins des clés sont à échelle 1:1

Les profils (section du canon) sont vus de la tête. Pour la recherche il suffira de superposer la clé échantillon au dessin en examinant tout particulièrement le canon (tige) et la section (profil).

Têtes originales différentes sont représentées par des lignes en tirets.



Los dibujos de las llaves son en escala 1:1

Los perfiles (sección de la caña) son vistos de la cabeza. Para la búsqueda basta sobreponer la llave de muestra al dibujo, examinando con particular atención la caña y la sección.

Las cabezas originales diferentes están representadas con una línea punteada.



Os desenhos das chaves estão em escala 1:1

Os perfis (secção da cana) são vistos da cabeça. Para uma pesquisa eficiente, basta sobrepor a chave original por cima do desenho e examinar atentamente a cana da chave e o perfil.

Cabeças originais diferentes estão representadas com uma linha tracejada.

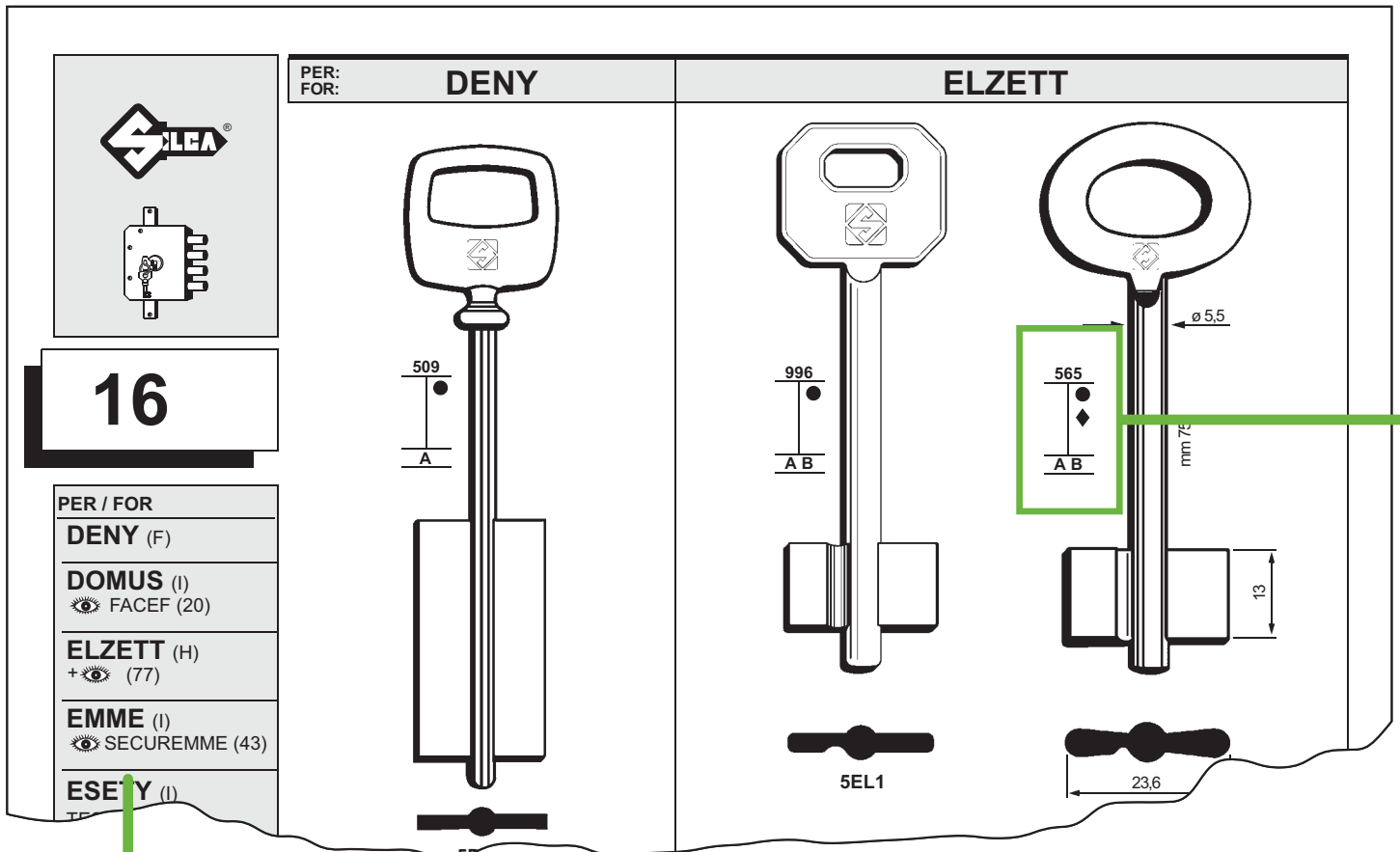

PER / FOR						
DENY (F)	Main brand (Nationality)	Marca principale (Nazionalità)	Hauptmarke (Nationalität)	Marque principale (Nationalité)	Marca principal (Nacionalidad)	Marca principal (Nacionalidade)
DOMUS (I) FACEF (20)	Refer to main brand on page indicated in brackets	Rinvio alla marca principale alla pagina indicata tra parentesi	Verweisung der Hauptmarke auf den angezeigten Seiten in Klammer	Renvoi à la marque principale à la page indiquée entre parenthèses	Reenvío a la marca principal en la paginas indicadas entre parentesis	Reenvia-se a marca principal em página indicada entre parênteses
ELZETT (H) (77)	Look back keyblanks under other brands on pages indicated in brackets	Rinvio alle chiavi di altre marche alle pagine indicate tra parentesi	Verweisung auf die Schlüssel anderer Marken auf den angezeigten Seiten in Klammer	Renvoi aux clés d'autres marques aux pages indiquées entre parenthèses	Reenvío a las llaves de otras marcas en las paginas indicadas entre parentesis	Reenvia-se para chaves de outras marcas em páginas indicadas entre parênteses
EMME (I) SECUREMME (43)	Nationality (page XIV)	Nazionalità (pag. XIV)	Nationalität (Seite XIV)	Nationalité (page XIV)	Nacionalidad (pág. XIV)	Nacionalidade (pág. XIV)
ESEY (I) TESIO	Secondary brands	Marche secondarie	Nebenmarke	Marques secondaires	Marca secundarias	Marca secundárias

TECHNICAL INFORMATION - INFORMAZIONI TECNICHE - TECHNISCHE AUSKÜNFTE - INFORMATIONS TECHNIQUES - INFORMACIONES TÉCNICAS - INFORMAÇÕES TÉCNICAS



Information including material type is shown alongside each key:

A fianco di ogni chiave sono specificate alcune caratteristiche tecniche e varianti disponibili:

Neben jedem Schlüssel sind einige technische Daten und mögliche Varianten angegeben:

A côté de chaque clé sont indiqués les caractéristiques techniques et matériaux disponibles:

Al lado de cada llave se especifican datos técnicos y variantes disponibles:

Ao lado de cada chave esta indicado as características técnicas e a matéria prima em que a chave pode ser fornecida:

123	Head shape code close to each key for easy identification of customized coining dies	Codice testa per facilitare la scelta di conii personalizzati	Kopf-Code, um die Auswahl der Prägungen zu erleichtern	Code de la tête pour faciliter le choix des frappes personnalisées	Código de la cabeza para facilitar la elección de acuñaciones personalizadas	Código da cabeça para facilitar a escolha dos cunhos, no caso dos pedidos de chaves personalizadas
▲	Steel	Acciaio	Stahl	Acier	Acero	Aço
●	Brass	Ottone	Messing	Laiton	Latón	Latão
■	Nickel Silver	Alpacca	Neusilber	Maillechort	Alpaca	Alpaca
◆	Iron	Ferro	Eisen	Fer	Hierro	Ferro
⬠	Cast iron	Ghisa	Gusseisen	Fonte	Hierro fundido	Ferro fundido
★	Zamak	Zamak	Zamak	Zamak	Zamak	Zamak
A	Nickel plated	Nichelate	Vernickelt	Nickelées	Niqueladas	Niqueladas
B	Polished brass	Ottone lucido	Poliert	Laiton poli	Latón brillante	Latão polido
E	Natural polish (SNI)	Naturali protette (SNI)	Poliert (SNI)	Maillechort brillant (SNI)	Brillo natural (SNI)	Brilho natural (SNI)
G	Polished and varnished	Lucidate e verniciate	Poliert und lackiert	Polies et laquées	Pulidas y barnizadas	Polidas e pintadas
H	Brass plated	Ottonate	Vermessingt	Laitonnées	Color natural	Revestidas de latão
J	Silver leaf plated	Argentate	Versilbert	Argentées	Bagno de plata	Prateadas
K	Zink plated	Zincate	Verzinkt	Zinguées	Galvanizado	Zincadas
L	Old black	Nero antico	Alt schwarz	Vieux noir	Negro antiguo	Preto antigo
M	Hand filed	Limate	Anfrage	Limées	Limadas	Limadas
P	Old bronze	Bronzo antico	Bronze	Vieil or	Bronce antiguo	Bronze antigo
Q	Gold	Dorate	Gold	Or	Oro	Douradas
P10	Silca Serial Number for cutting by code on the Prima Laser and Idea Machines.	Silca Serial Number per riproduzione a codice su Prima Laser e Idea.	Silca Serial Number für die Kopierung nach Code auf Prima Laser und Idea Maschinen.	Silca Serial Number pour la reproduction à code avec machines Prima Laser et Idea.	Silca Serial Number para la reproducción en base a código con Prima Laser y Idea.	Silca Serial Number para a duplicação pelo código nas máquinas Prima Laser e Idea.
S56	Silca Serial Number for cutting by code on Silca electronic machines for dimple and laser keys.	Silca Serial Number per riproduzione a codice su duplicatrici elettroniche Silca per chiavi punzonate e laser.	Silca Serial Number für die Kopierung nach Code auf Silca Elektronische Schlüsselkopiermaschine für Bohrmulden Schlüssel und Bahnen-Schlüssel.	Silca Serial Number pour la reproduction à code sur machines électroniques Silca pour clés a points et clés avec taille de type laser.	Silca Serial Number para la reproducción en base a código con duplicadoras electrónicas Silca para llaves de punto y llaves de regatas.	Silca Serial Number para a duplicação pelo código nas máquinas electrónicas Silca (chaves de pontos e tipo laser).

TECHNICAL INFORMATION - INFORMAZIONI TECNICHE - TECHNISCHE AUSKÜNFTE - INFORMATIONS TECHNIQUES - INFORMACIONES TÉCNICAS - INFORMAÇÕES TÉCNICAS

NATIONALITY - NAZIONALITÀ - NATIONALITÄT - NATIONALITÉ - NACIONALIDAD - NACIONALIDADE

A	Austria	E	Spain	J	Japan	RO	Romania
AUS	Australia	EST	Estonia	KSA	Saudi Arabia	RUS	Russia
AZ	Azerbaijan	ET	Egypt	LT	Lithuania	S	Sweden
B	Belgium	F	France	LV	Latvia	SCG	Serbia and Montenegro
BG	Bulgaria	FIN	Finland	MD	Republic of Moldova	SLO	Slovenia
BR	Brazil	GB	Great Britain	N	Norway	SU	ex-URSS
BY	Belarus	GR	Greece	NL	The Netherlands	TN	Tunisia
CDN	Canada	H	Hungary	P	Portugal	TR	Turchia
CH	Switzerland	HK	Hong-Kong	PL	Poland	USA	United States of America
CO	Colombia	HR	Croatia	PRC/CN	China	UA	Ukraine
CZ	Czech. Repub.	I	Italy	RC/TW	Taiwan	WAN	Federal Republic of Nigeria
D	Germany	IL	Israel	RA	Argentina	YV	Venezuela
DK	Denmark	IND	India	RCH	Chile	ZA	Republic of South Africa
DZ	Algeria	IRL	Ireland	RNR	Zambia		

PACKING - CONFEZIONE - KONFEKTION - CONDITIONNEMENT - EMBALAJE - EMBALAGEM

Double bit and pump keys	Boxes of 25 pieces	Cadorine keys	Boxes of 25 pieces
Chiavi doppia mappa e pompa	Scatole da 25 pezzi	Chiavi cadorine	Scatole da 25 pezzi
Doppelbart - und Pumpenschlüssel	Schachteln von 25 Stücke	Cadorineschlüssel	Schachteln von 25 Stücke
Clés double panneton et à pompe	Boîtes de 25 pièces	Clés cadorine	Boîtes de 25 pièces
Llaves doble mapa y frontal	Cajas de 25 unidades	Llaves cadorine	Cajas de 25 unidades
Chaves de palhetão e bomba	Caixas de 25 unidades	Chaves "Cadorine"	Caixas de 25 unidades
Safe keys	Boxes of 25 pieces	Patent keys	Boxes of 25 pieces
Chiavi per cassaforti	Scatole da 25 pezzi	Chiavi patent	Scatole da 25 pezzi
Tresorschlüssel	Schachteln von 25 Stücke	Patentschlüssel	Schachteln von 25 Stücke
Clés pour coffre-forts	Boîtes de 25 pièces	Clés patent	Boîtes de 25 pièces
Llaves para cajas fuertes	Cajas de 25 unidades	Llaves patent	Cajas de 25 unidades
Chaves para cofres	Caixas de 25 unidades	Chaves tipo patent	Caixas de 25 unidades
Pin and muzzle keys	Boxes of 25 pieces	Ornamental keys	Boxes of 25 pieces
Chiavi a gorges, e a grugno	Scatole da 25 pezzi	Chiavi per mobili	Scatole da 25 pezzi
Gorges und Faustschlüssel	Schachteln von 25 Stücke	Möbelschlüssel	Schachteln von 25 Stücke
Clés à gorges et à groin	Boîtes de 25 pièces	Clés pour meubles	Boîtes de 25 pièces
Llaves a gorges y puño	Cajas de 25 unidades	Llaves para muebles	Cajas de 25 unidades
Chaves tipo gorges e "grugno"	Caixas de 25 unidades	Chaves para mobiliário	Caixas de 25 unidades



KEYS FOR INTERNAL DOORS - CHIAVI DA INTERNO - SCHLÜSSEL FÜR INNENTÜREN - CLÉS D'INTÉRIEUR - LLAVES PARA PUERTAS INTERIORES - CHAVES PARA PORTAS INTERNAS





KEYS FOR INTERNAL DOORS

Keys for internal doors - Chiavi da interno - Schlüssel für Innentüren - Clés d'intérieur - Llaves para puertas interiores - Novas chaves para portas internas



Finishes - Finiture - Ausführungen - Finitions - Acabados - Acabamentos:

-  Polished brass / Ottone verniciato / Messing lackiert / Laiton verni / Latón barnizado / Latão polido
-  Nickel-plated brass / Ottone nichelato / Messing vernickelt / Laiton nickelé / Latón niquelado / Latão niquelado
-  Bronze finish brass / Ottone bronzato / Messing brüniert / Laiton bronzé / Latón bronceado / Latão bronzeado



A new concept key, where the bit is designed to act as a right or left-hand passe-partout. The key eliminates the difficulties in using classical passe-partout keys and also presents:

Design and ergonomics: to offer your customers a key that features modern styling to make it elegant and exclusive, together with ergonomic shaping;

Quality: these brass keys are made with technology that assures the highest quality size tolerances and workmanship;

Finishes and customization: polished brass and nickel plating are the new finishes. Other special finishes are available on request, to match the handles currently on the market;

Order management: from now on you no longer need to purchase all the models linked to each family of locks. Just order the right or left-hand keys only.

... from now on you really can choose your patent keys!



Es handelt sich um ein neues Konzept von Schlüssel, dessen Bart als rechtes oder linkes Passe-Partout verwendet werden kann. Dieser Schlüssel beseitigt die Schwierigkeiten bei der Verwendung der klassischen Passe-Partouts und zeichnet sich aus durch:

Design und Ergonomie: um Ihren Kunden einen Schlüssel mit modernem elegantem und exklusivem Design mit ergonomischer Form vorzuschlagen;

Qualität: für diese Messingschlüssel wurde eine Technologie angewendet, die Maßtoleranzen und qualitativ hochwertige Bearbeitung gewährleistet;

Ausführungen und personalisierungen: Lackiertes und vernickeltes Messing sind die neuen Ausführungen. Weitere Ausführungen auf Anfrage, zur optimalen Anpassung an die auf dem Markt erhältlichen Griffe;

Verwaltung: ab heute müssen Sie nicht mehr alle an jeden einzelnen Schlosstyp gebunden Modelle erwerben, sondern einfach Schlüssel mit rechtem oder linkem Profil bestellen.

... ab heute können Sie wirklich Ihren Patent-Schlüssel wählen!



Se trata de un nuevo concepto de llave, cuyo paletón ha sido diseñado para poder trabajarlo como llave maestra derecha o izquierda. Esta llave evita las dificultades al utilizar las llaves maestras clásicas y además presenta:

Diseño y ergonomía: para proponer a sus clientes una llave con un diseño moderno, elegante y exclusivo, y con la forma ergonómica;

Calidad: para estas llaves de latón, se ha adoptado una tecnología que asegura tolerancias en cuanto al tamaño y un trabajo de calidad superior;

Acabados y personalizaciones: Latón barnizado y niquelado son los nuevos acabados. Posibilidad de otros acabados especiales, bajo pedido, para hacer un juego perfecto con las asas que existen en el mercado;

Gestión: A partir de hoy Ud. ya no tendrá que adquirir todos los modelos que están sujetos a cada familia individual de cerraduras, sino que será suficiente pedir sólo las llaves derechas o izquierdas.

... ¡a partir de hoy Ud. puede elegir realmente su llave patent!



È un nuovo concetto di chiave, la cui mappa è stata disegnata per poter lavorare come passe-partout destro o sinistro. Questa chiave evita la difficoltà di utilizzo dei passe-partout classici ed inoltre presenta:

Design ed ergonomia: per proporre ai Vostri clienti una chiave dal design moderno, elegante ed esclusivo, e dalla forma ergonomica;

Qualità: per queste chiavi in ottone è stata adottata una tecnologia che assicura tolleranze dimensionali e lavorazione di qualità superiore;

Finiture e personalizzazioni: ottone verniciato e nichelato sono le nuove finiture. Possibilità di altre finiture particolari, su richiesta, per i migliori abbinamenti alle maniglie esistenti nel mercato;

Gestione: da oggi non dovrete più acquistare tutti i modelli legati ad ogni singola famiglia di serrature, ma vi sarà sufficiente ordinare le sole chiavi destre o sinistre.

... da oggi potete davvero scegliere la Vostra chiave patent!



C'est un nouveau concept de clés dont le panneton a été étudié pour pouvoir servir de passe-partout droit ou gauche.

Cette clé résout les problèmes liés aux passe-partout classiques et vous offre:

Graphisme et ergonomie: proposez à vos clients une clé au graphisme moderne, élégant, exclusif, à la forme ergonomique;

Qualité: la technologie adoptée pour ces clés en laiton garantit des tolérances dimensionnelles et d'usinage de qualité supérieure;

Finitions et individualisations: Laiton verni et nickelé, voilà nos nouvelles finitions. Vous pouvez nous demander d'autres finitions spéciales pour mieux assortir les clés aux nouvelles poignées sur le marché;

Gestion: vous ne devrez plus désormais acheter tous les modèles liés à chaque famille de serrure, il vous suffira de commander les clés droites ou gauches.

... désormais, vous pourrez vraiment choisir votre clé patent!



É um novo conceito de chave, cujo palhetão foi desenhado para poder trabalhar como passepartout direito ou esquerdo. Esta chave evita as dificuldades de utilização dos passepartout clássicos e também apresenta:

Design e ergonomia: para propor aos seus clientes uma chave com design moderno, elegante e exclusivo, e com forma ergonómica;

Qualidade: para estas chaves de latão foi adoptada uma tecnologia que assegura tolerâncias dimensionais e fabrico de qualidade superior;

Acabamentos e personalizações: latão pintado e niquelado são os novos acabamentos. Há a possibilidade de outros acabamentos especiais, por encomenda, para realizar as melhores associações com os puxadores presentes no mercado;

Gestão: a partir de hoje já não será necessário adquirir todos os modelos ligados a cada família de fechaduras, mas será suficiente encomendar apenas as chaves direitas ou esquerdas.

... a partir de hoje poderá de facto escolher a sua chave patent!

207

SILCA LIBRARY - LIBRERIA SILCA - SILCA BÜCHEREI - LIBRAIRIE SILCA - LIBRERIA SILCA - LIVRARIA SILCA



This catalogue updates and completes the information relating to all the bit, double bit, pump, pin and pipe, muzzle, safe, cast, rim, welded and fancy bow keys produced by Silca.

SILCA NEWS AND UPDATES* — To keep your catalogues up to date visit www.silca.biz, where you can find monthly updates on any new keys produced by consulting and printing the "Silca News" bulletins.



Dieser Katalog aktualisiert und ergänzt die Informationen bezüglich aller von Silca hergestellten Bart- und Doppelbartschlüssel, Chubbbschlüssel, Tresor- und Geldschrankschlüssel, Möbel- und Spezialschlüssel.

NEUHEITEN UND AKTUALISIERUNGEN SILCA* — Mit der Webseite www.silca.biz können Sie Ihre Kataloge immer auf dem letzten Stand halten. Durch Konsultation und Ausdruck der "Silca News", können Sie jeden Monat überprüfen, welche neuen Schlüssel hergestellt wurden.



Este catálogo actualiza y completa las informaciones relativas a todas las llaves a mapa, doble mapa, frontal, gorges, puño, para cajas fuertes, «Cadorine», para muebles, en hierro, para muebles en estilo antiguo, tipo Patent, de sótano y soldadas producidas por Silca.

NOVEDADES Y ACTUALIZACIONES SILCA* — Para que sus catálogos resulten siempre actualizados, conéctese con el sitio www.silca.biz. Podrá verificar cada mes cuáles nuevas llaves se han producido consultando e imprimiendo los boletines "Silca News".



Il presente catalogo aggiorna e completa le informazioni relative a tutte le chiavi a mappa, doppia mappa, pompa, gorges, grugno, per cassaforte, «Cadorine», per mobili in ferro, per mobili in stile, tipo Patent, per cantina e saldate prodotte da Silca. NOVITÀ E AGGIORNAMENTI SILCA* — Per mantenere sempre aggiornati i vostri cataloghi, collegatevi al sito www.silca.biz. Potrete verificare ogni mese quali nuove chiavi sono state prodotte consultando e stampando i bollettini "Silca News".



Dans ce catalogue, vous trouverez toutes les informations actualisées et complètes sur toutes les clés à panneton, à double panneton, à pompes, à gorges, à chiffres, de coffres-forts, de meubles, de cave et soudées produites par Silca.

NOUVEAUTÉS ET MISES À JOUR SILCA* — Pour avoir des catalogues toujours à jour, il suffit de vous connecter à notre site www.silca.biz. Vous y trouverez les nouvelles clés produites dans les bulletins "Silca News" imprimables.



O presente catálogo actualiza e completa as informações relativas a todas as chaves de palhetão, duplo palhetão, bomba, de gorges, "grugno", para cofres, "Cadorine", para móveis de ferro, para móveis de estilo, tipo Patent, para caves e soldadas produzidas pela Silca.

NOVIDADES E ATUALIZAÇÕES SILCA* — Para manter sempre atualizados os Seus catálogos, consulte o site www.silca.biz, onde poderá verificar todos os meses quais novas chaves foram produzidas consultando e imprimido os boletins "Silca News".



207



Silca News Bulletins

P393

Catalogue code
Codice catalogo
Katalog code

Code du catalogue
Código del catálogo
Código do catálogo

To order a copy of this catalogue: code P393.

Per ordinare una copia di questo catalogo: codice P393.

Um eine Kopie von diesem Katalog zu bestellen: Code P393.

Pour commander une copie de ce catalogue: code P393.

Para ordenar una copia de este catálogo: código P393.

Para ordenar uma cópia deste catálogo: código P393.

www.silca.biz

To update the 207 catalogue download the "Silca News" Bulletins. Monthly updates.

Per aggiornare il catalogo 207 scaricate i bollettini "Silca News". Aggiornamento mensile.

Um den Katalog 207 zu aktualisieren, entladen Sie bitte den "Silca News". Monatliche Aktualisierungen.

Pour ajourner le catalogue 207 téléchargez les bulletins "Silca News". Mises à jour mensuelles.

Para actualizar el catálogo 207 descarguen los boletines "Silca News". Actualizaciones mensuales.

Para atualizar o 207 catalogue descarreguem os boletins "Silca News". Atualizações mensais.

ELECTRONIC KEY CATALOGUE - CATALOGO CHIAVI ELETTRONICO - ELEKTRONISCHER SCHLÜSSELKATALOG - CATALOGUE ELECTRONIQUE CLÉS - CATÁLOGO LLAVES ELECTRÓNICO - CATÁLOGO CHAVES ELECTRÓNICO



Silca Electronic Key Catalogue - Silca gives you access to an electronic catalogue that contains all the paper catalogues and that can be instantly updated, in real time, with all the latest keys.



Catalogo Chiavi Elettronico Silca - Silca mette a vostra disposizione un catalogo elettronico che contiene al proprio interno tutti i cataloghi cartacei e può essere immediatamente aggiornato con tutte le ultime novità chiavi in tempo reale.



Elektronischer Schlüsselkatalog von Silca - Silca stellt Ihnen einen elektronischen Katalog zur Verfügung, der alle gedruckten Kataloge enthält und ein Updating mit den neuesten Modellen in Echtzeit ermöglicht.



Catalogue Electronique Clés Silca - Silca met à votre disposition un catalogue électronique renfermant tous les catalogues sur papier et pouvant être mis à jour immédiatement avec toutes les dernières nouveautés comme clés, et ceci en temps réel.



Catálogo Llaves Electrónico Silca - Silca pone a su disposición un catálogo electrónico que incorpora todos los catálogos tradicionales de papel y puede actualizarse inmediatamente con todas las últimas novedades de llaves en tiempo real.



Catálogo Chaves Electrónico Silca - A Silca disponibiliza um catálogo electrónico que contém todos os catálogos disponíveis em formato de papel e que pode ser imediatamente actualizado com todas as últimas novidades de chaves em tempo real.



**Electronic Key Catalogue
V.6.0.0**

P366

Catalogue code
Codice catalogo
Katalog code

Code du catalogue
Código del catálogo
Código do catálogo

To order a copy of this catalogue: code P366.
Per ordinare una copia di questo catalogo: codice P366.
Um eine Kopie von diesem Katalog zu bestellen: Code P366.
Pour commander une copie de ce catalogue: code P366.
Para ordenar una copia de este catálogo: código P366.
Para ordenar uma cópia deste catálogo: código P366.



**Web Electronic Key Catalogue
V.1.0.0**

**New web based
application**



Double bit and pump keys
Chiavi doppia mappa e pompa
Doppelbart- und Pumpenschlüssel
Clés double panneton et à pompe
Llaves doble pala y frontal
Chaves de duplo palhetão e bomba

FOR:
PER:

ANTONIOLI

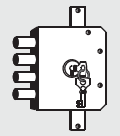

3

FOR/PER

ANTONIOLI (I)
AUNO

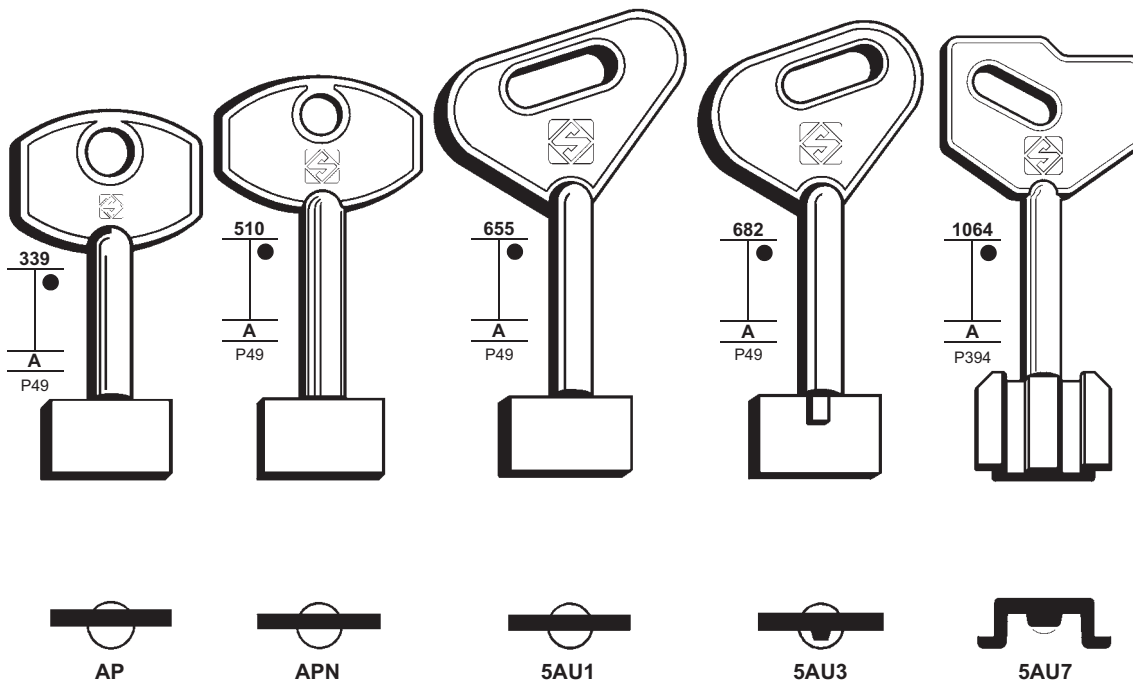

AUNO

AUNO

AUNO

FOR:
PER:

ANTONIOLI

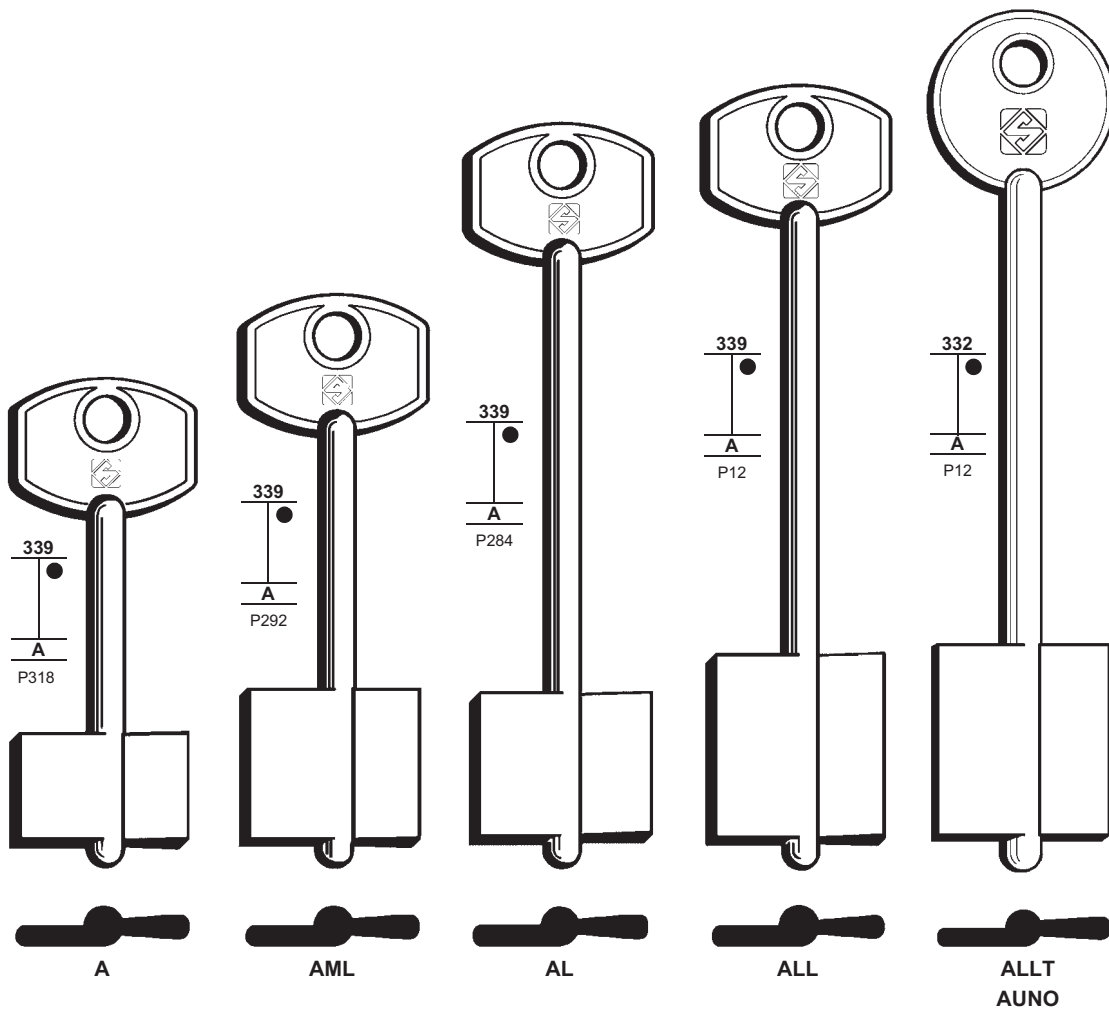

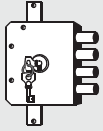

4

FOR/PER

ANTONIOLI (I)
AUNO

ASIAGHI (I)
JUWEL (37)

ASSA (S)
+ (70)

ATRA (I)

FOR:
PER:

ANTONIOLI

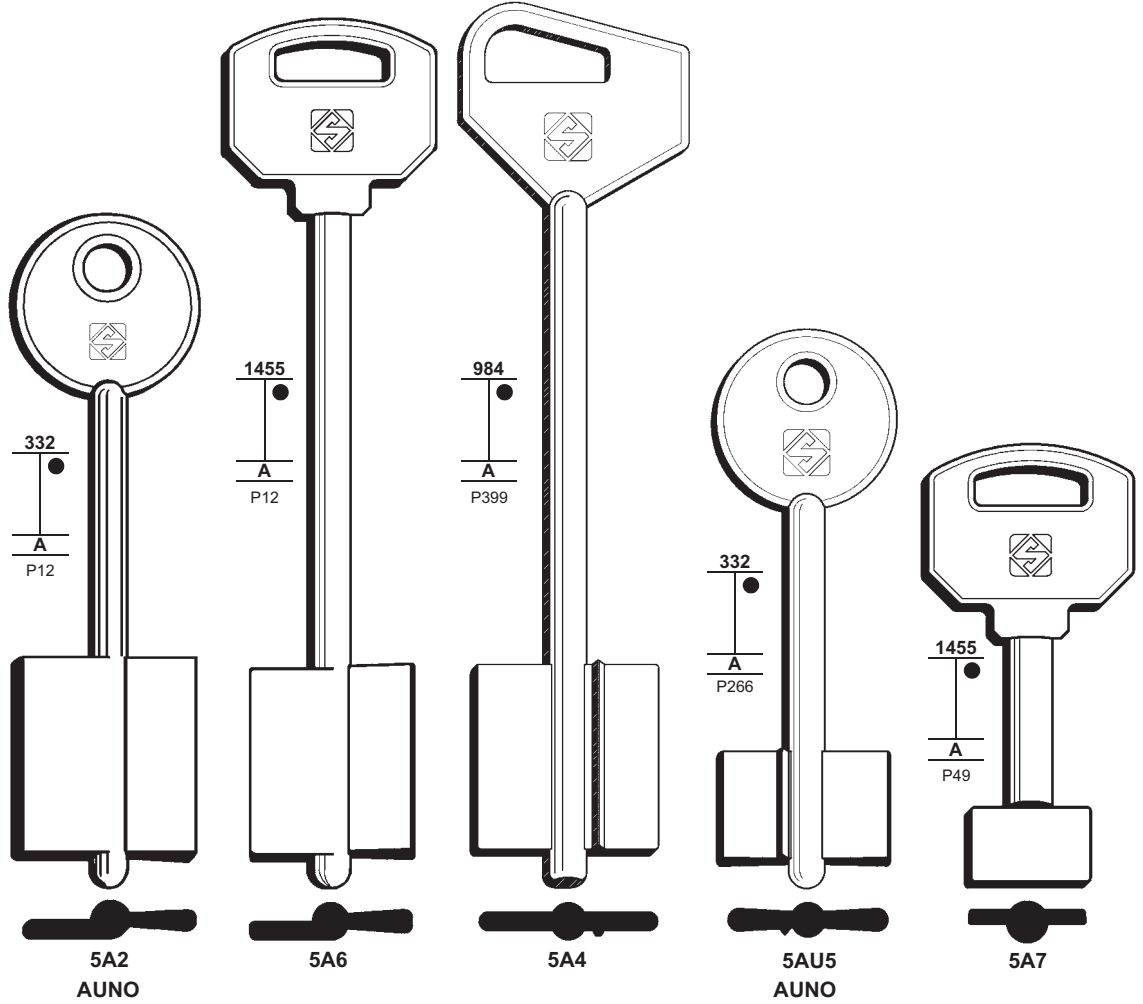

FOR:
PER:

ASSA

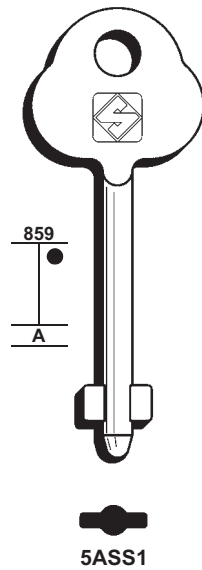

ATRA

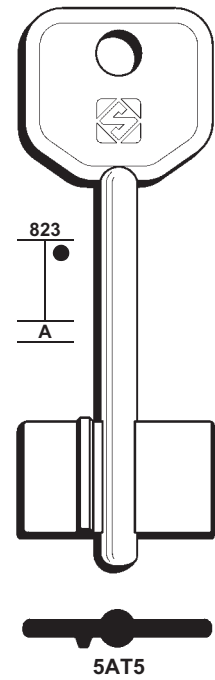
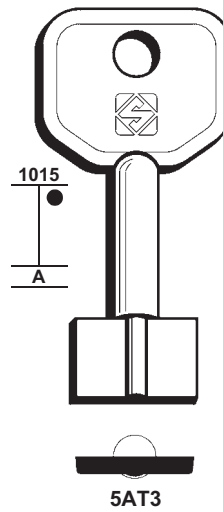

FOR:
PER:

ATRA



5AT13AP

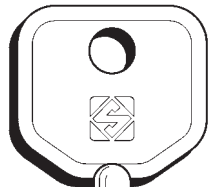

5AT9

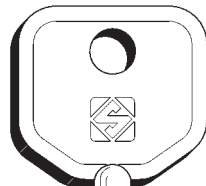

5AT7



5AT11AP

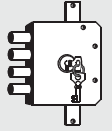

5

FOR/PER

ATRA (I)

AUNO (I)

+ ANTONIOLI (3-4)

FOR:
PER:

ATRA

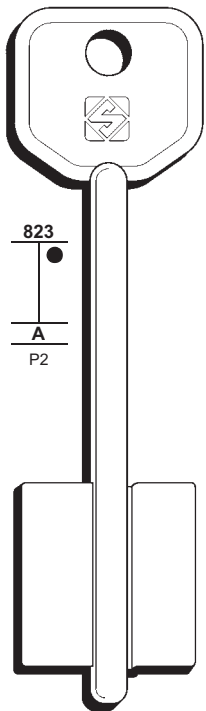

5AT1

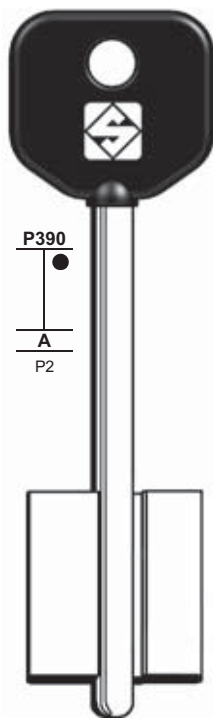

5AT1P

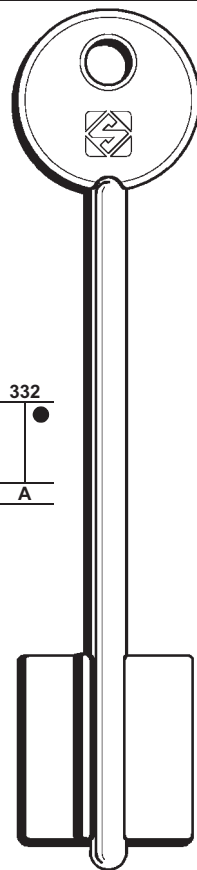

5AU9

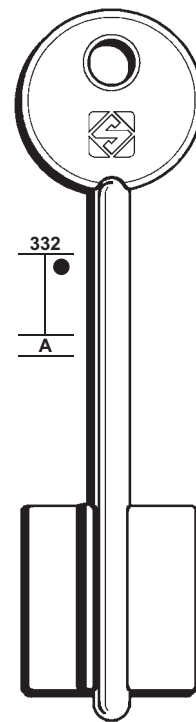

5AU11

AUNO

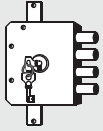

6

FOR/PER

AUNO (I)
+ ANTONIOLI (3-4)

AUTORI (I)
ISEO (35-36)

BETA (I)
POTENT

FOR:
PER:

AUNO

1064
A

5AU13

BETA

498
A

BE2

P179
A

BE2P

POTENT

FOR:
PER:

BETA

333
A

5BE3

333
A
P390

5BE5

333
A

BES

333
A

BE

333
A

BESC

333
A

BEC

FOR:
PER:

BETA

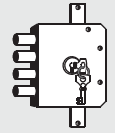

7

FOR/PER

BETA (I)

BLINKOR (I)

FACEF (27)

BMC (I)

BODA (FIN)

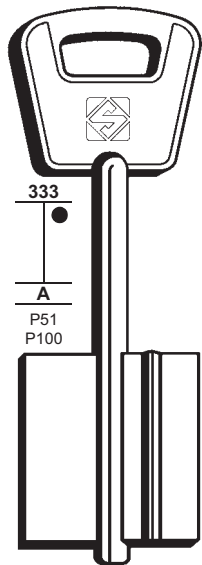

BEA



BEAC

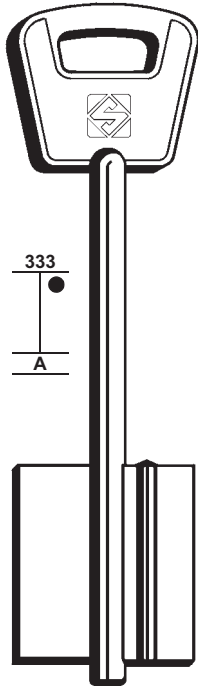

5BE2



5BE1

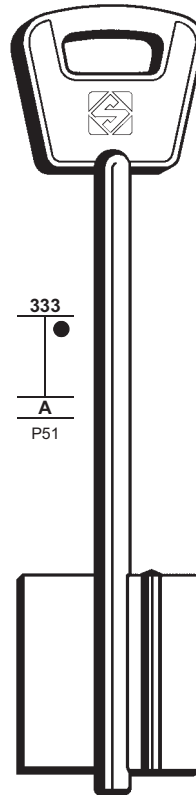

BEL



BELC

FOR:
PER:

BMC

BODA

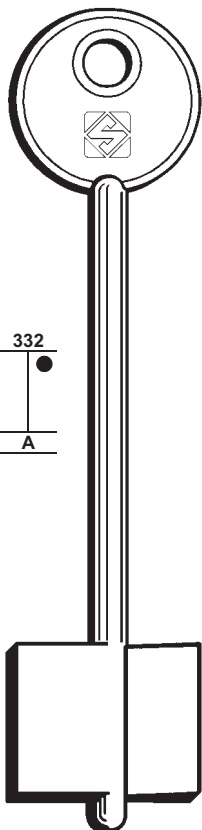

BL

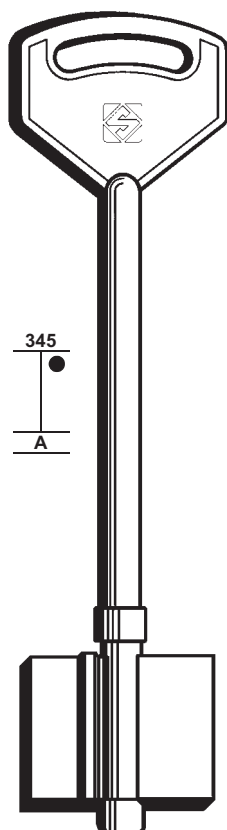

5BL1

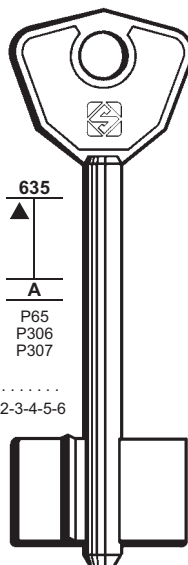

5BDA1
428

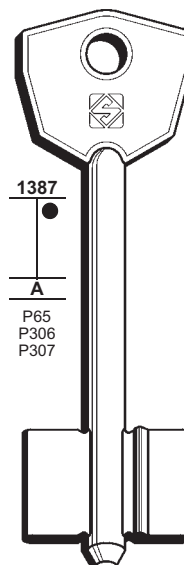

5BDA2

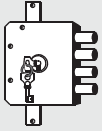

8

FOR/PER

BODA (FIN)

BODE (D)

+ (65-67)

FOR:

PER:

BODA

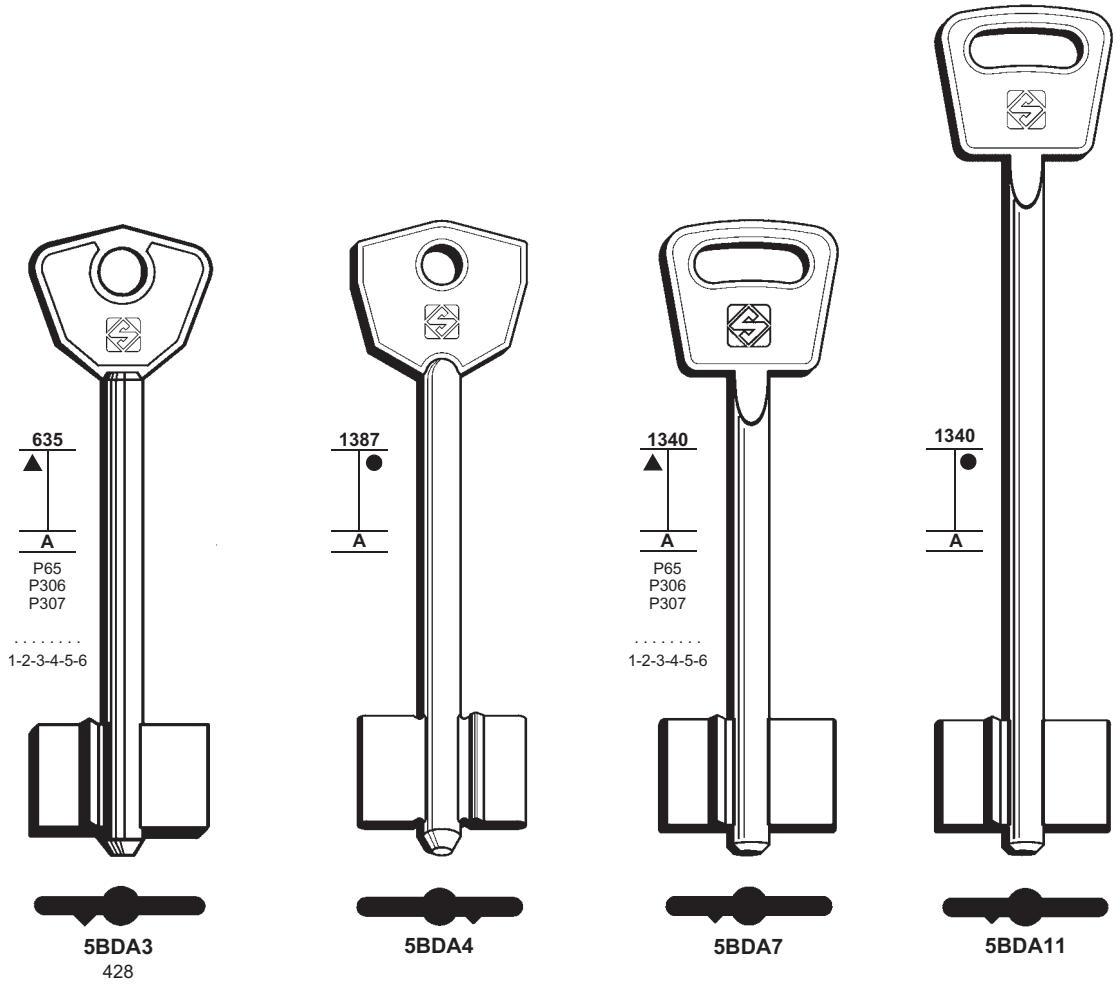

FOR:

PER:

BODE

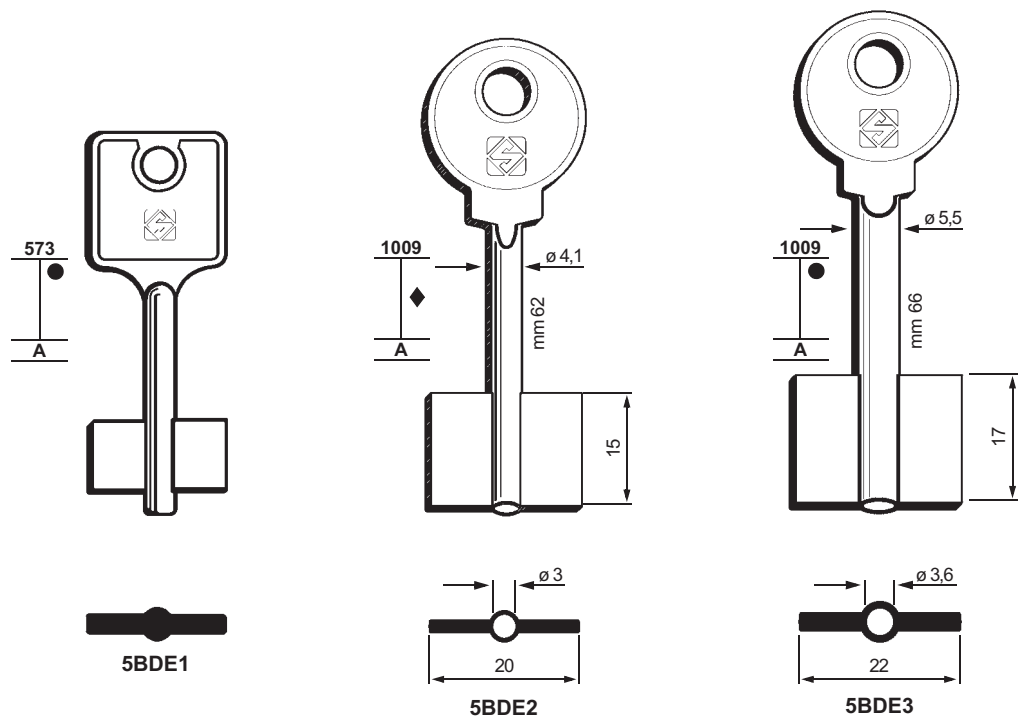

FOR:
PER:

BOGATIR

BURG-WÄCHTER

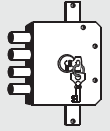

9

FOR/PER

BOGATIR (RUS)

BURG-WÄCHTER (D)
+ JUWEL (37)

CAF (I)

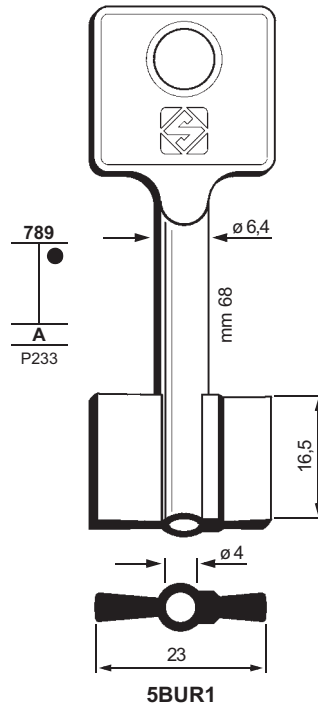
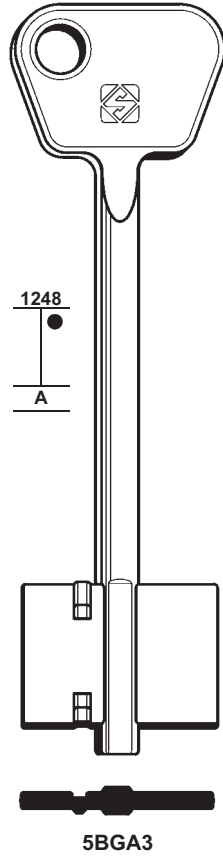
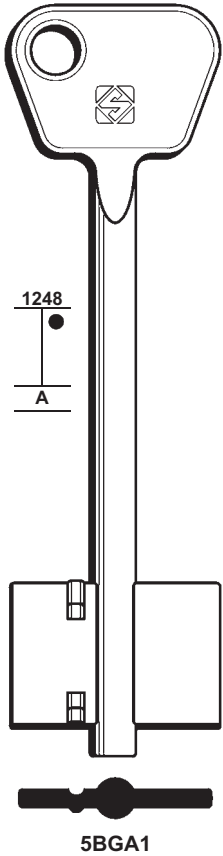

FOR:
PER:

BURG-WÄCHTER

CAF

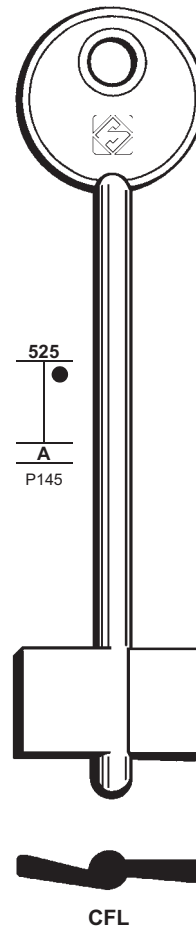
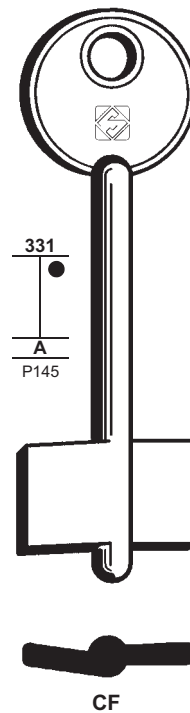
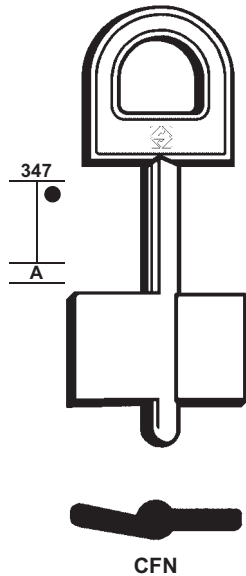
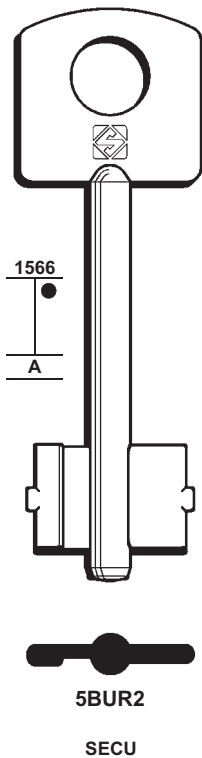

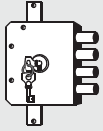

10

FOR/PER

CAM (RUS)

CECCHERELLI (I)

(69)

CENATA (RUS)

CERUTTI (I)

FOR:
PER:

CAM

CENATA

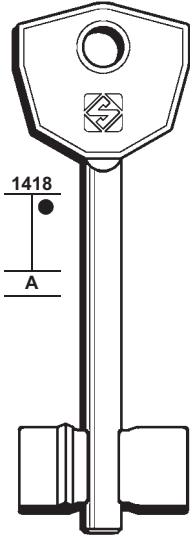

1418
A



5SMA1

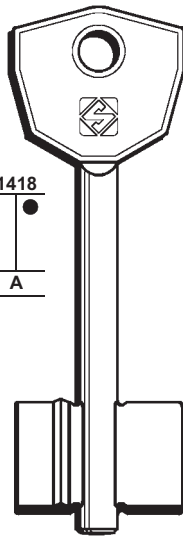

1418
A



5ACM1

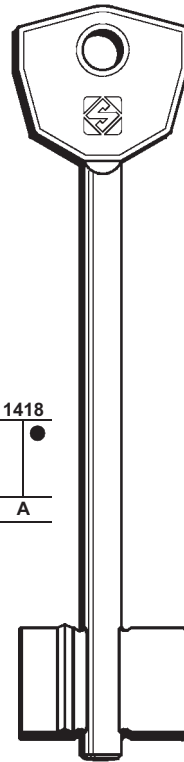

1418
A



5ACM3

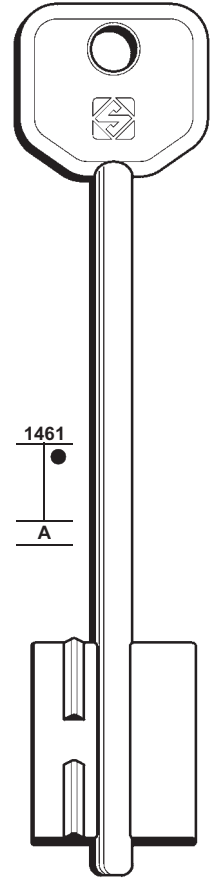

1461
A



5CTA1

FOR:
PER:

CERUTTI

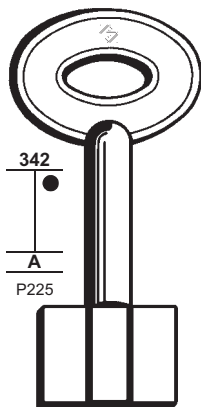

342
A
P225



CPC

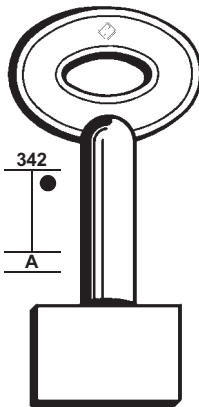

342
A



CPN

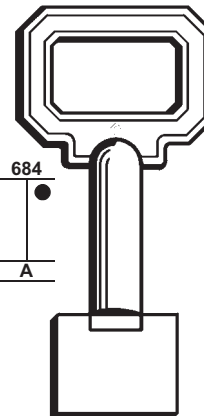

684
A



CPV

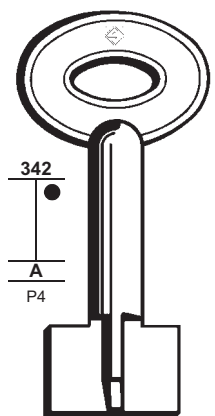

342
A
P4



CPX

FOR:
PER:

CERUTTI

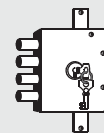

11

FOR/PER

CERUTTI (I)
CONFORTI
OSLA
VIRO

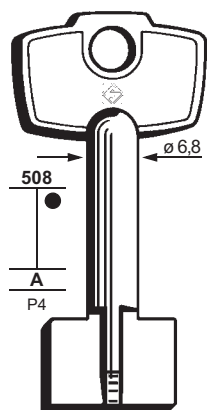

CPXN

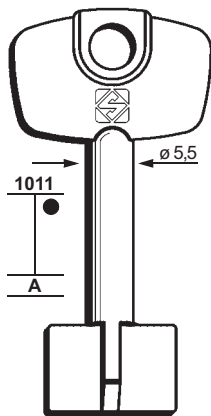

5C15

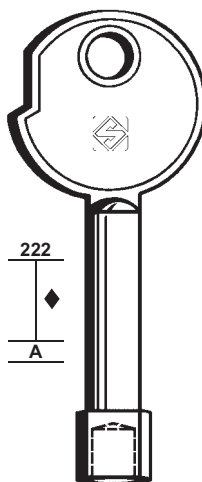

CM

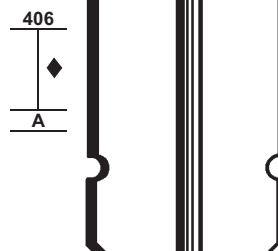

CPP

VIRO

FOR:
PER:

CERUTTI

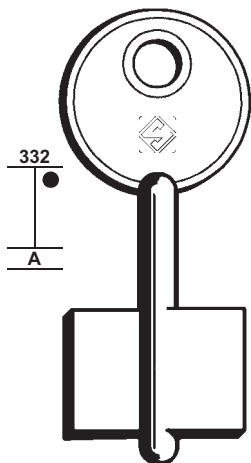

CCL

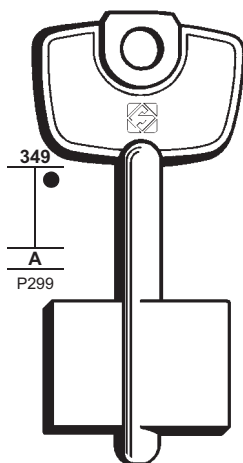

CCLQ

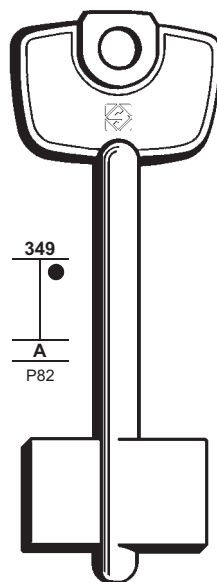

CQ

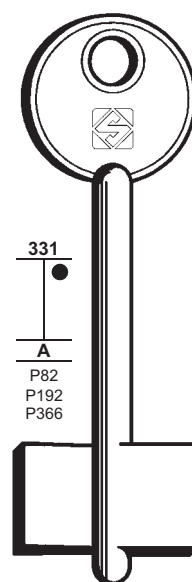

C



CC

CONFORTI - OSLA

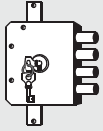

12

FOR/PER

CERUTTI (I)
CONFORTI
FEDELI
OSLA
VIRO

FOR:
PER:

CERUTTI

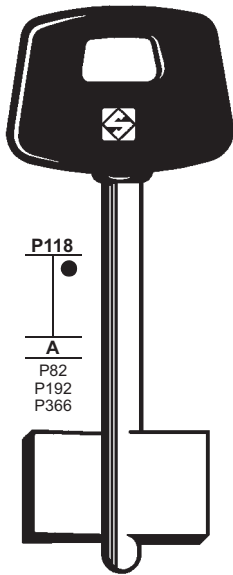

CP

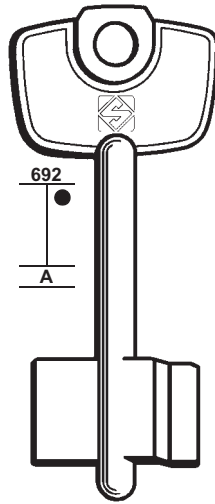

5C8

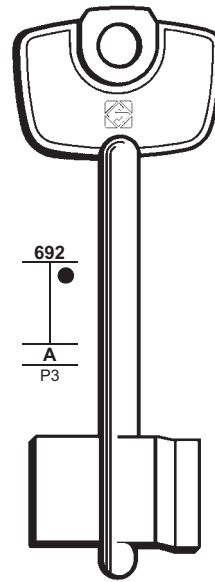

CN

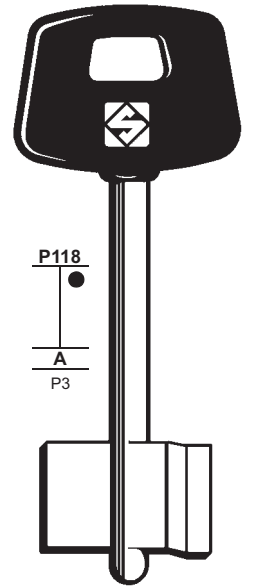

CNP



CNC



CNCP

CONFORTI - OSLA

VIRO

FOR:
PER:

CERUTTI

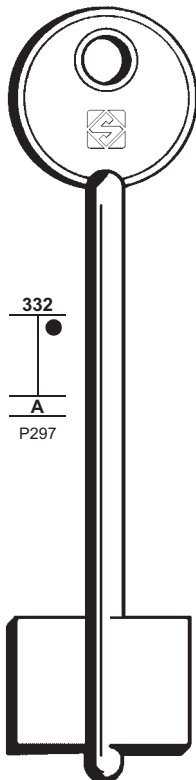

CLN

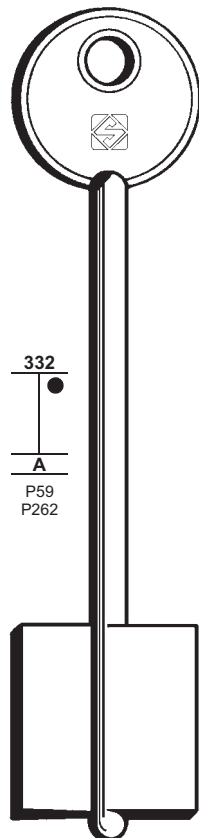

CL

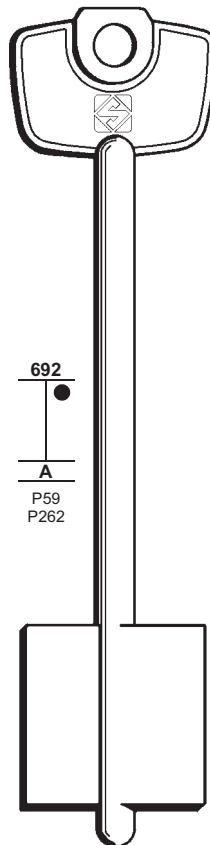

5C9

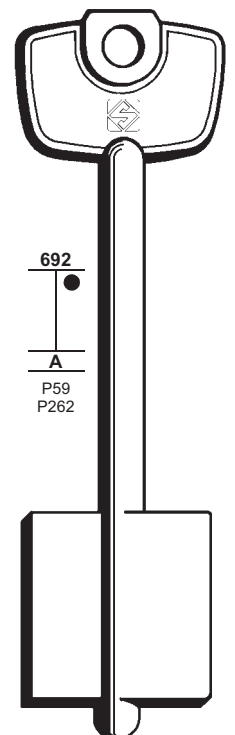

5C11

CONFORTI - FEDELI - VIRO

FOR:
PER:

CERUTTI

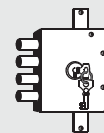

13

FOR/PER

CERUTTI (I)
FEDELI
VIRO

CIPIERRE (I)

CISA (I)

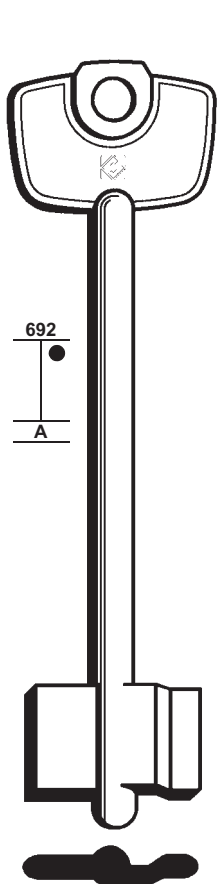

5C14
VIRO

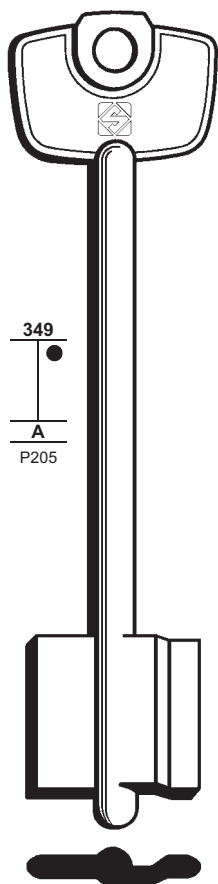

CLQ
FEDELI

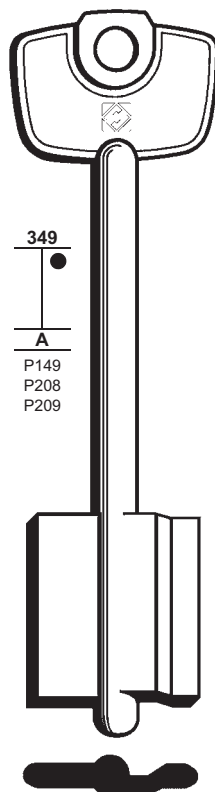

5C4
VIRO

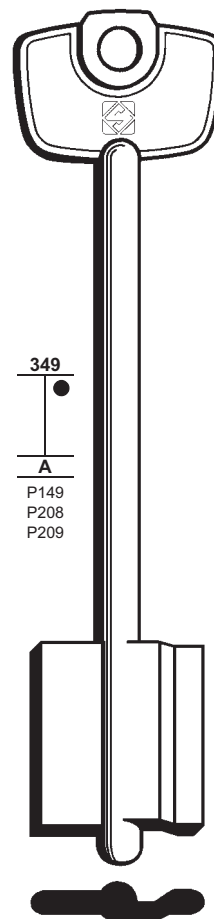

5C6

FOR:
PER:

CIPIERRE

CISA

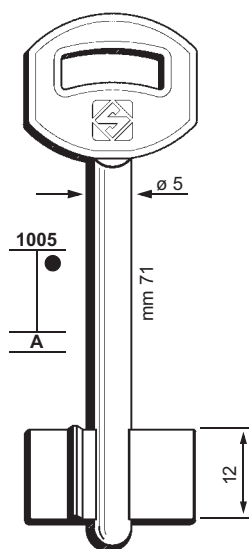

5CPR1

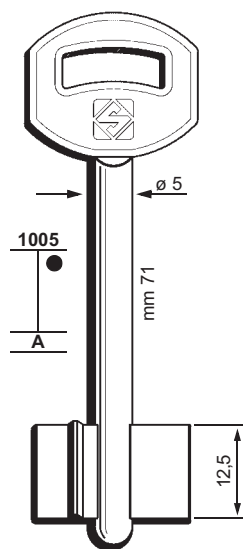

5CPR3

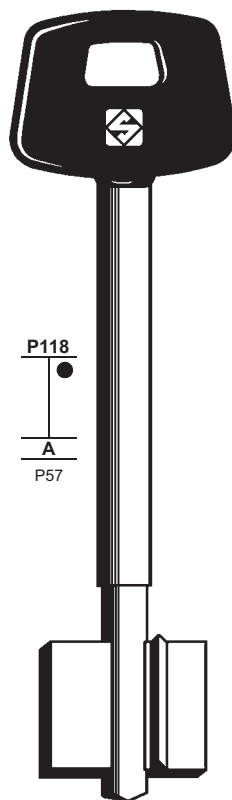

5CS8P

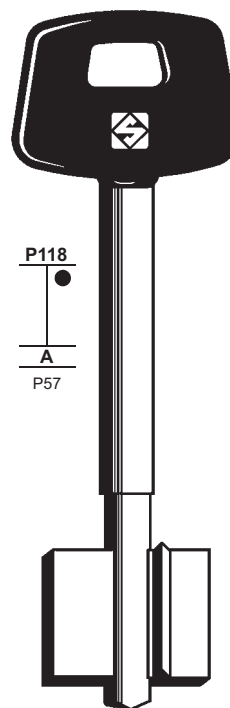

5CS6P

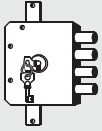

14

FOR/PER

CISA (I)
MCM
STAVER

FOR:
PER:

CISA

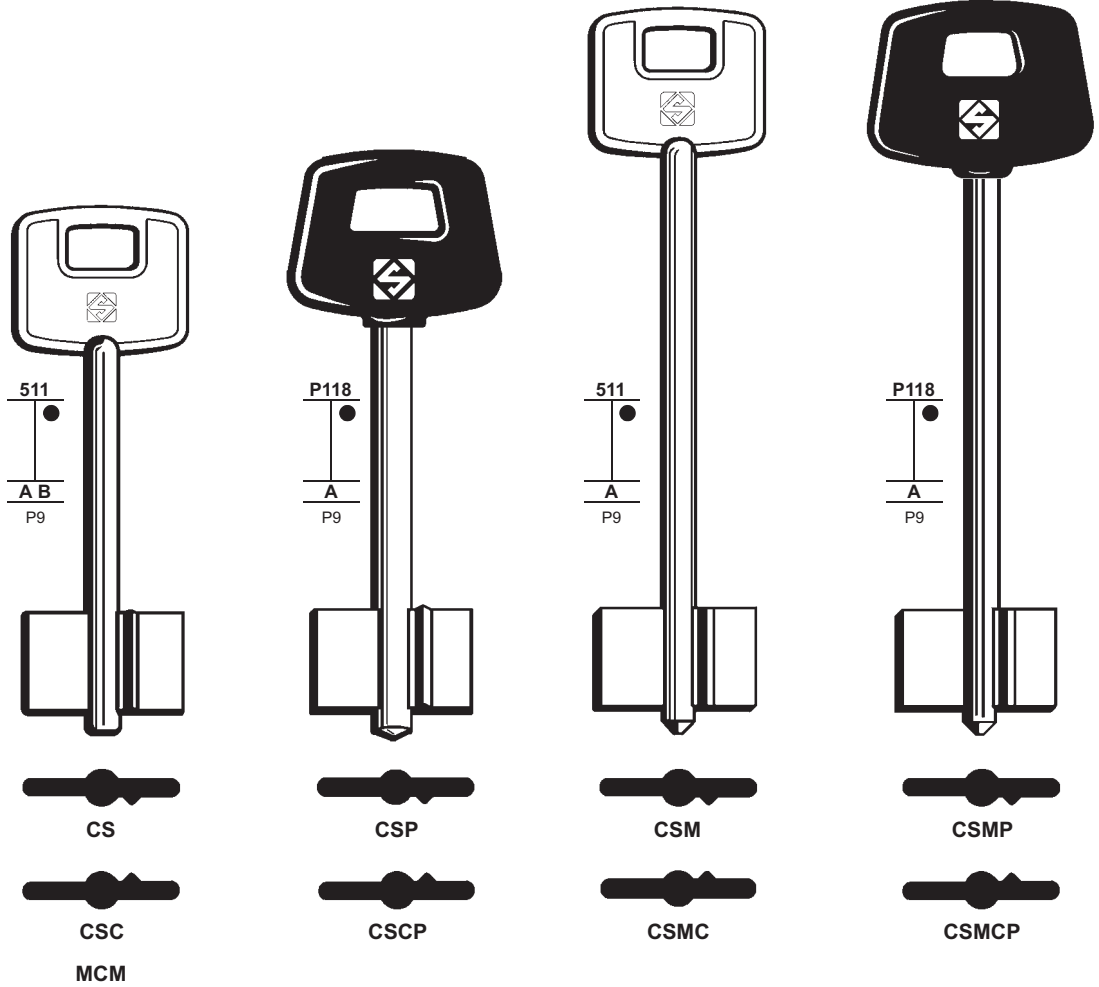

FOR:
PER:

CISA

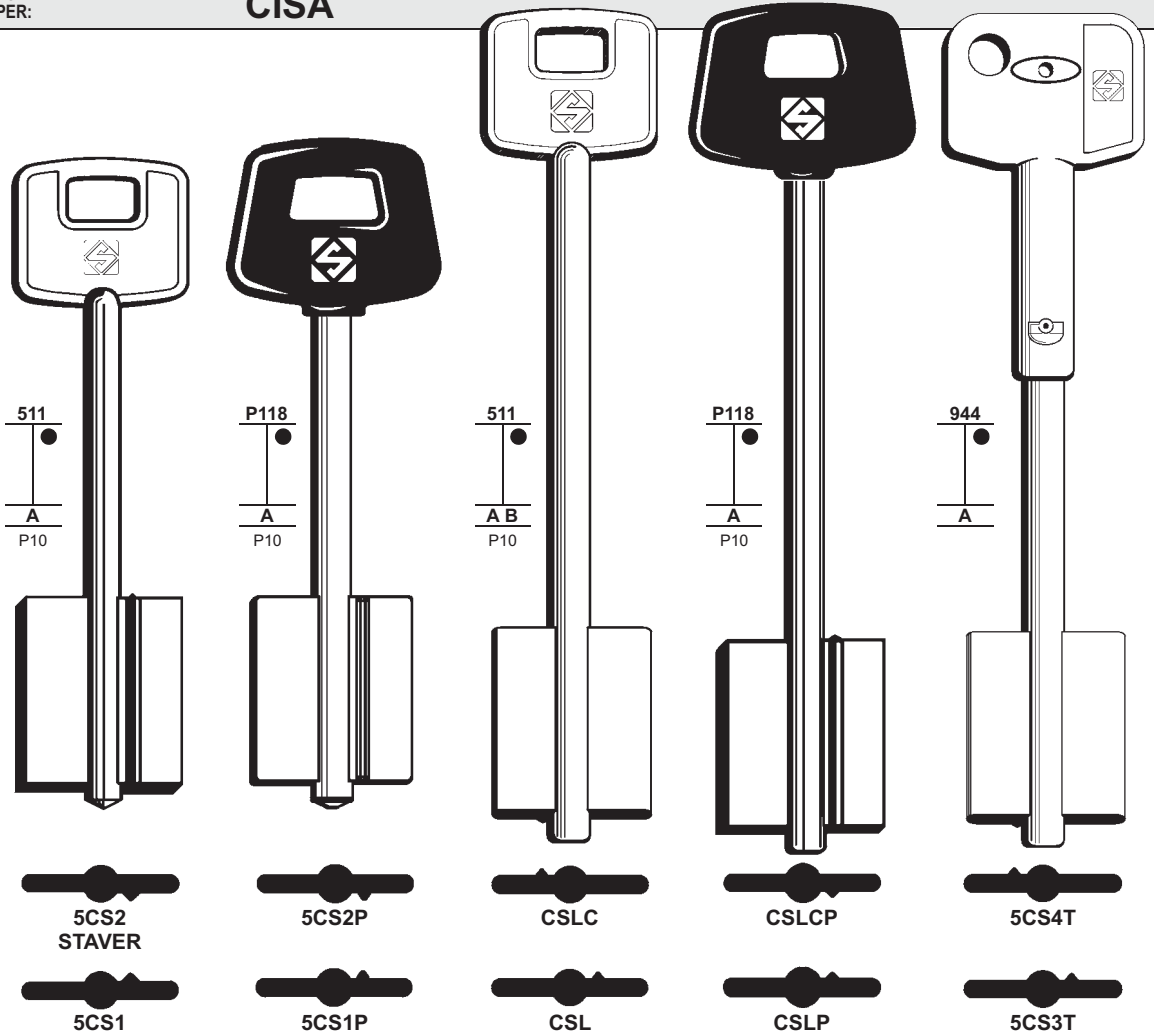

FOR:
PER:

CISA

CLASS



P118
A

P118
A
P253

1225
A

1225
A

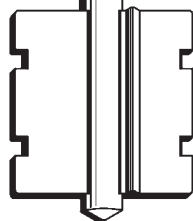
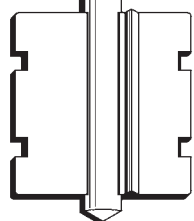

5CS12P

5CS10P

5CSS3

5CSS1

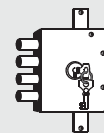

15

FOR/PER

CISA (I)

CLASS (RUS)

CONFORTI (I)

+ CERUTTI (11-12)

+ SIDERAL (56)

+ (71-72-73)

FOR:
PER:

CONFORTI

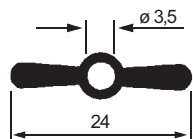
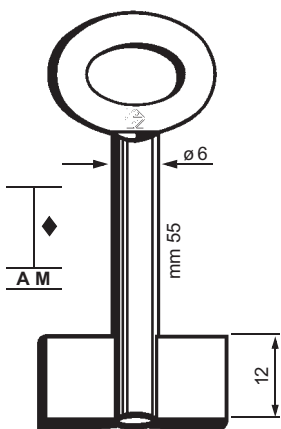

8405

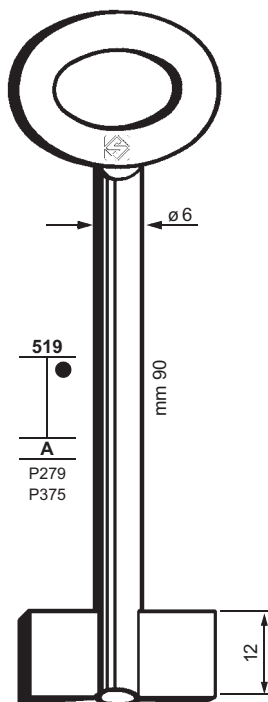

519
A
P279
P375

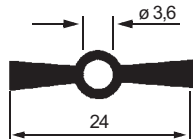

8388C

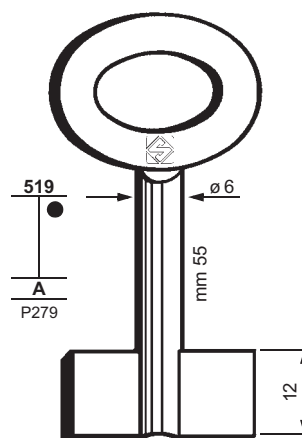

519
A
P279

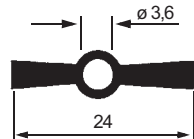

8355C

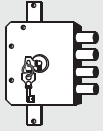

16

FOR/PER

CONFORTI (I)

- + CERUTTI (11-12)
- + SIDERAL (56)
- + (71-72-73)

CORBIN (I)

- + (76)

CORNI (I)

- GRODNO
- LINCE
- + SECUREMME (53)

FOR:
PER:

CONFORTI

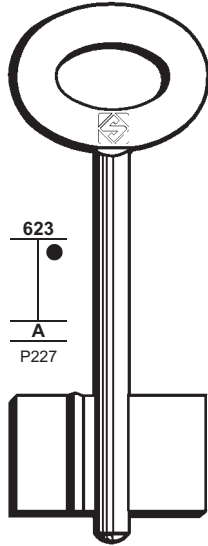

5CT1

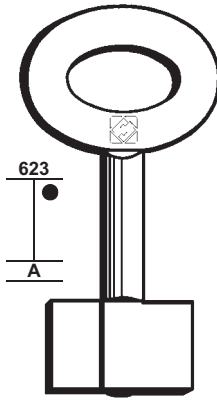

5CT3

CORBIN

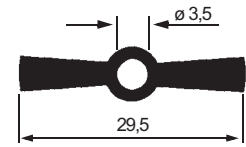
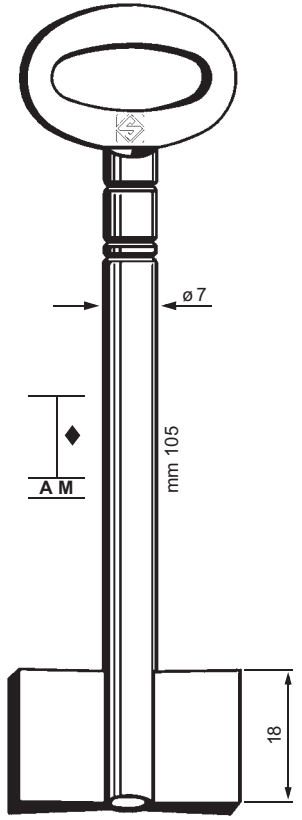

8711

FOR:
PER:

CORBIN

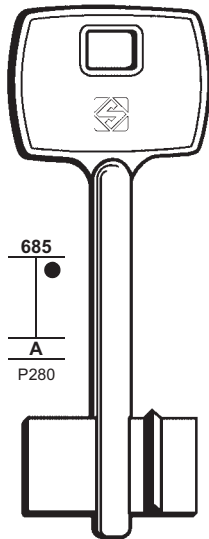

5CB2

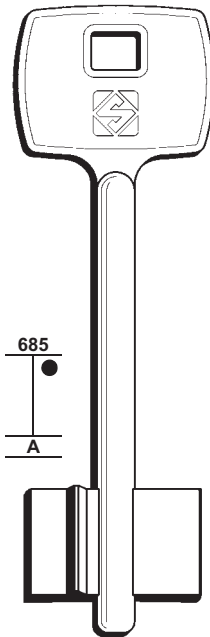

5CB3



5CB1

CORNI

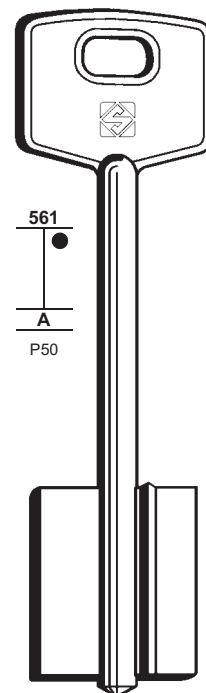

5CC4

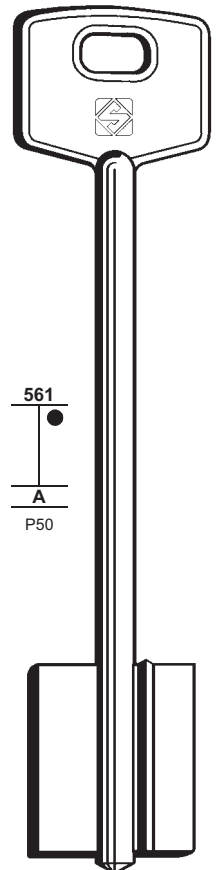

5CC2
LINCE GRODNO

FOR:
PER:

C.R.

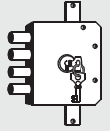

17

FOR/PER

C.R. (I)

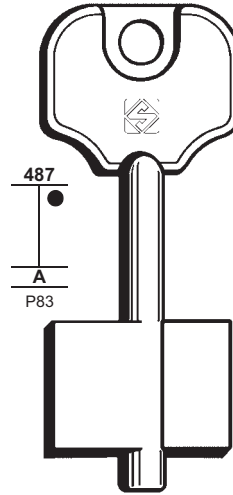
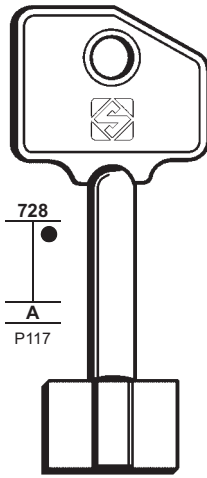
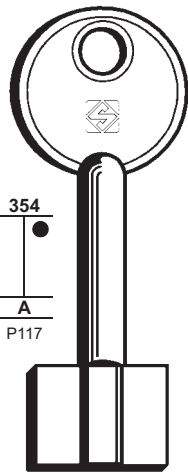
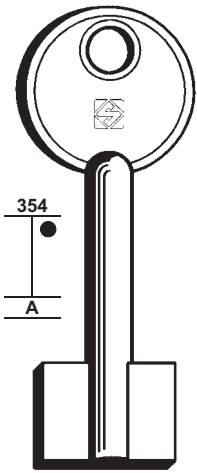

RP



RPC



5R7



RN

FOR:
PER:

C.R.

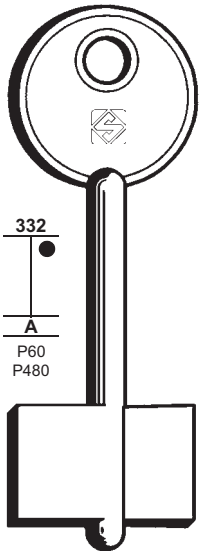

R



RF



RFO

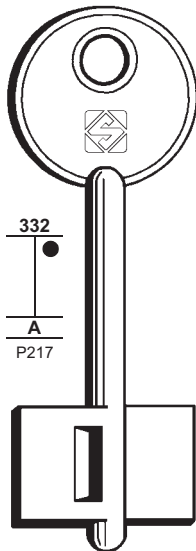

5R2

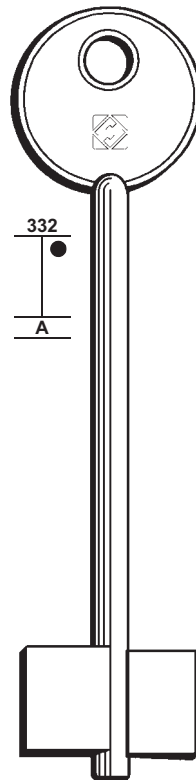

RM

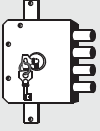

18

FOR/PER
C.R. (I)

FOR:
PER:

C.R.

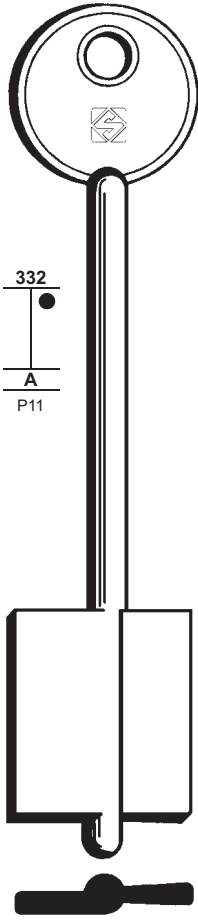

RL

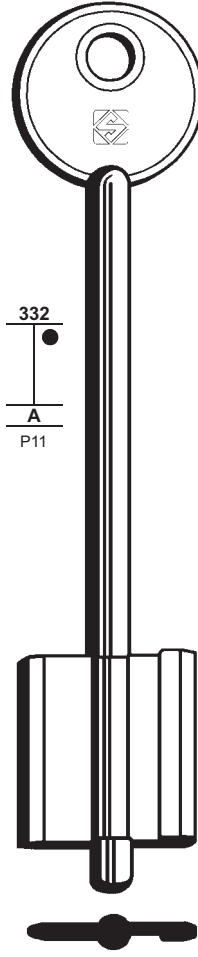

RLN

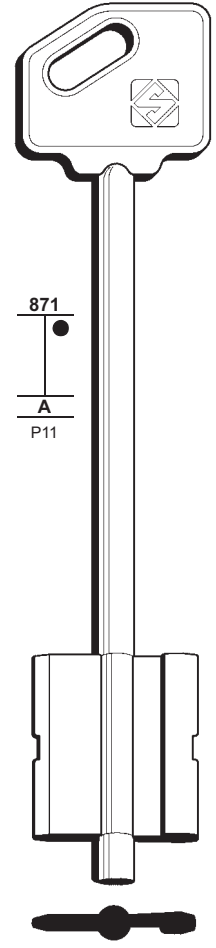

5R16

FOR:
PER:

C.R.

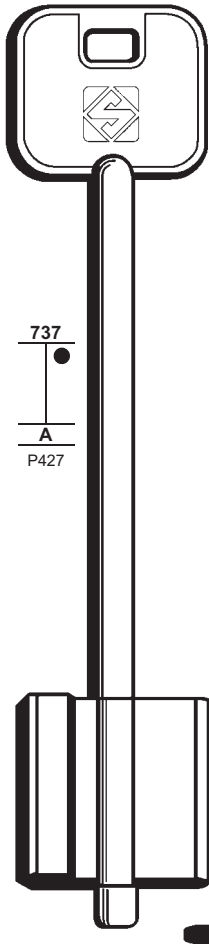

5R9

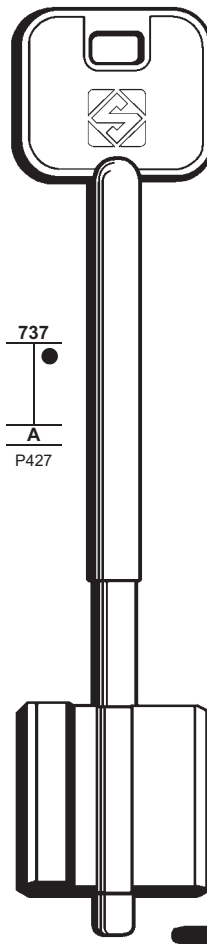

5R11

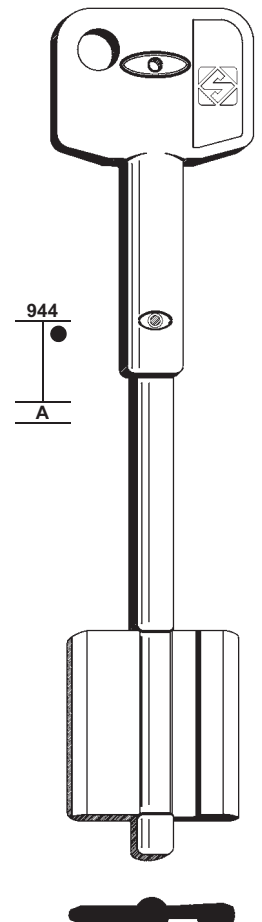

5R12T

FOR:
PER:

C.R.

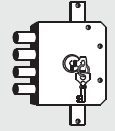

19

FOR/PER

C.R. (I)

DEKABA (BG)
MAUER

DENY (F)

DOMUS (I)
FACEF (27)

DUTO (I)
(77-78)

DUPLEX (RUS)

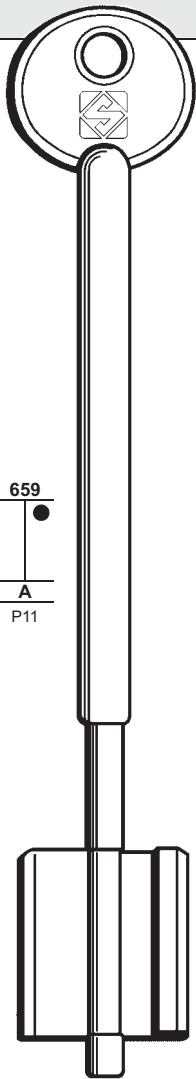

659
A
P11



5R6

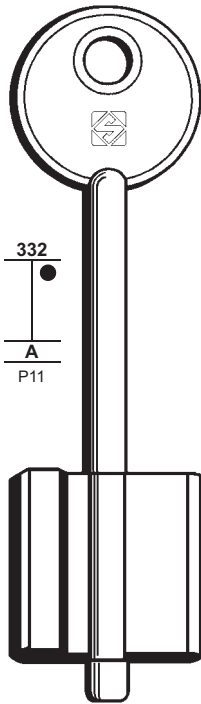

332
A
P11



RLCR



RLC

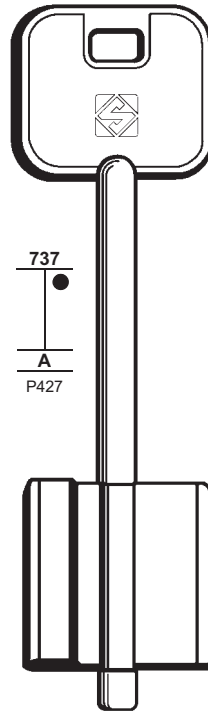

737
A
P427



5R3

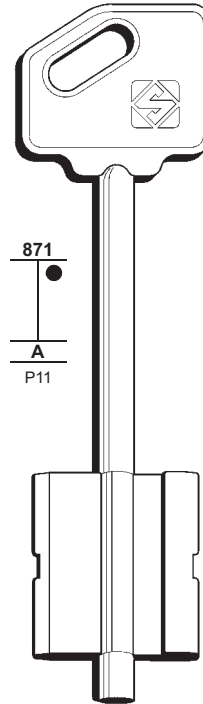

871
A
P11



5R14

FOR:
PER:

DEKABA

DENY

DUPLEX

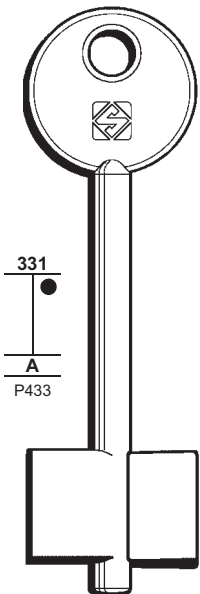

331
A
P433



5DK1
MAUER

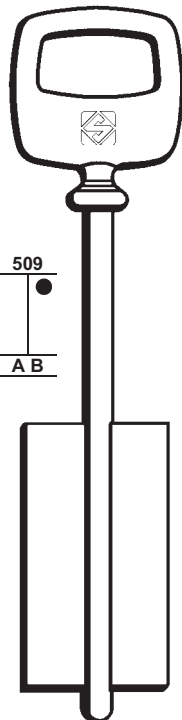

509
A B



5DY1

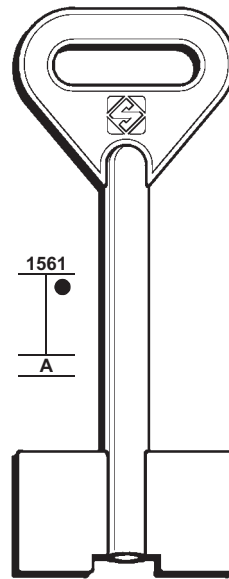

1561
A



5DUX2

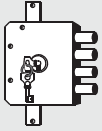

20

FOR/PER
DVERNIAK (RUS)

FOR:
PER:

DVERNIAK

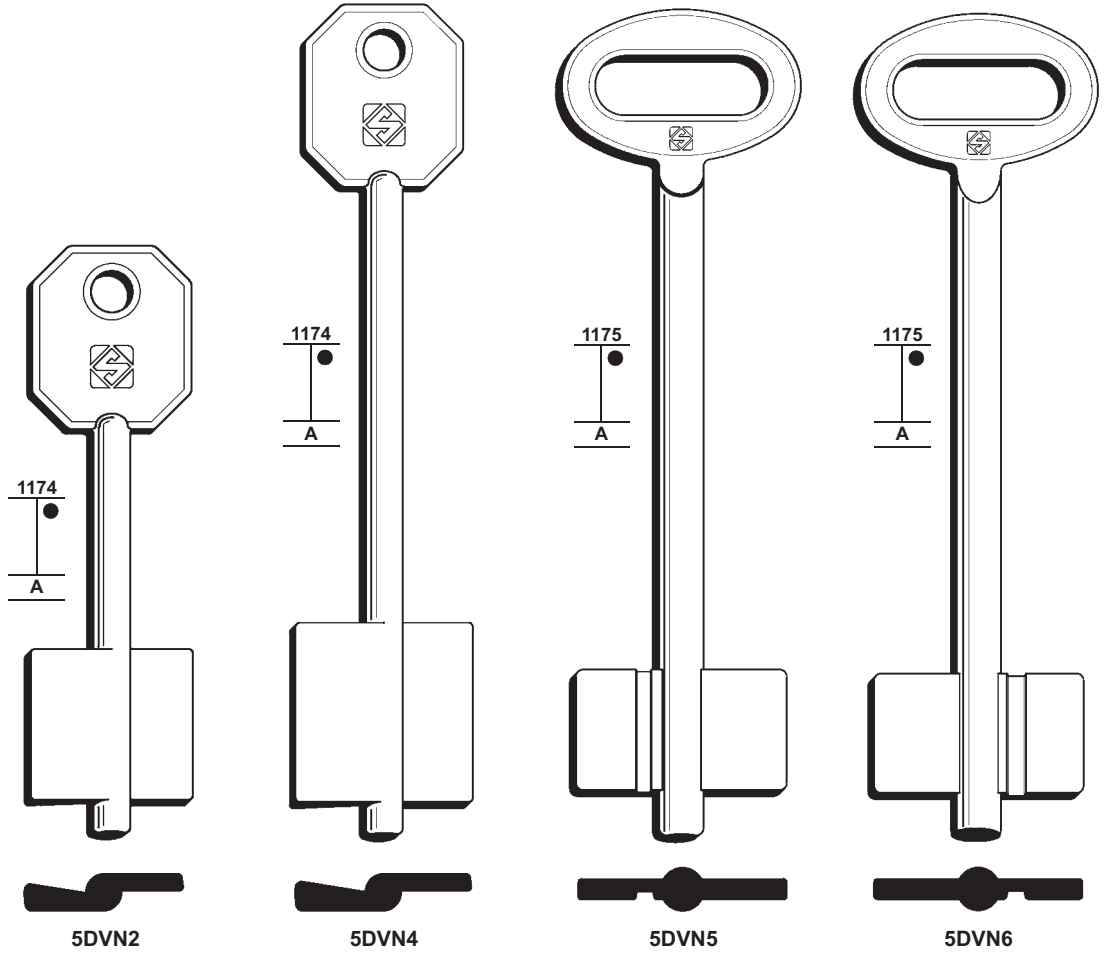

FOR:
PER:

DVERNIAK

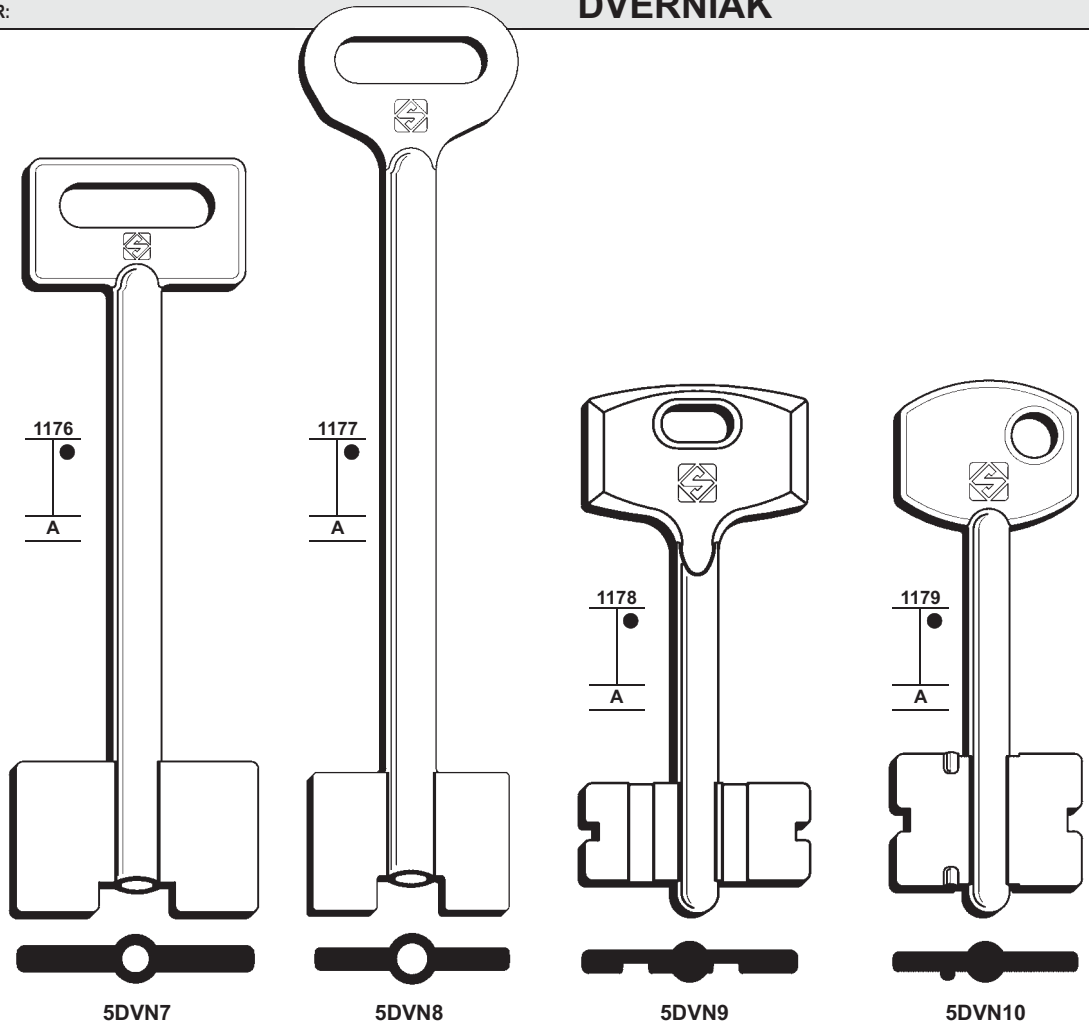

FOR:
PER:

DVERNIAK

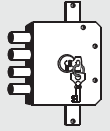

21

FOR/PER

DVERNIAK (RUS)

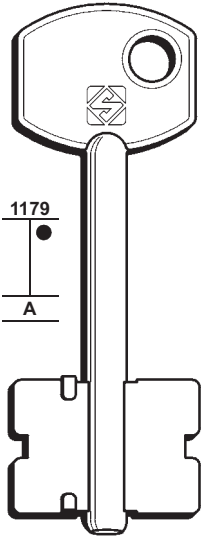

5DVN10F

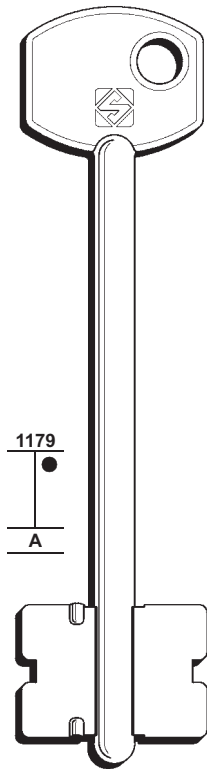

5DVN12

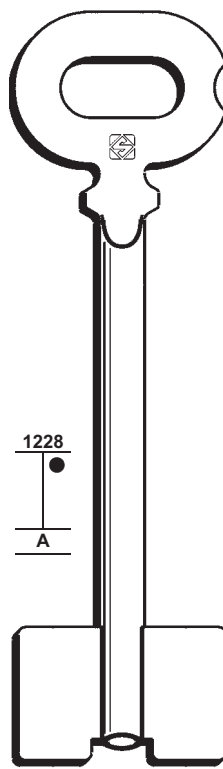

5DVN15

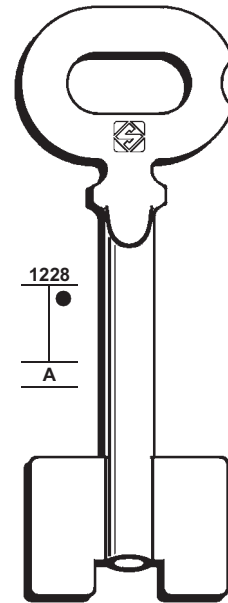

5DVN14



FOR:
PER:

DVERNIAK

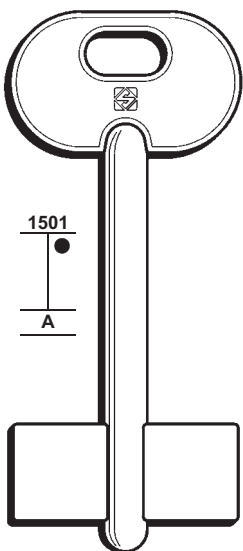

5DVN22

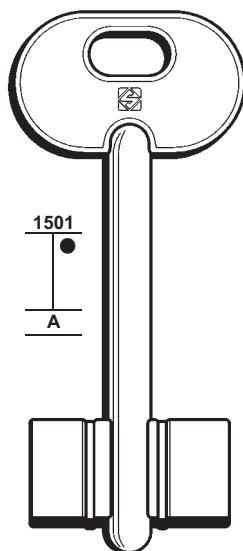

5DVN23

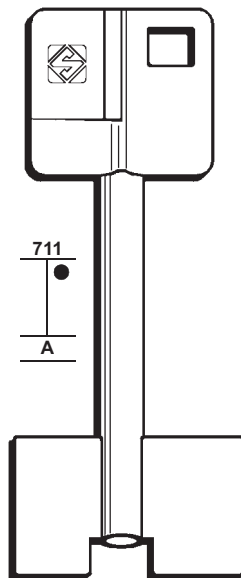

5DVN24

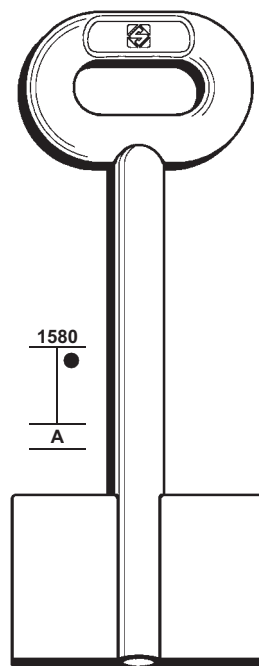

5DVN25

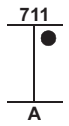
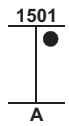
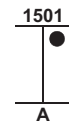

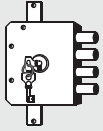

22

FOR/PER

DVERNIAK (RUS)

ELZETT (H)

+ 👁️ (70)

FOR:
PER:

DVERNIAK

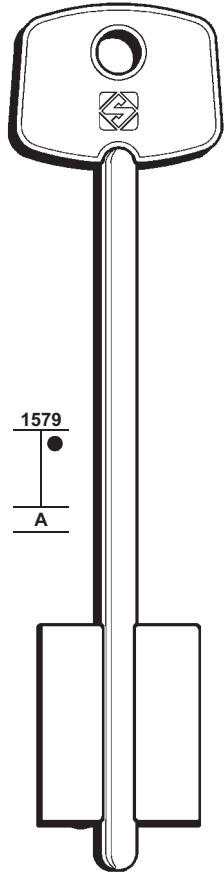

5DVN26

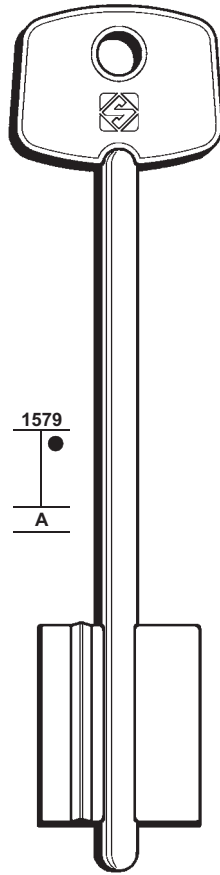

5DVN27

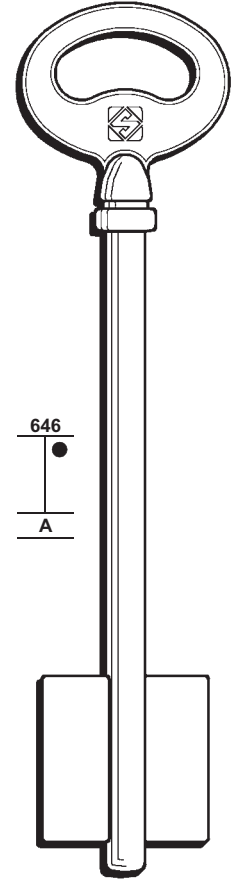

5DVN34

FOR:
PER:

DVERNIAK

ELZETT

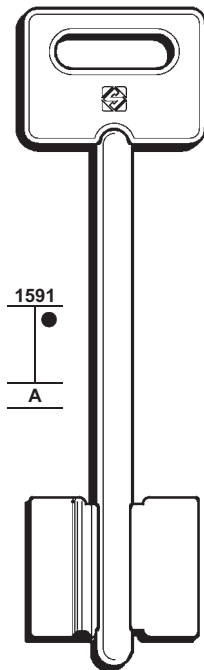

5DVN29

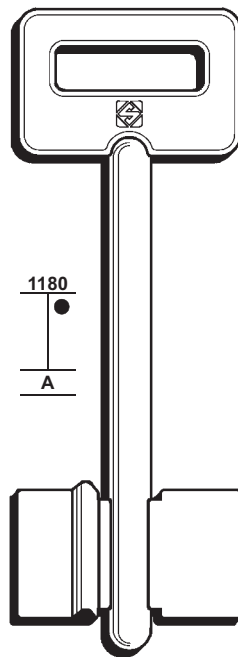

5DVN31

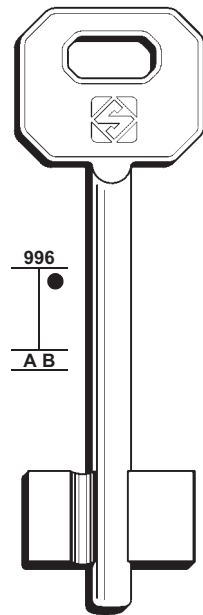

5EL1

FOR:
PER:

ELZETT

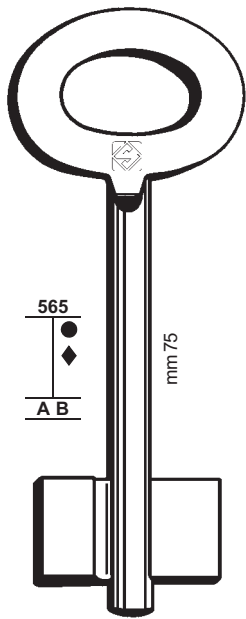

7308E

ELBOR

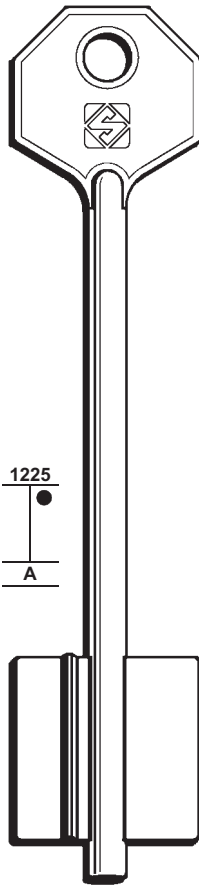

5DVN19

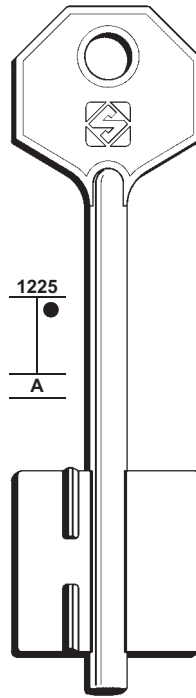

5DVN17

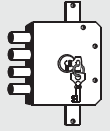

23

FOR/PER

ELZETT (H)
+ (70)

ELBOR (RUS)

EMME (I)
 SECUREMME (53)

FOR:
PER:

ELBOR

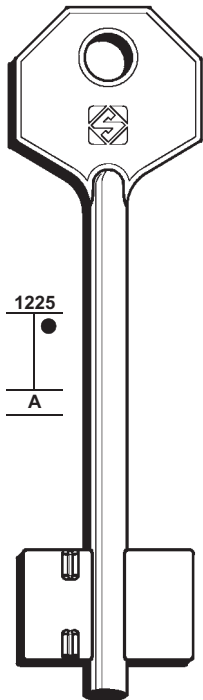

5EB2

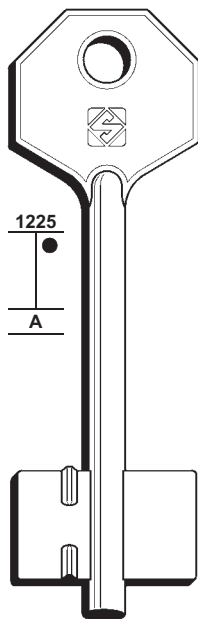

5DVN21

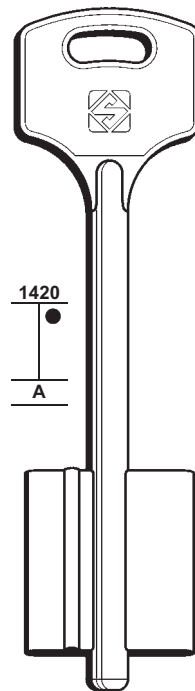

5EB1

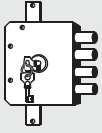

24

FOR/PER

EREVAN (AZ)

ESETY (I)
TESIO

FOR:
PER:

EREVAN

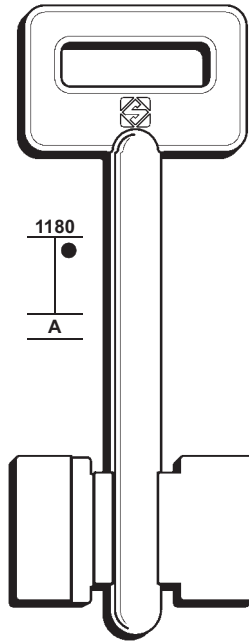

1180
A



5ERV1

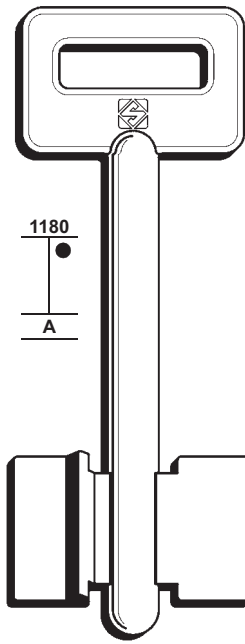

1180
A



5ERV3

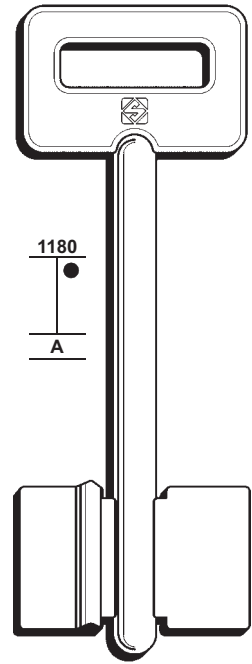

1180
A



5ERV5

FOR:
PER:

ESETY

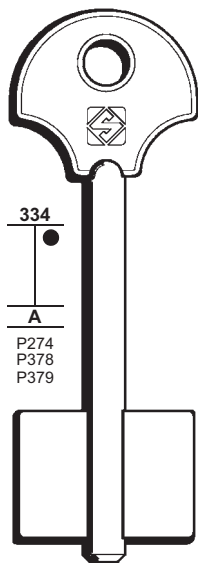

334
A



E

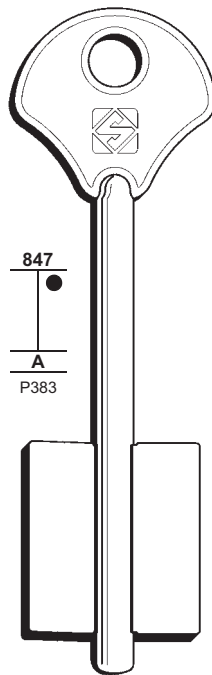

847
A
P383



EN

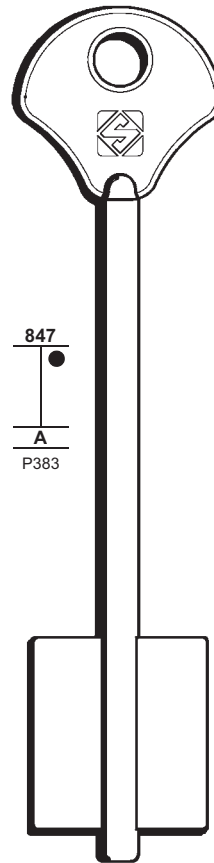

847
A
P383



EL

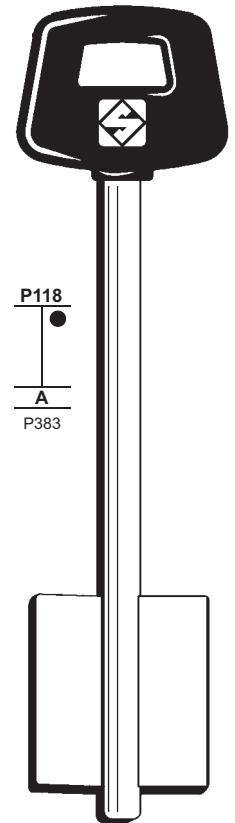

P118
A
P383



ELP

TESIO

FOR:
PER:

ESETY

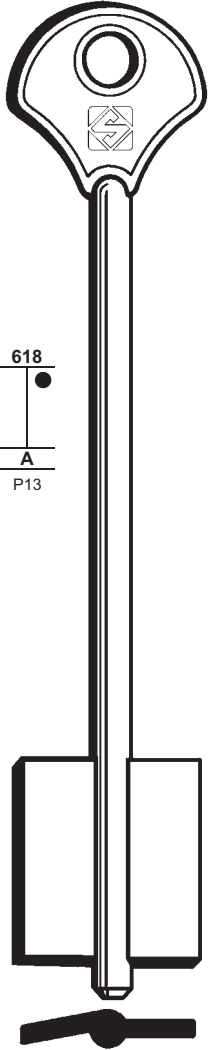

5EY1

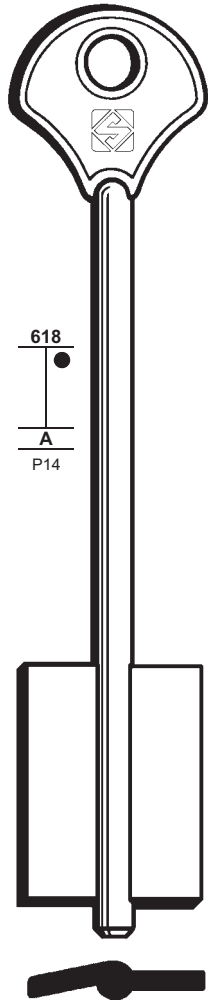

5EY3
ISMET

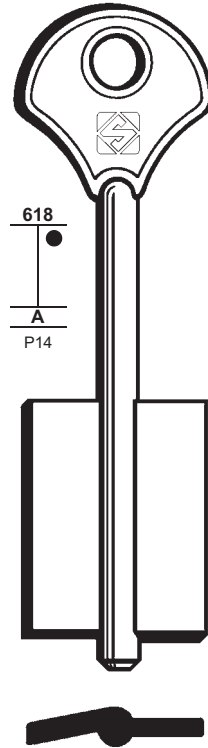

5EY5

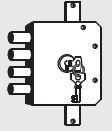

25

FOR/PER

ESETY (I)
ISMET

FOR:
PER:

ESETY

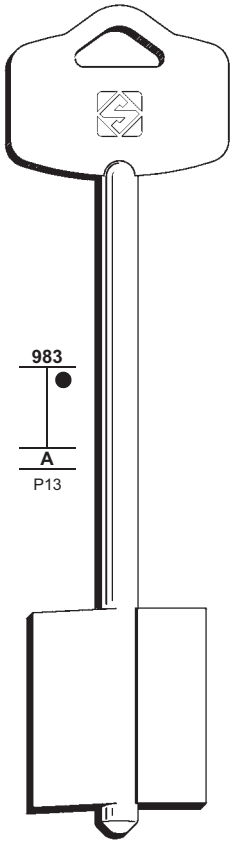

5EY22

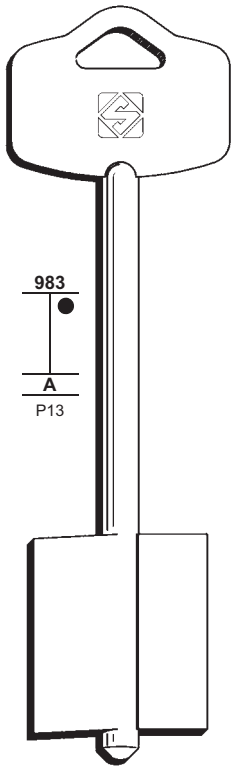

5EY24

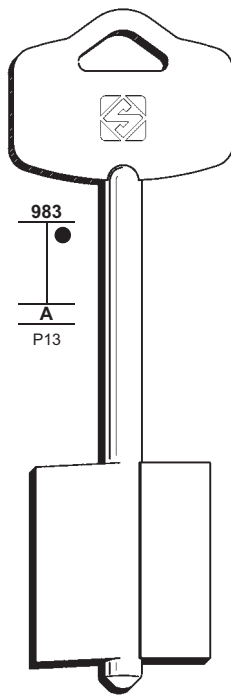

5EY20

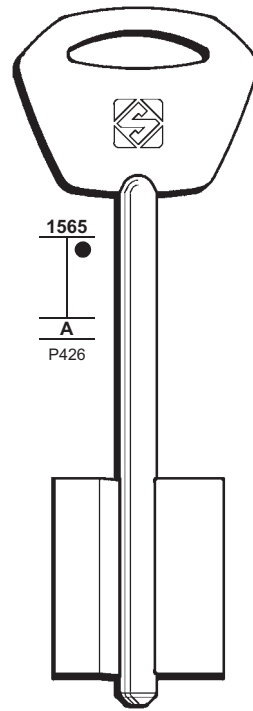

5EY32

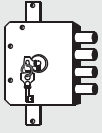

26

FOR/PER

ESETY (I)

ET (I)

⊗ POTENT (49)

EZCURRA (E)

FOR:
PER:

ESETY

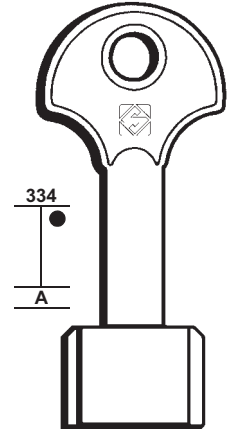
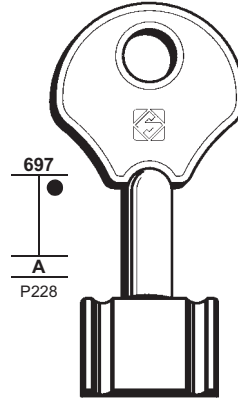
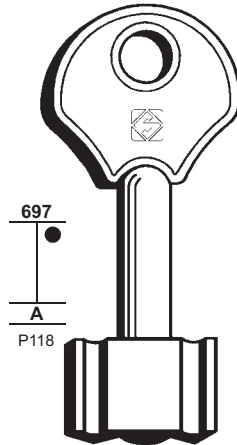
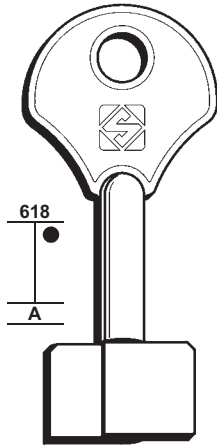

EP



EPN



EPP



EPT

FOR:
PER:

EZCURRA

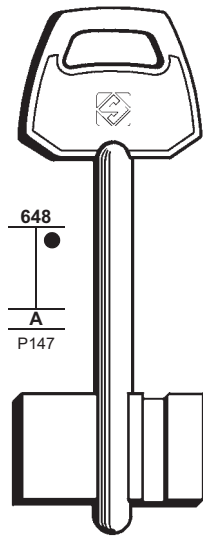

648

A
P147

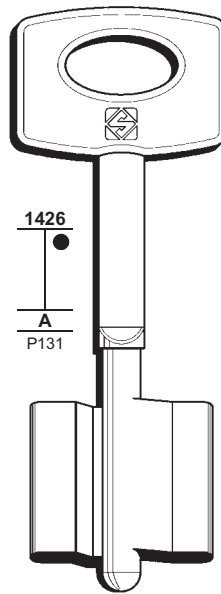

1426

A
P131

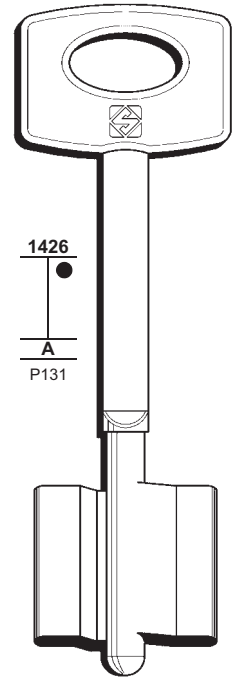

1426

A
P131



5EZ2



5EZ1



5EZ4



5EZ6

FOR:
PER:

FAC

FACEF - DOMUS

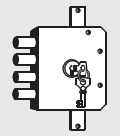

27

FOR/PER

FAC (E)

FACEF (I)
BLINKOR
DOMUS
GUARDIAN

FASEM (I)
IDM (34-35)

FASTA (I)
+ IDM (67)

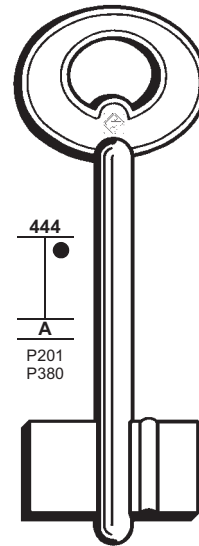
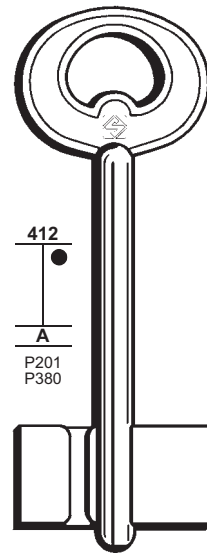
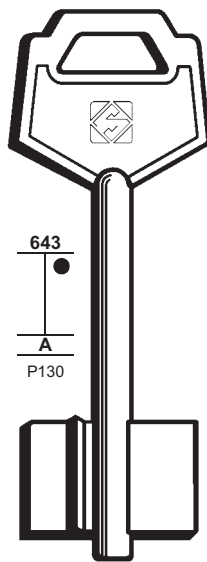
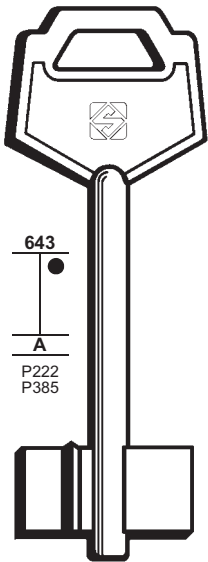

5FAC1



5FAC3



DS



FD

BLINKOR - DOMUS - GUARDIAN

FOR:
PER:

FASTA

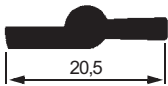
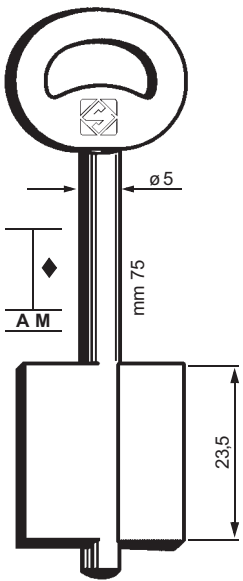

7150

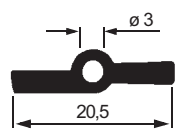
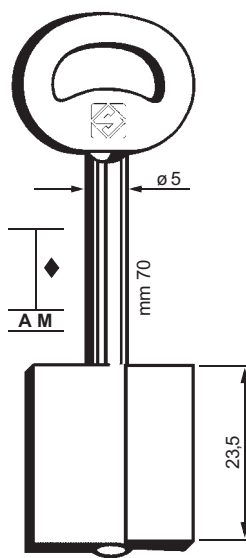

8150

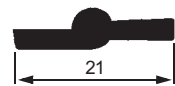
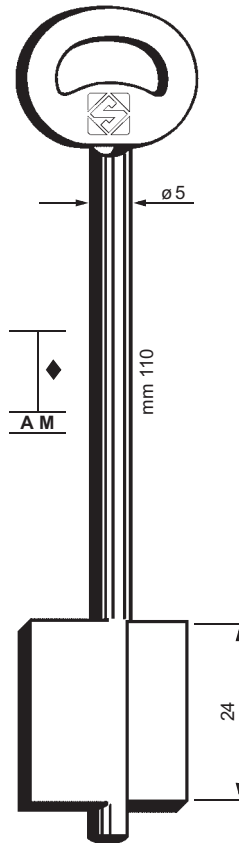

7151

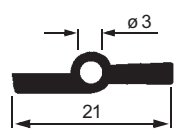
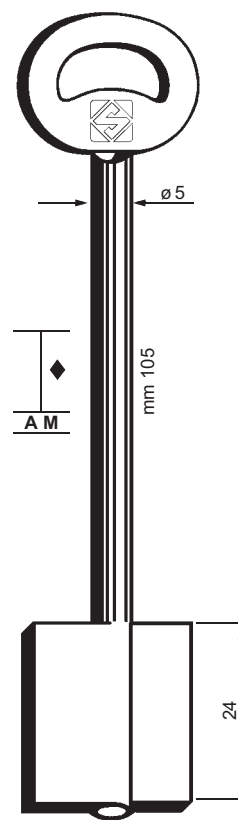

8151

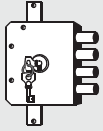

28

FOR/PER

FEB (I)
VIRO (I)
YALE

FEDELI (I)
CERUTTI (12-13)
MOTTURA (42)

FERRAMETALL (I)

FETIS (E)

FIAM (I)
+ IDM (35)

FOR:
PER:

FEB

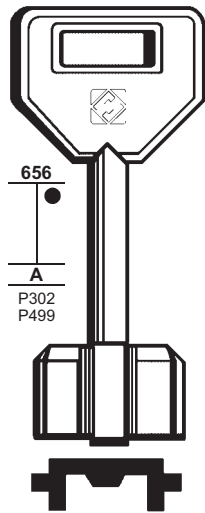

5FEB5
VIRO - YALE

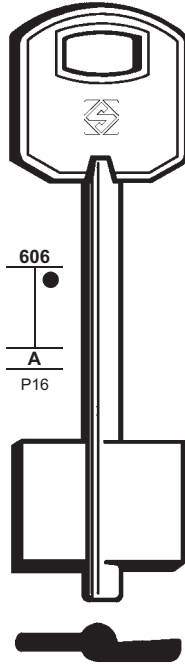

5FEB1

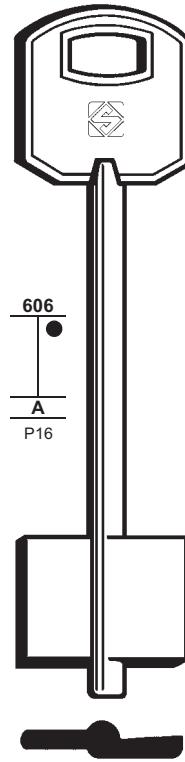

5FEB7

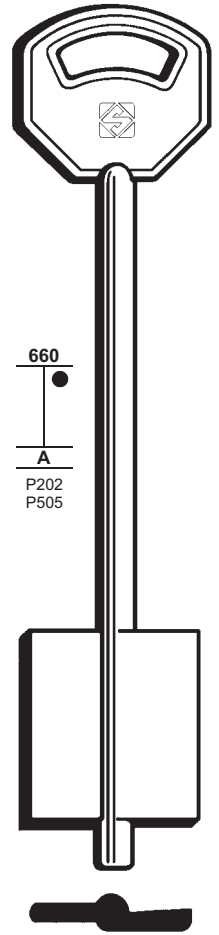

5FEB3
VIRO

FOR:
PER:

FERRAMETALL

FETIS

FIAM

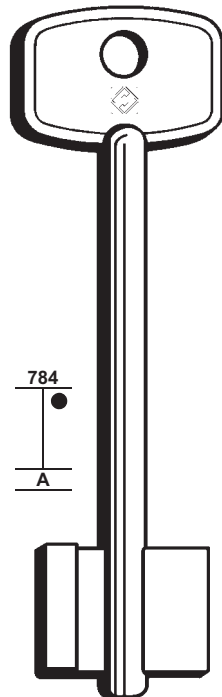

5FR1

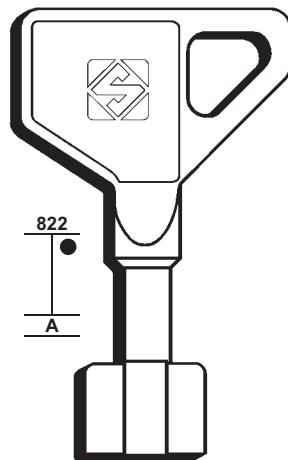

5FE1

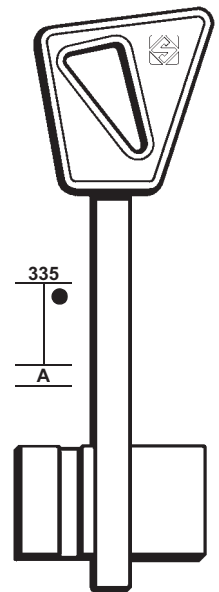

FQ

FOR:
PER:

FIAM

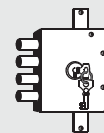

29

FOR/PER

FIAM (I)

+ IDM (34)

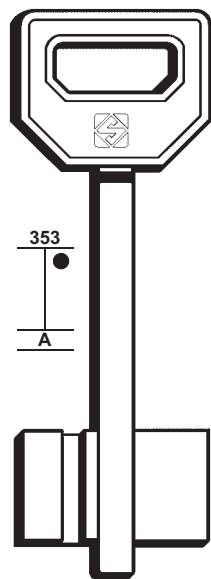

FQN

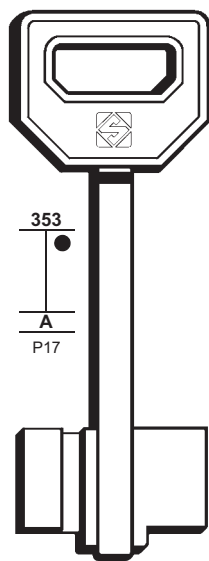

5F15

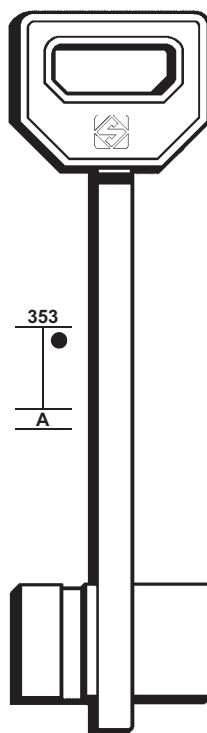

FQC

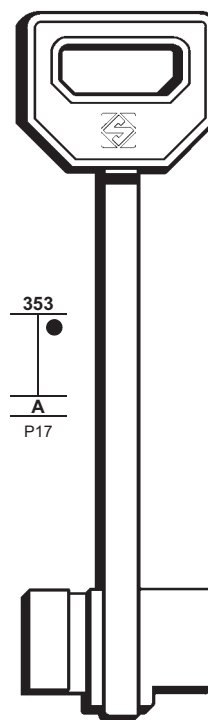

5F17

FOR:
PER:

FIAM

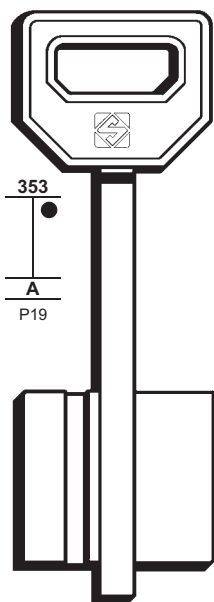

5F13

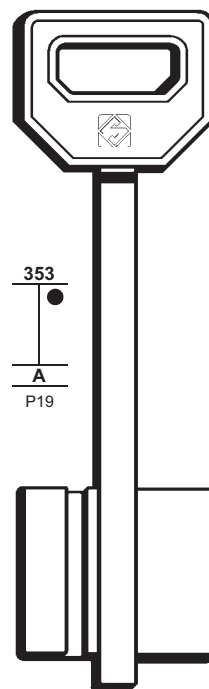

FQM

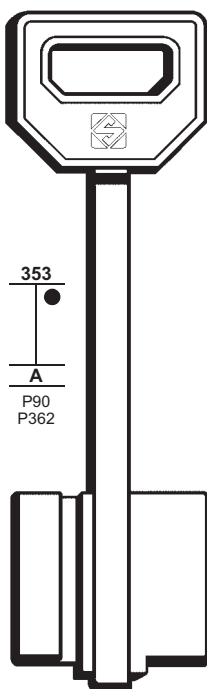

5F19

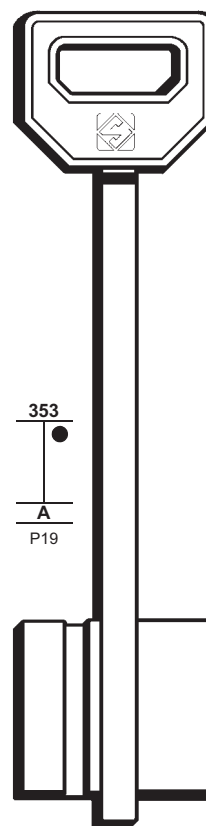

FQL

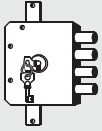

30

FOR/PER

FIAM (I)

+ IDM (34)

FOR:

PER:

FIAM

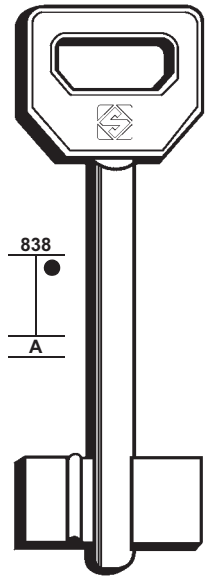
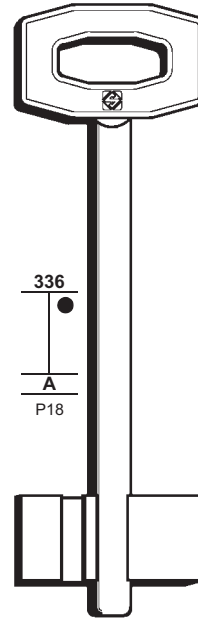
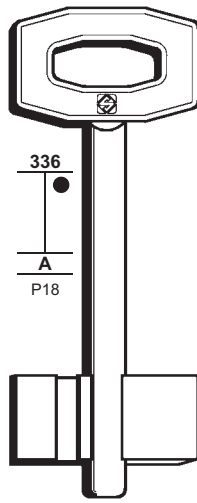
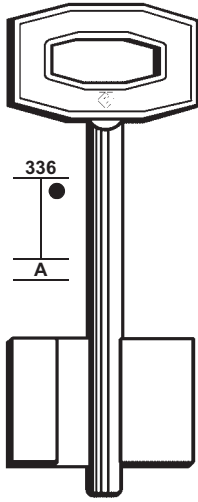

FOR:
PER:

FIAM

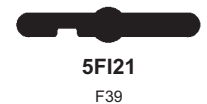
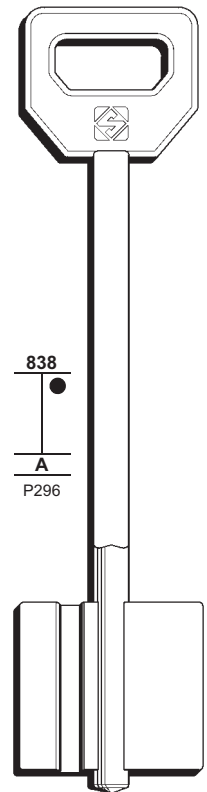
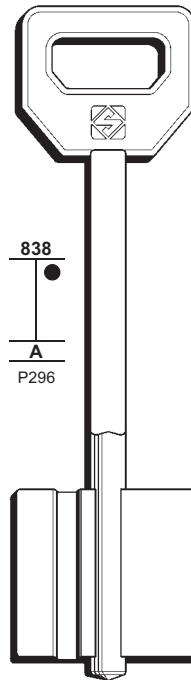
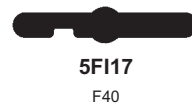
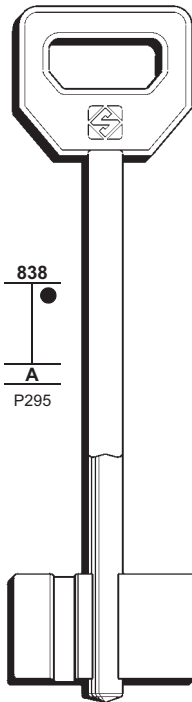
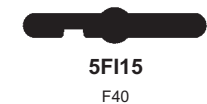
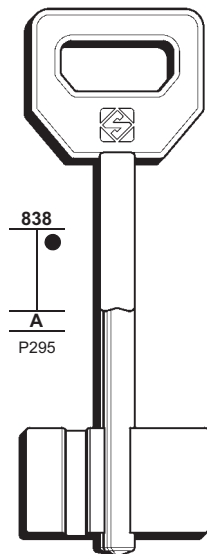

FOR:
PER:

FIAM



Blue head
Testa blu

P428

A
P429

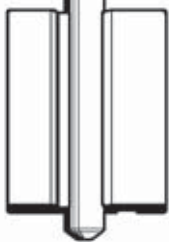

5FI23P

FIAMCA



332

A

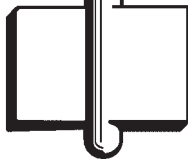

5FC1

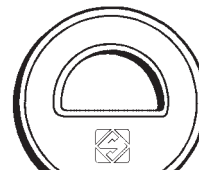

758

A

mm 73,5

ø 5,8



15,5

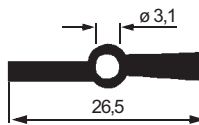

ø 3,1

26,5

5FC4

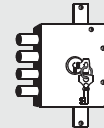

31

FOR/PER

FIAM (I)
+ IDM (34)

FIAMCA (I)

FICHET (F)

FOR:
PER:

FICHET

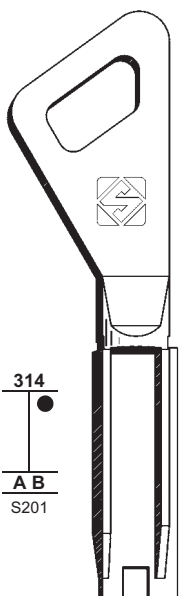

314

A B
S201



FT500

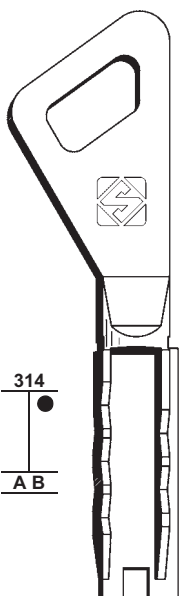

314

A B



FT500C

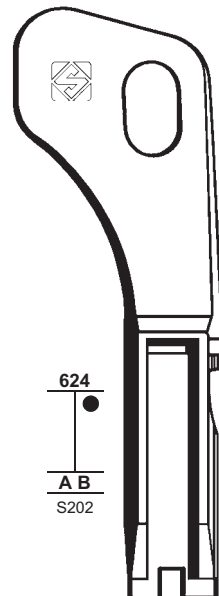

624

A B
S202



FT510

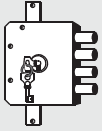

32

FOR/PER
FICHET (F)
FUMEO (I)
PARMA
+ (66-69)

FOR:
PER:

FICHET

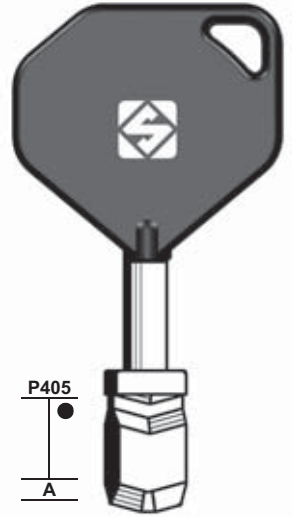
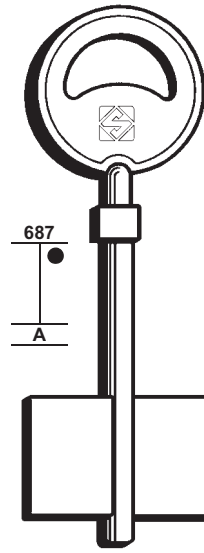
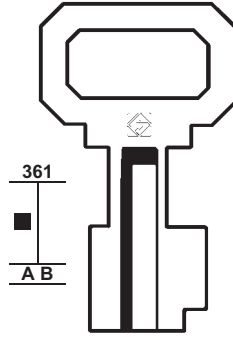
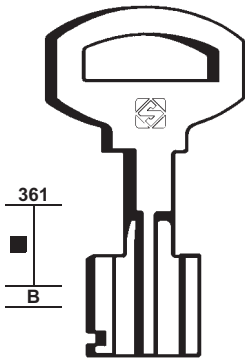

FT7

FT8



FT11

FT12



5FT2



FT525P



FT9



FT14



5FT1



FOR:
PER:

FUMEO

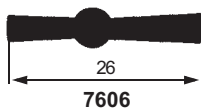
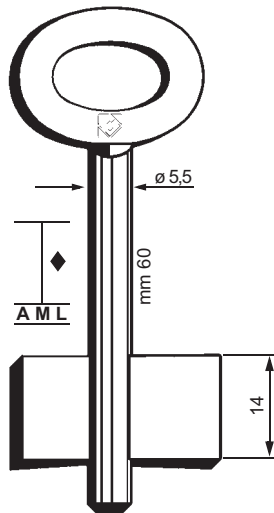

7606

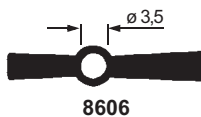

8606

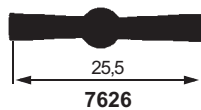
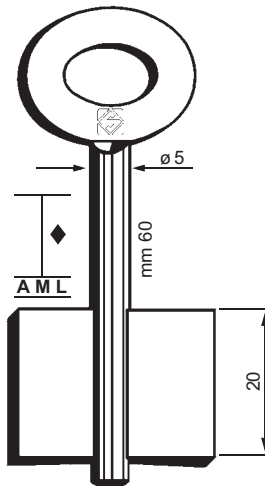

7626

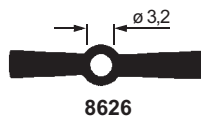

8626

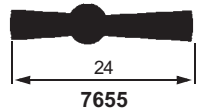
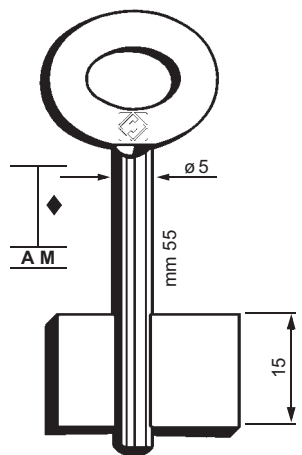

7655

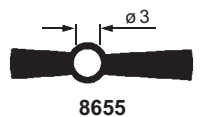

8655

PARMA

PARMA

FOR:
PER:

GB2

GERION

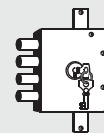

33

FOR/PER

GB2 (I)
GBZ

GBZ (I)
👁️ GB2 (33)

GERION (RUS)
+ 👁️ KERBEROS (39)

GIMAST (I)

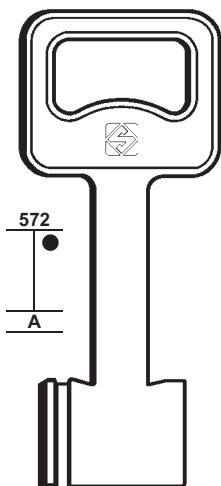

GBZ1

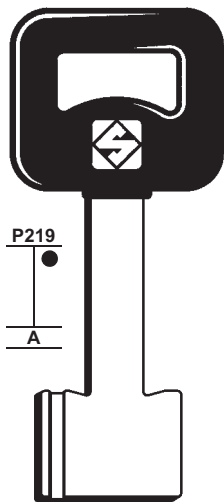

GBZ1P

GBZ

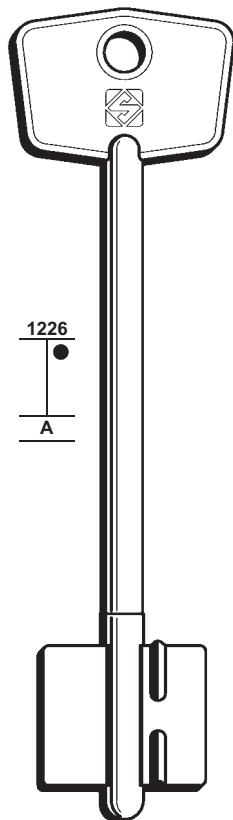

5CER4

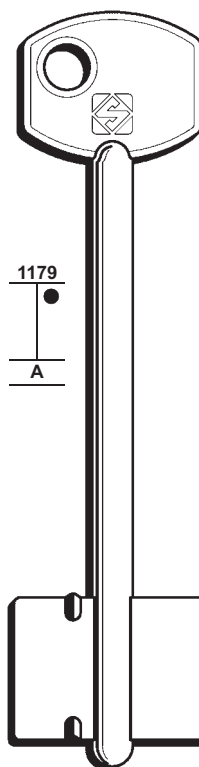

5CER9

FOR:
PER:

GERION

GIMAST

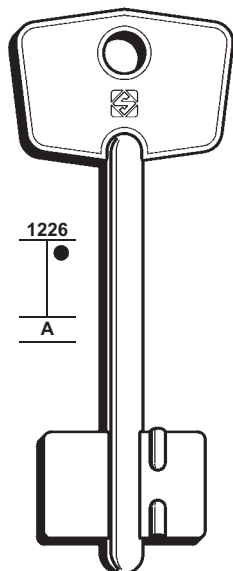

5CER12

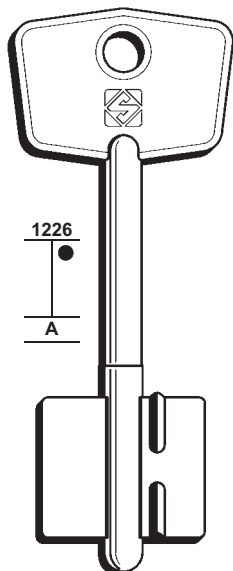

5CER2

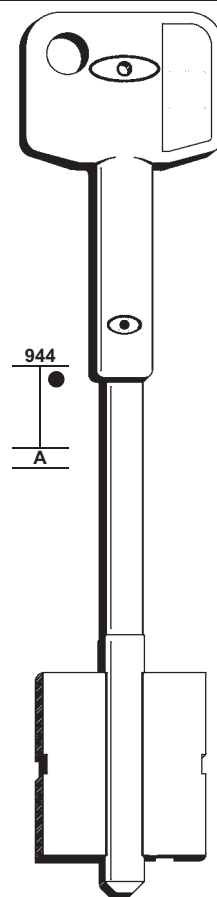

5GMA1T

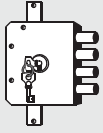

34

FOR/PER

GIPIS (I)
G.P.S.

GLITTENBERG (D)
👁️ (65)

GMG (I)

G.P.S. (I)
👁️ GIPIS (34)

GRODNO (RUS)
👁️ CORNI (16)

GUARDIAN (I)
👁️ FACEF (27)

HAGELIN (S)
👁️ (66)

HEERUM (D)

HK (CZ)

IDM (I)
FASEM
FIAM
VIRO

FOR:
PER:

GIPIS

GMG

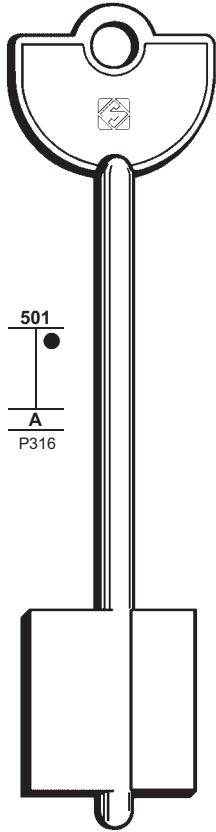

501
A
P316



GIL

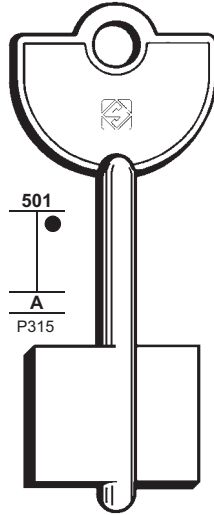

501
A
P315



GIC

G.P.S.

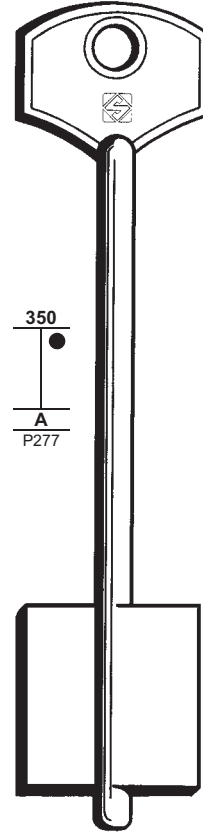

350
A
P277



GL

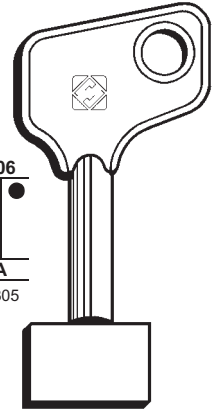

506
A
P305



GP



GPN

FOR:
PER:

HEERUM

HK

IDM

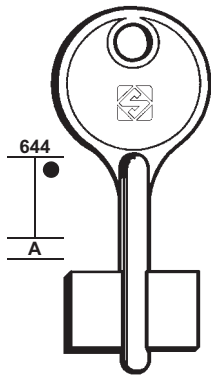

644
A



5HRM1

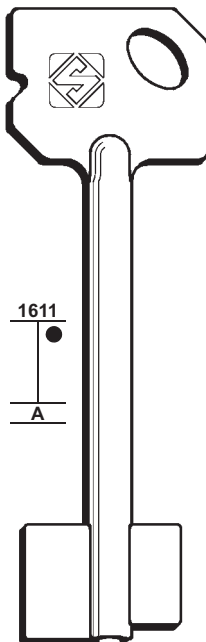

1611
A



5HK1

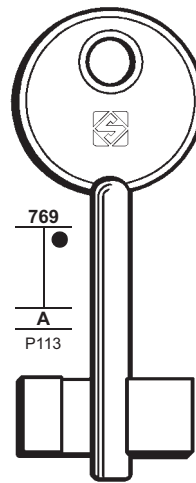

769
A
P113



5ID5

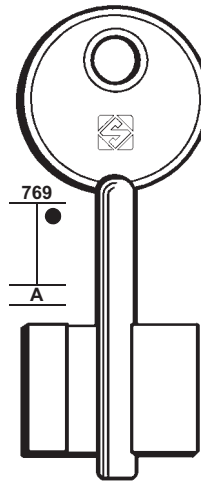

769
A



5ID7

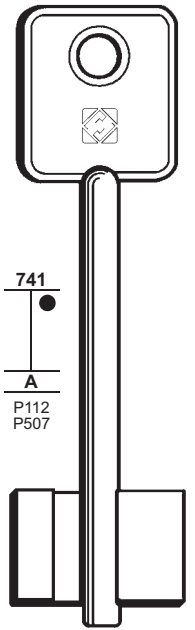

741
A
P112
P507



5ID3

FASEM - FIAM

FASEM

FASEM - FIAM
VIRO

FOR:
PER:

IDM

IMSI

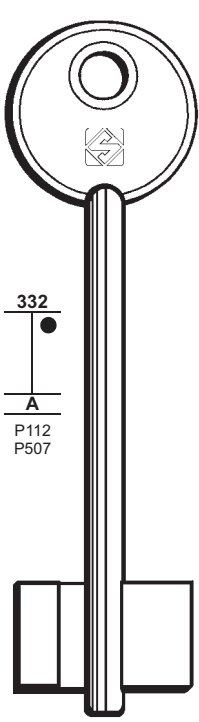

IDM

FASEM - VIRO

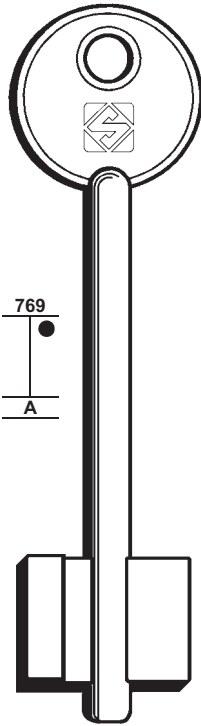

5ID9

FASEM

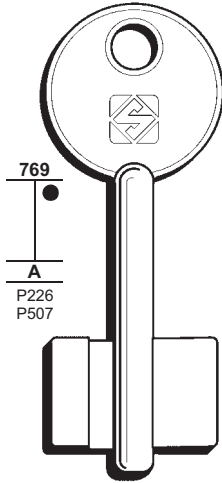

5ID11

FASEM - VIRO

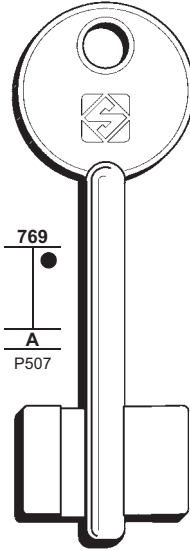

5ID13

FASEM - VIRO

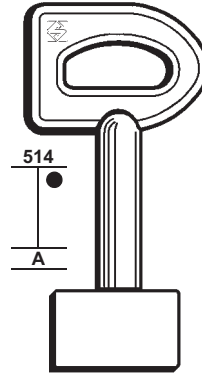

IPP

PATRONE

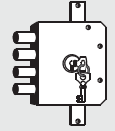

35

FOR/PER

IDM (1)
FASEM
VIRO

IMSI (1)
+ PATRONE

ISEO (1)
AUTORI

FOR:
PER:

ISEO

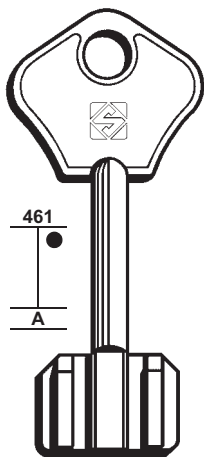

AUP

AUTORI

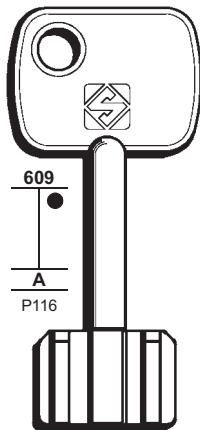

5IE5

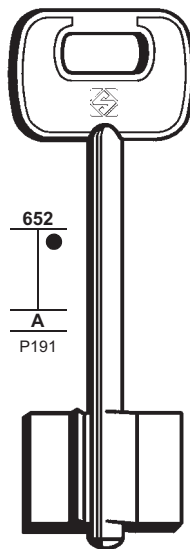

5IE7

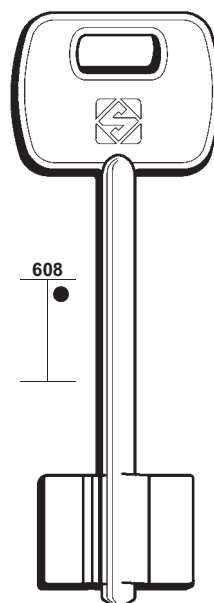

5IE11

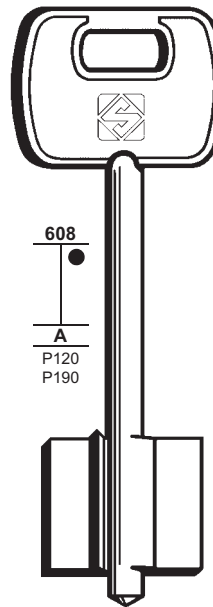

5IE9

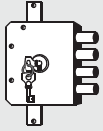

36

FOR/PER

ISEO (I)
AUTORI
MEGABLOCK

ISMET (I)
ESETY (25)

ITAL (I)

FOR:
PER:

ISEO

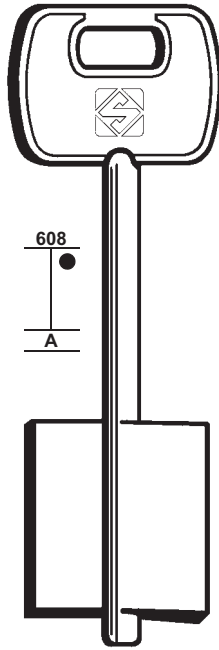

608
A



5IE1

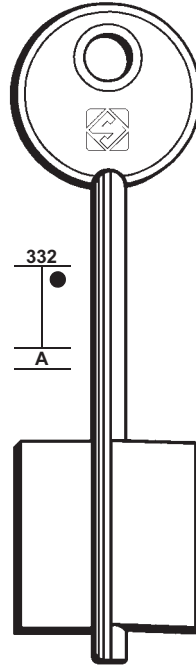

332
A



AUM
AUTORI

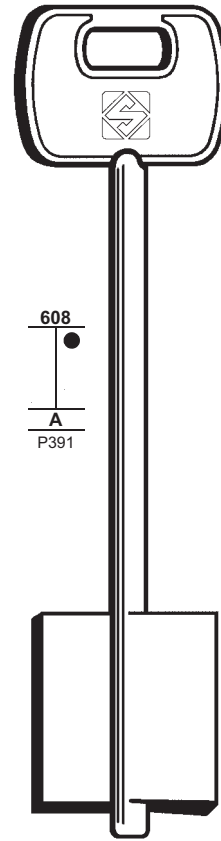

608
A
P391



5IE3
MEGABLOCK

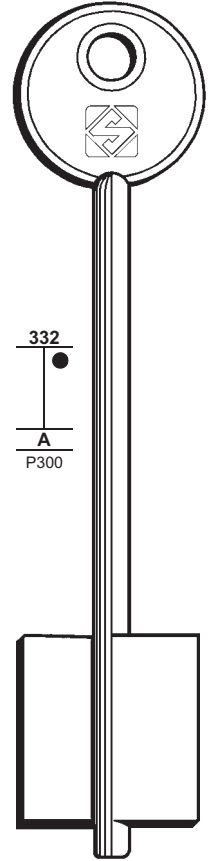

332
A
P300



AUL
AUTORI

FOR:
PER:

ITAL

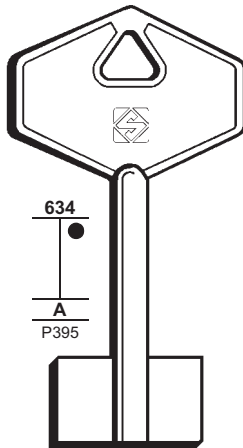

634
A
P395



5IT3

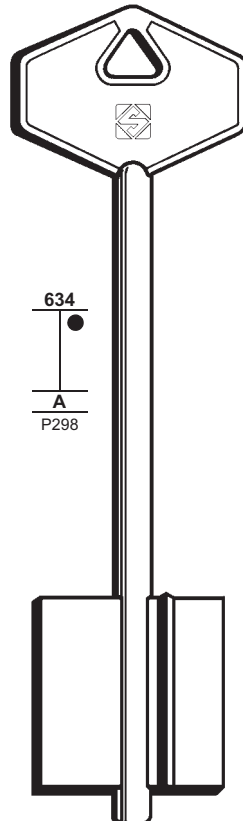

634
A
P298



5IT2

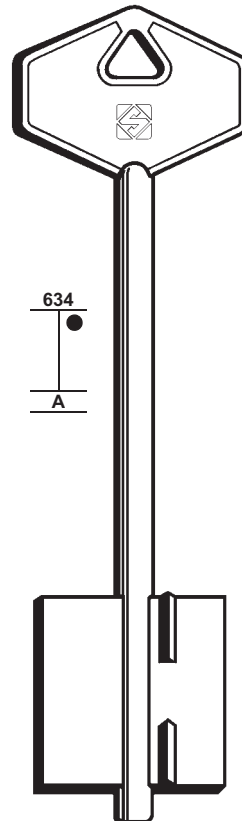

634
A



5IT6

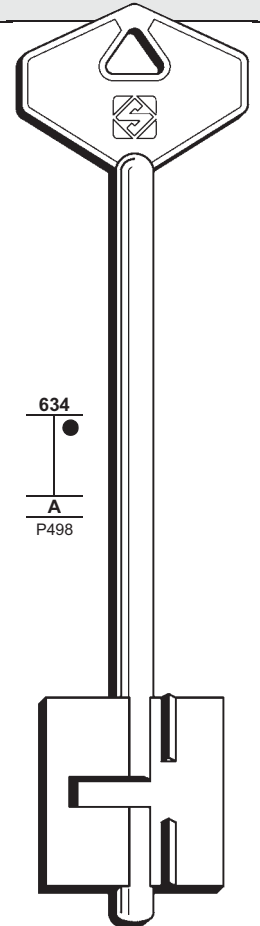

634
A
P498



5IT8

FOR:
PER:

JUWEL

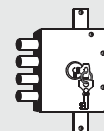

37

FOR/PER

JUWEL (I)
ASIAGHI
BURG-WÄCHTER

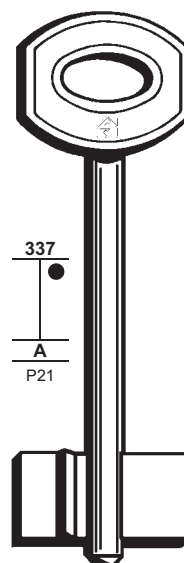
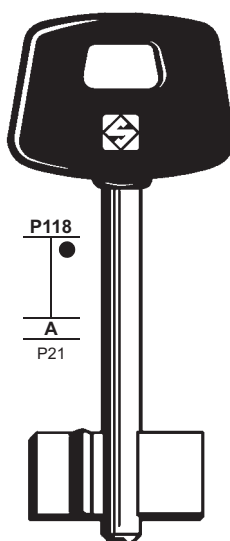
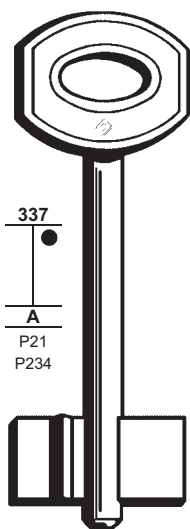
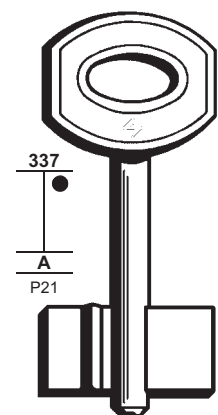

JW20



JW35



JW35P



JW40

BURG-WÄCHTER

BURG-WÄCHTER

FOR:
PER:

JUWEL

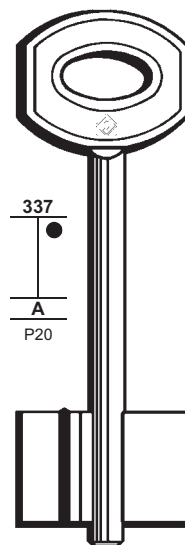
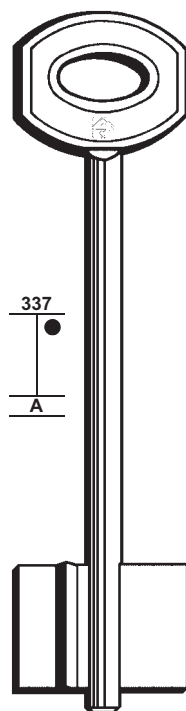
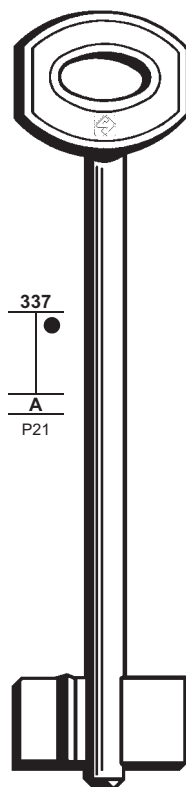
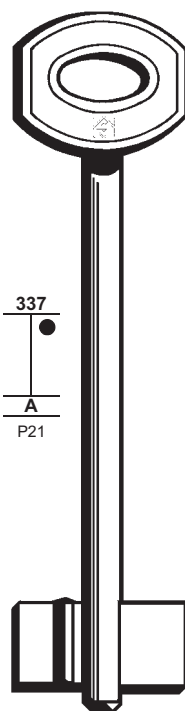
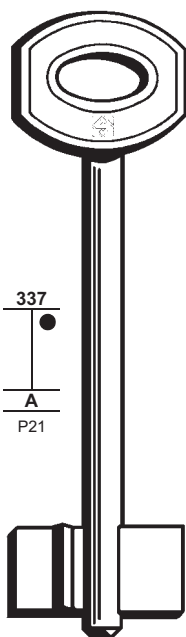

JW50



JW60



JW70



JW90



5JW1

ASIAGHI

BURG-WÄCHTER

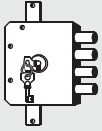

38

FOR/PER

KASSEL (I)
SERMEC
YALE

FOR:
PER:

KASSEL

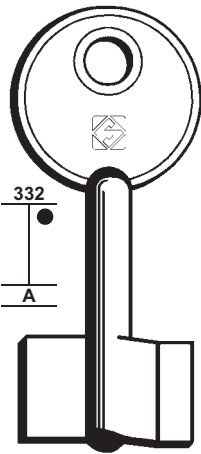

332
A



KYP

YALE

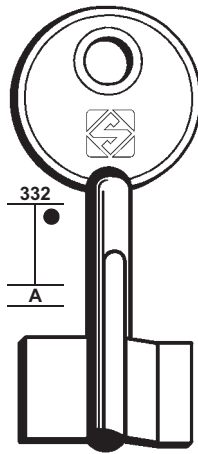

332
A



5KY2

YALE

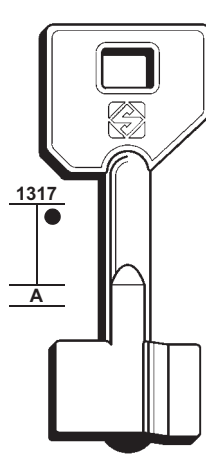

1317
A



5KY6

YALE

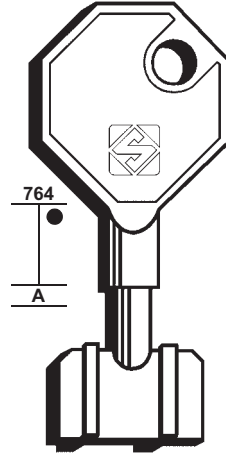

764
A



5K1

YALE

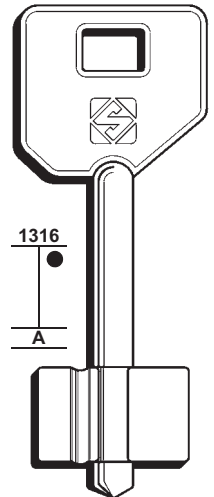

1316
A



5KY7

YALE

FOR:
PER:

KASSEL

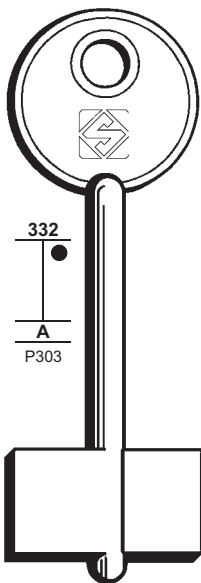

332
A
P303



5KY4
YALE

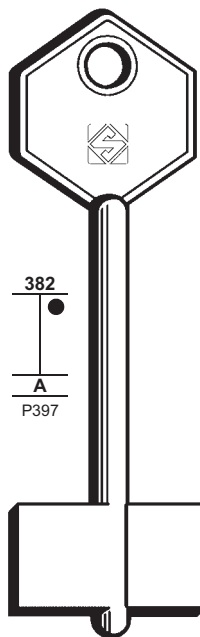

382
A
P397



YC
YALE

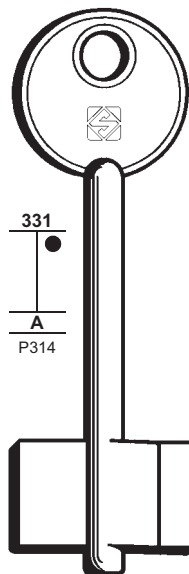

331
A
P314



KC

YALE

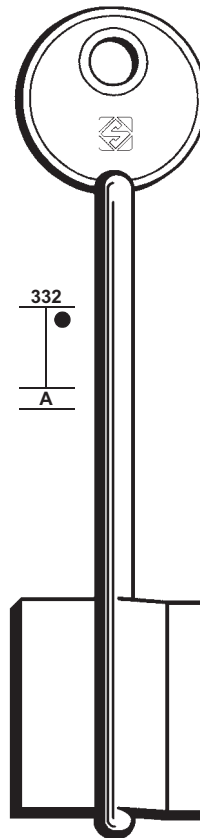

332
A



KYL
YALE

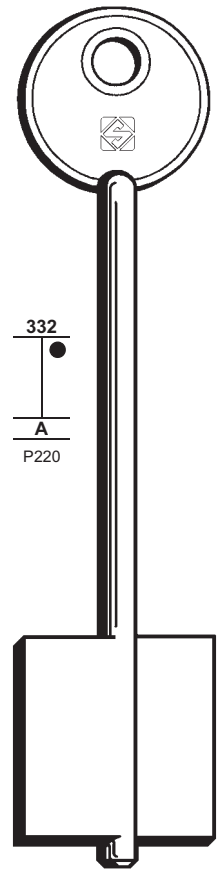

332
A
P220



KL
SERMEC - YALE

FOR:
PER:

KERBEROS

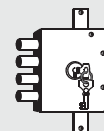

39

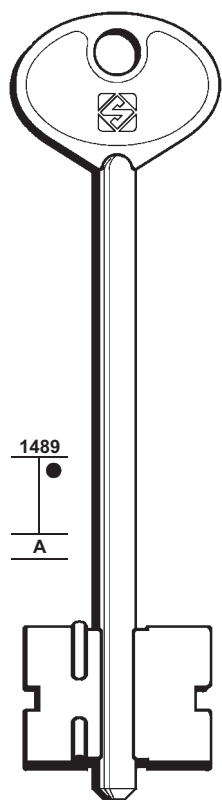

5KRB2

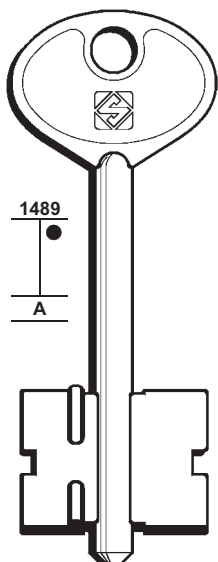

5KRB1

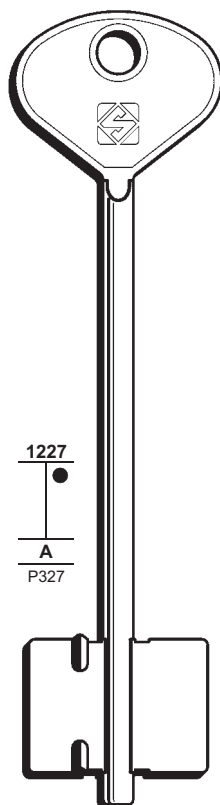

5CER7
GERION

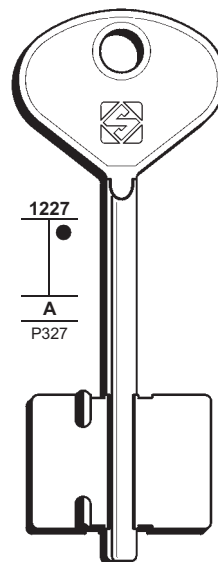

5CER5
GERION

FOR/PER

KERBEROS (RUS)
CERION

KIUSO (I)
EYE POTENT (49)

KREPICH (RUS)

KROMER (D)
EYE (67)

KURZEMES (RUS)

LINCE (E)
EYE CORNI (16)

LIPS-VAGO (I)
+ EYE (71)

FOR:
PER:

KREPICH

KURZEMES

LIPS-VAGO

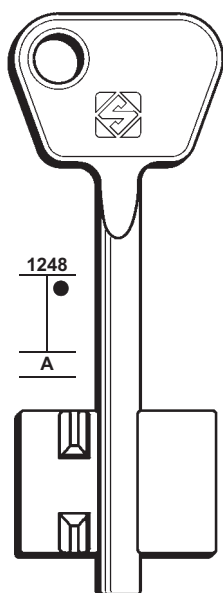

5KRC1

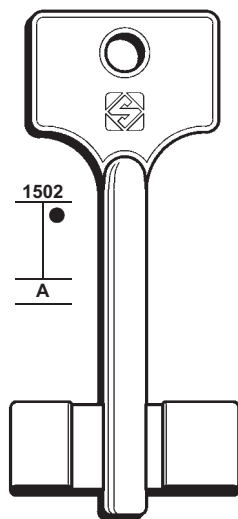

5KU1

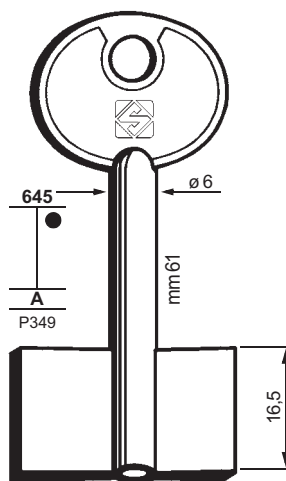

5LV1

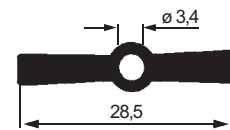

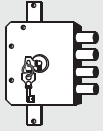

40

FOR/PER

LOWE & FLETCHER (GB)

MAUER (D)
DEKABA (19)

MAXIM (RUS)

MCM (E)
CISA (14)

MEGABLOCK (I)
ISEO (36)

MELSMETALL (D)
+ (66-73)

METTEM (RUS)

MERONI (I)
SECUREMME (53)

MIA (I)
SAFE (52)

FOR: PER: **LOWE & FLETCHER**

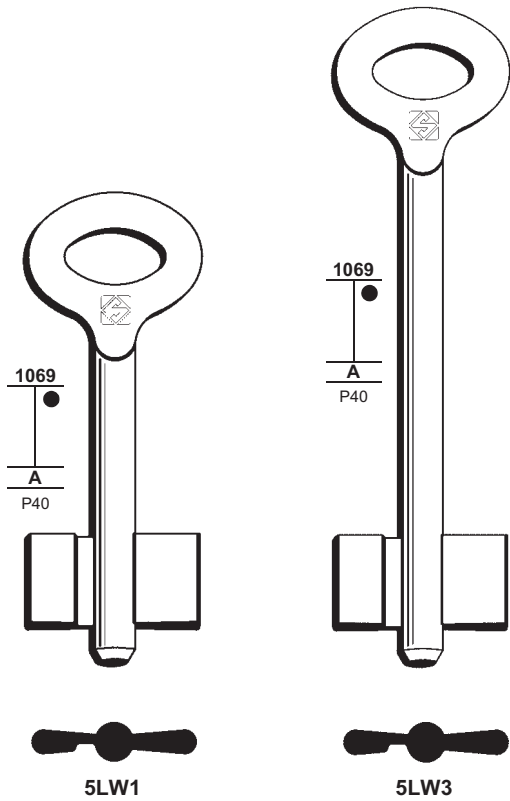

MAXIM

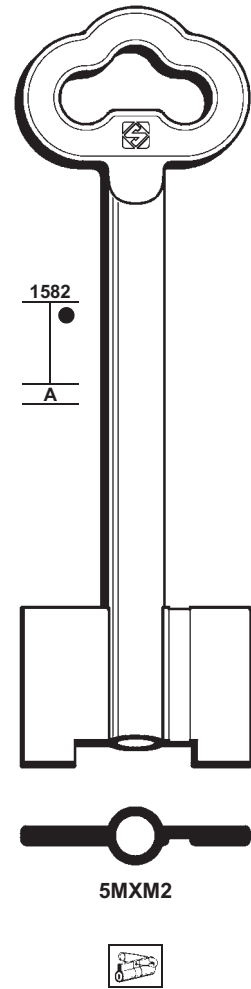

FOR: PER: **MELSMETALL**

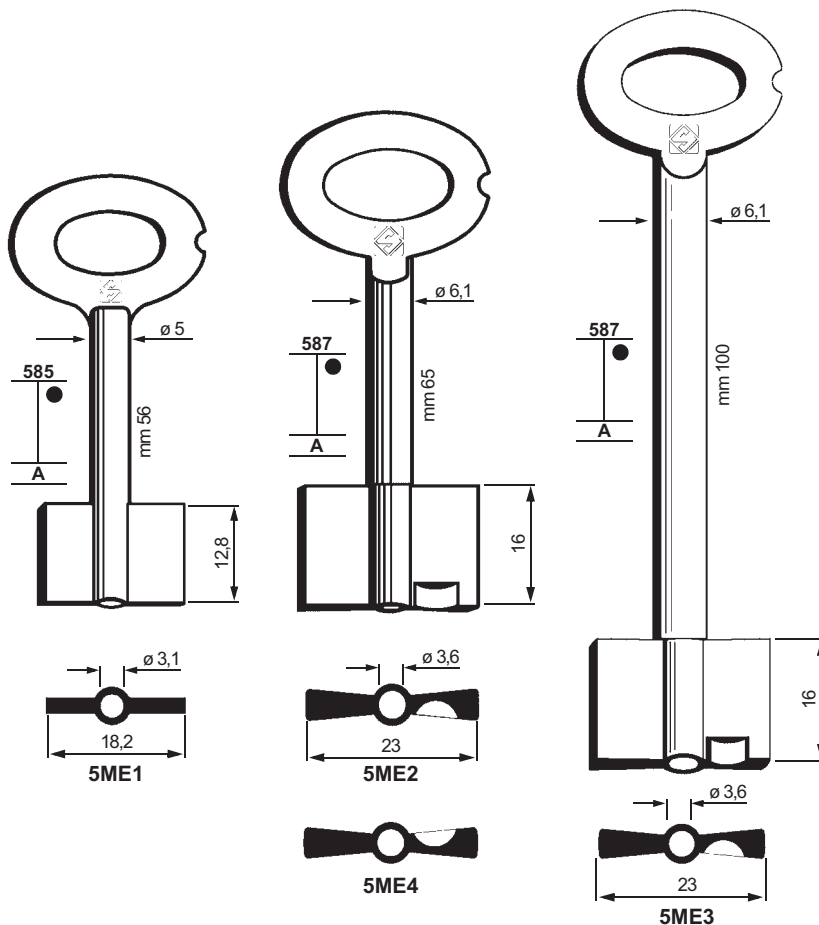

METTEM

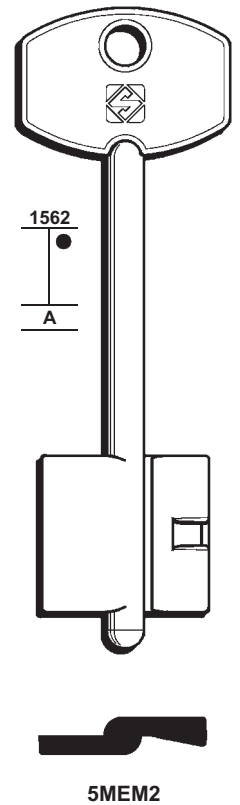

FOR: MOBELLA
PER:

MOIA

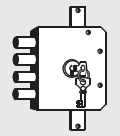

41

FOR/PER

MOBELLA (S)

MOIA (I)
OMR

MOTTURA (I)

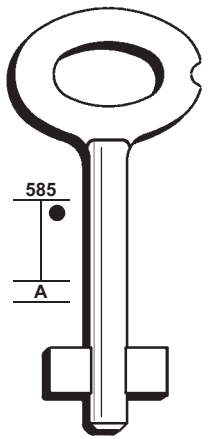

3FMB01

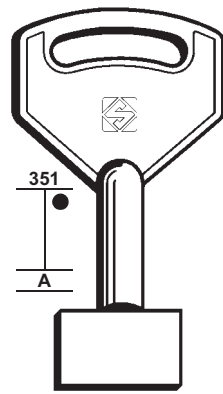

PP

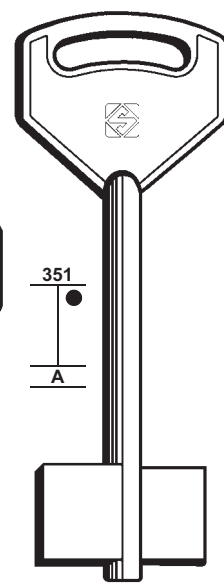

MC

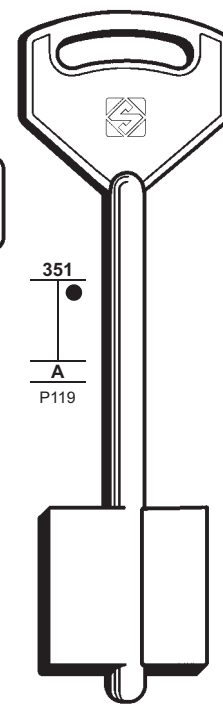

5MO2
OMR

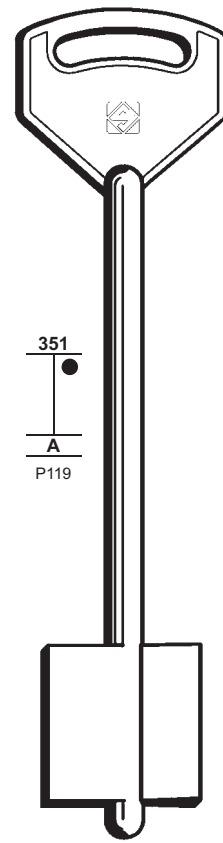

ML
OMR

FOR:
PER:

MOTTURA

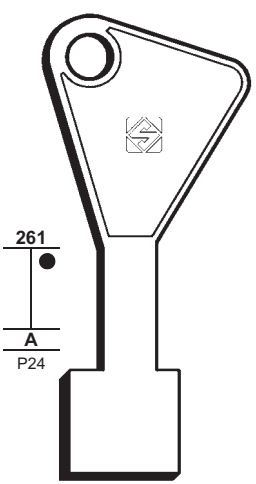

MT2
E

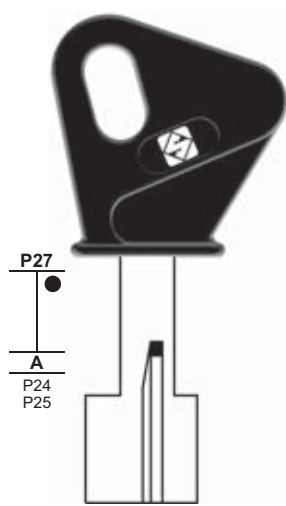

MT2P
E

MT2RP
H

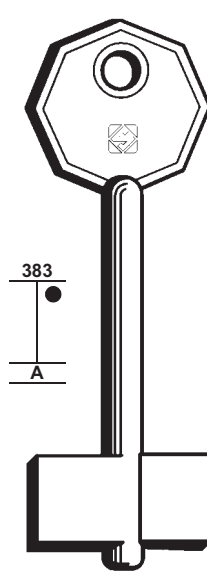

MT

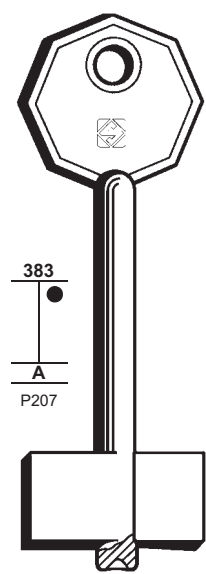

MTF



MT3
C



MT3P
C



MT3RP
F

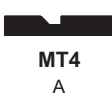

MT4
A



MT4P
A



MT4RP
G

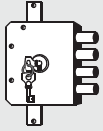

42

FOR/PER

MOTTURA (I)
FEDELI

FOR:

PER:

MOTTURA

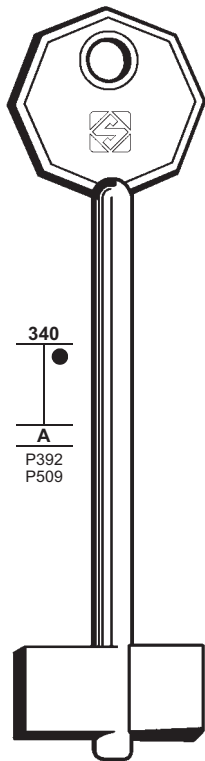

340
A
P392
P509



5MT12

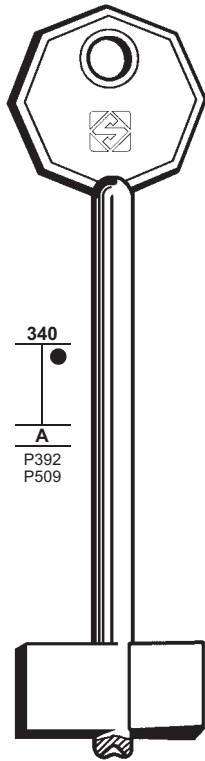

340
A
P392
P509



5MT12F

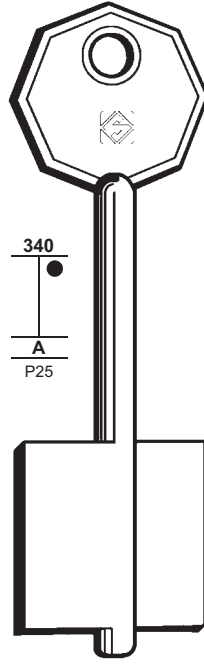

340
A
P25



MTM

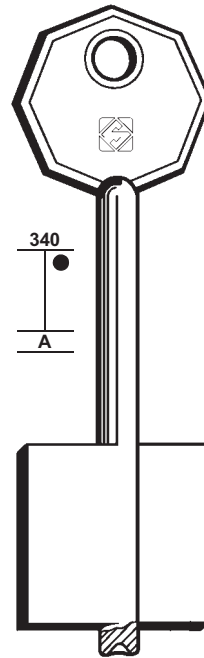

340
A



MTMF

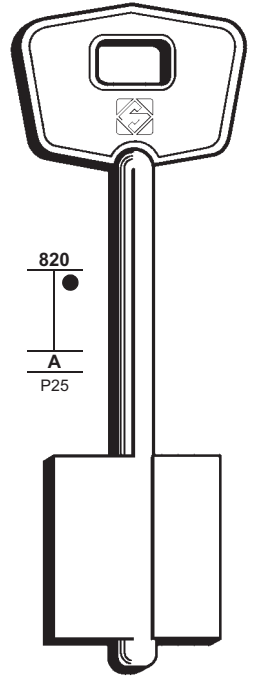

820
A
P25



5MT14

FOR:
PER:

MOTTURA

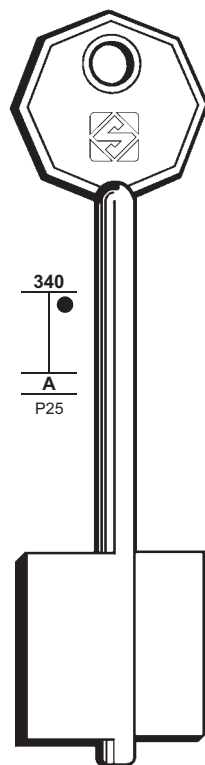

340
A
P25



5MT2

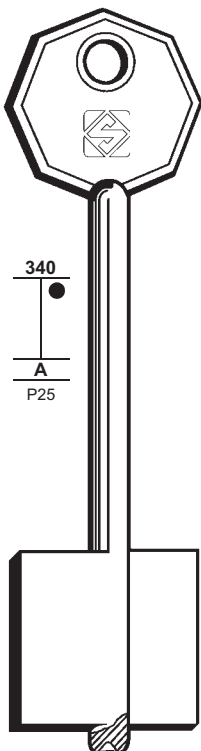

340
A
P25



5MT2F

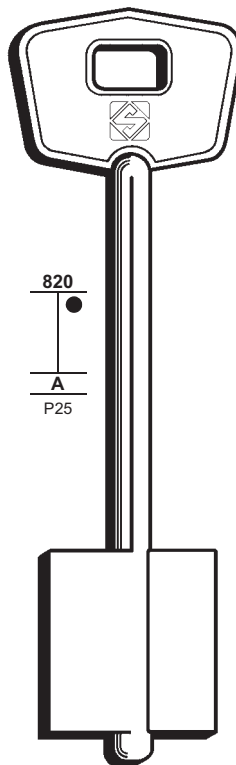

820
A
P25



5MT16

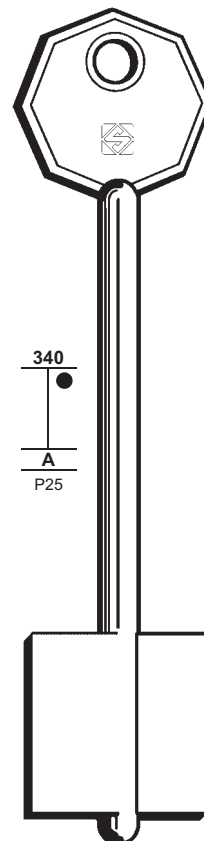

340
A
P25



MTL

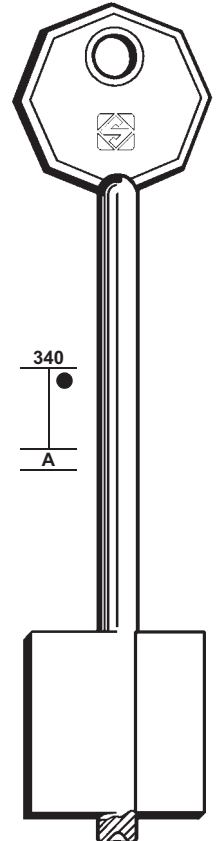

340
A



MTLF

FEDELI

FOR:
PER:

MOTTURA

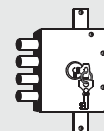

43

FOR/PER

MOTTURA (I)

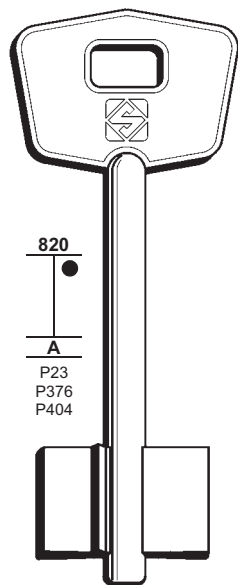

820

A

P23
P376
P404



5MT3

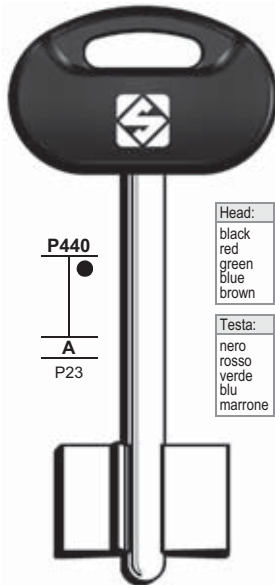

P440

A

P23

Head:
black
red
green
blue
brown

Testa:
nero
rosso
verde
blu
marrone



5MT3BP

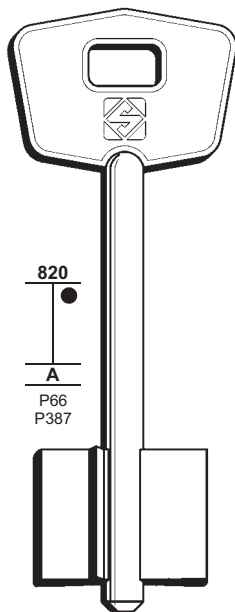

820

A

P66
P387



5MT7

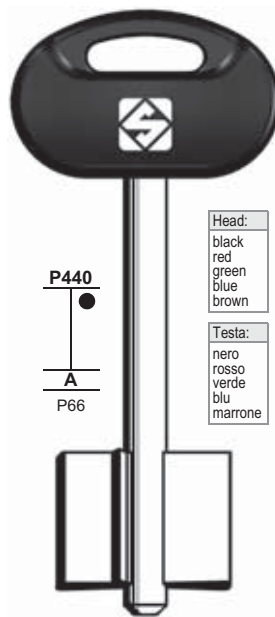

P440

A

P66

Head:
black
red
green
blue
brown

Testa:
nero
rosso
verde
blu
marrone



5MT7BP

FOR:
PER:

MOTTURA

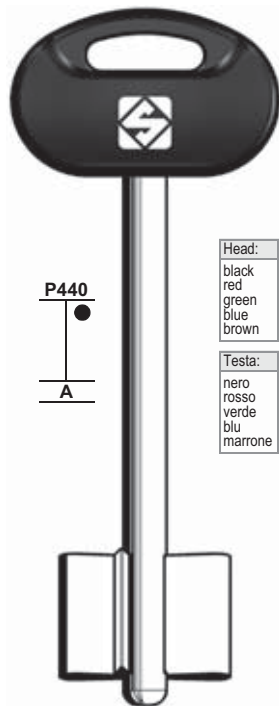

P440

A

Head:
black
red
green
blue
brown

Testa:
nero
rosso
verde
blu
marrone



5MT21BP

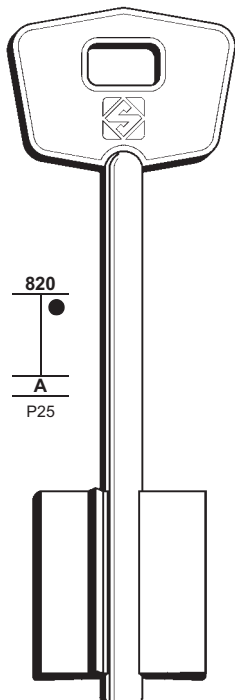

820

A

P25



5MT5

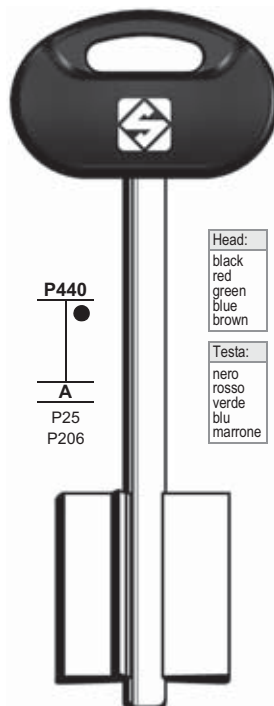

P440

A

P25
P206

Head:
black
red
green
blue
brown

Testa:
nero
rosso
verde
blu
marrone



5MT5BP

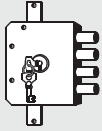

FOR:

PER:

MOTTURA

44

FOR/PER

MOTTURA (I)

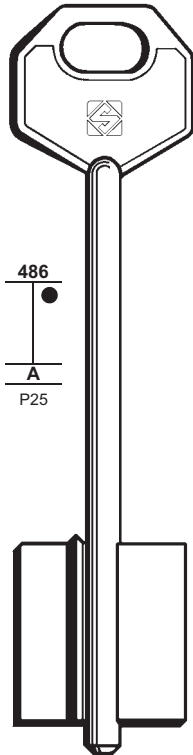

486
A
P25

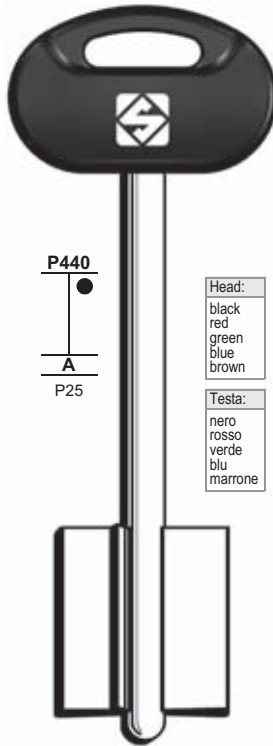

P440
A
P25

Head:
black
red
green
blue
brown

Testa:
nero
rosso
verde
blu
marrone

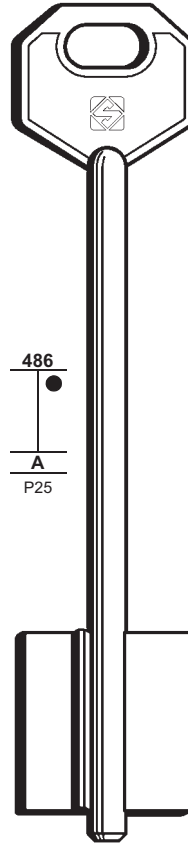

486
A
P25

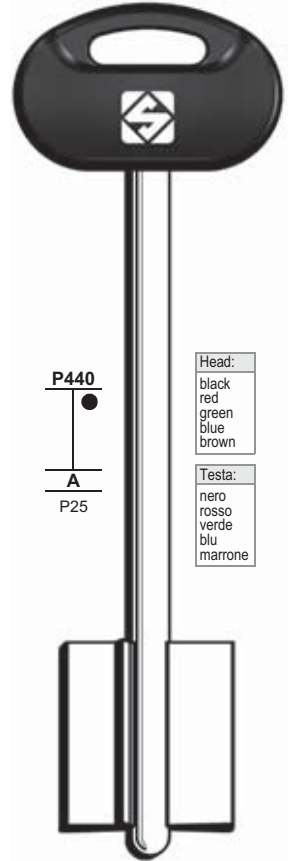

P440
A
P25

Head:
black
red
green
blue
brown

Testa:
nero
rosso
verde
blu
marrone



5MT9



5MT9BP



MTNC



MTNCBP



5MT10



5MT10BP



MTN



MTNBP

FOR:
PER:

MOTTURA

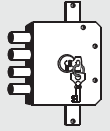

45

FOR/PER

MOTTURA (1)

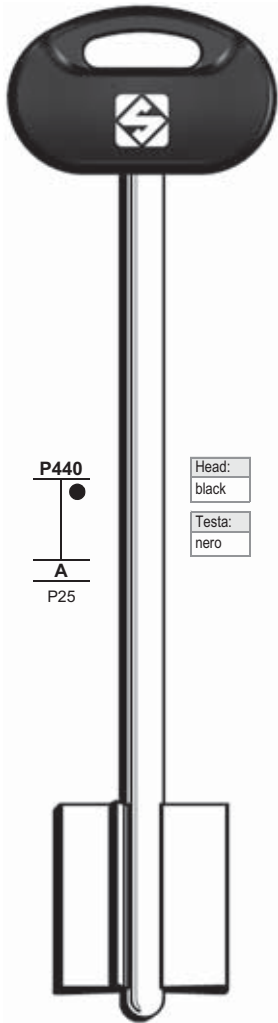

Head:
black
Testa:
nero



5MT19BP

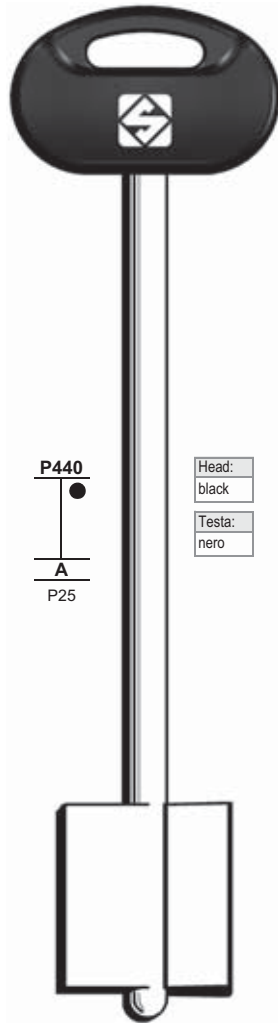

Head:
black
Testa:
nero



5MT18BP

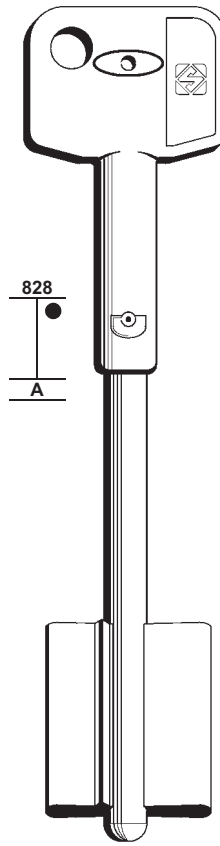

Head:
black
Testa:
nero



5MT26T



5MT23T

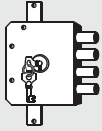

46

FOR/PER

MUEL (F)
VAK

FOR:
PER:

MUEL

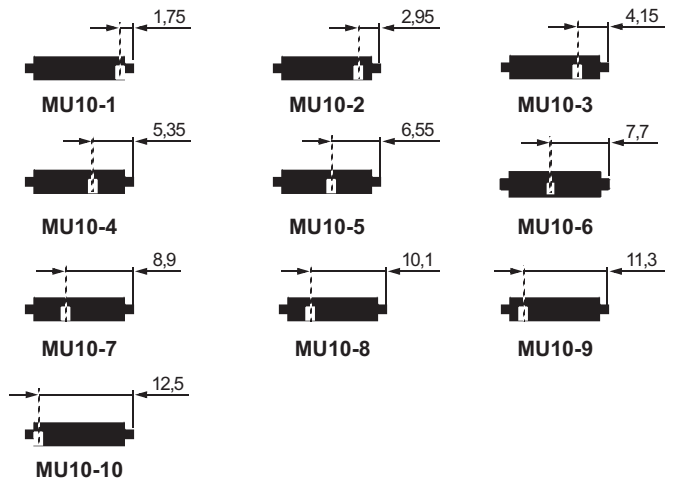
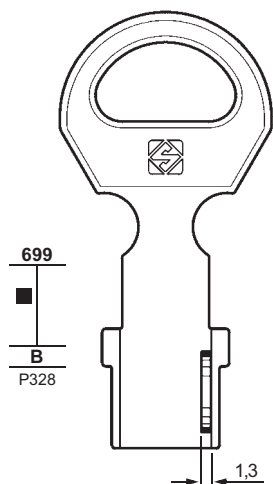
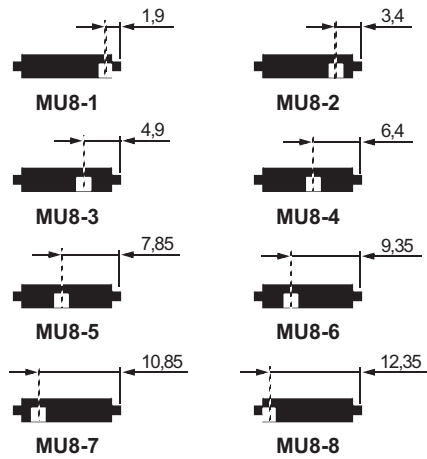
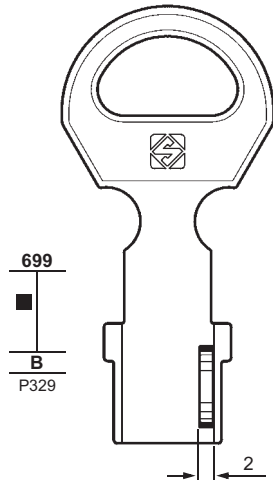
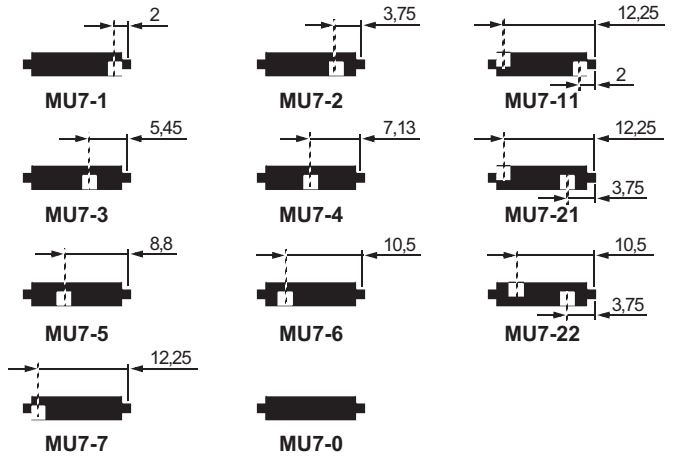
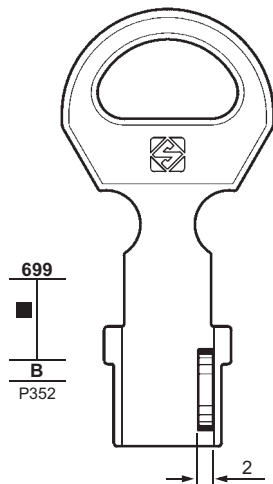
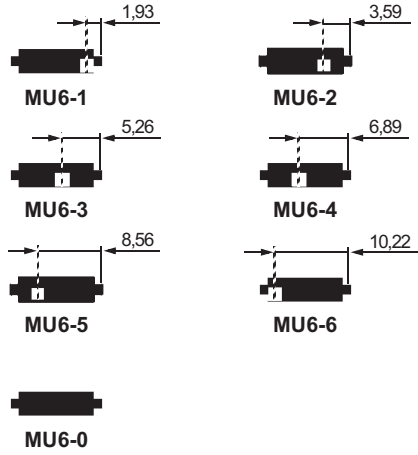
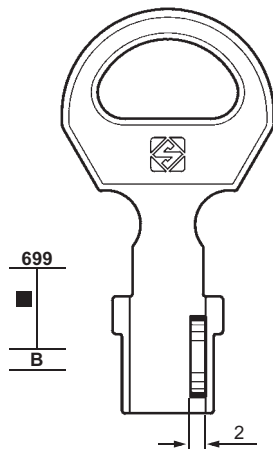

VAK

FOR:
PER:

OMEC

OSLA

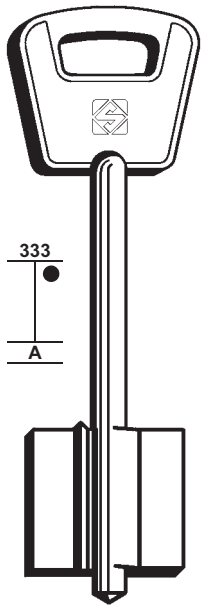

50C1

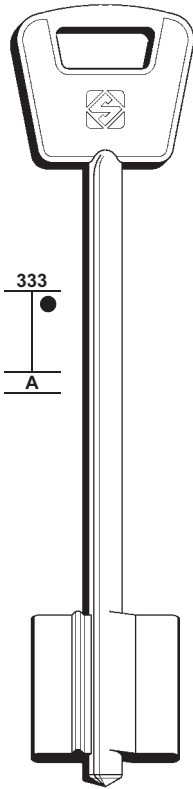

50C3

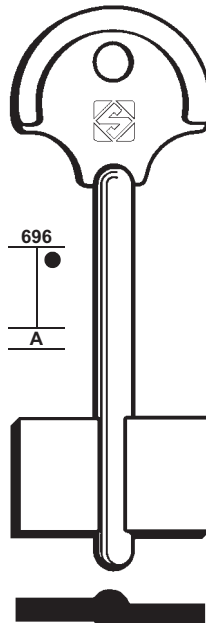

5OSL1

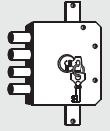

47

FOR/PER

OMEC (I)

OMR (I)

+ MOIA (41)

OSLA (I)

+ CERUTTI (11-12)

PARMA-PAS (I)

+ FUMEO (32)

+ (72-76-78)

FOR:
PER:

PARMA-PAS

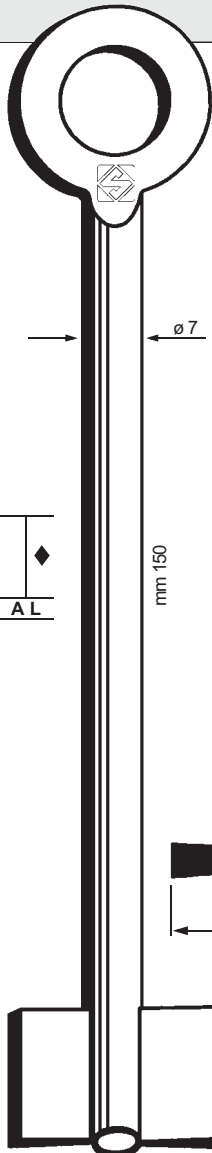

8615

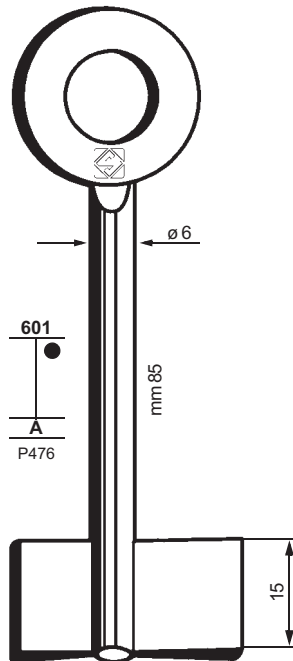

8385PA

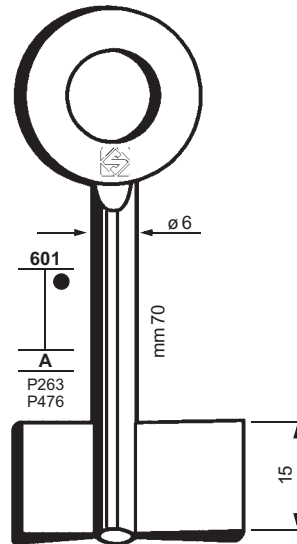

8370PA

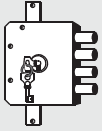

48

FOR/PER

PATRONE (I)
IMSI

PETTITI (I)

PREFER (I)
+ POTENT (48)

FOR:
PER:

PATRONE

PETTITI

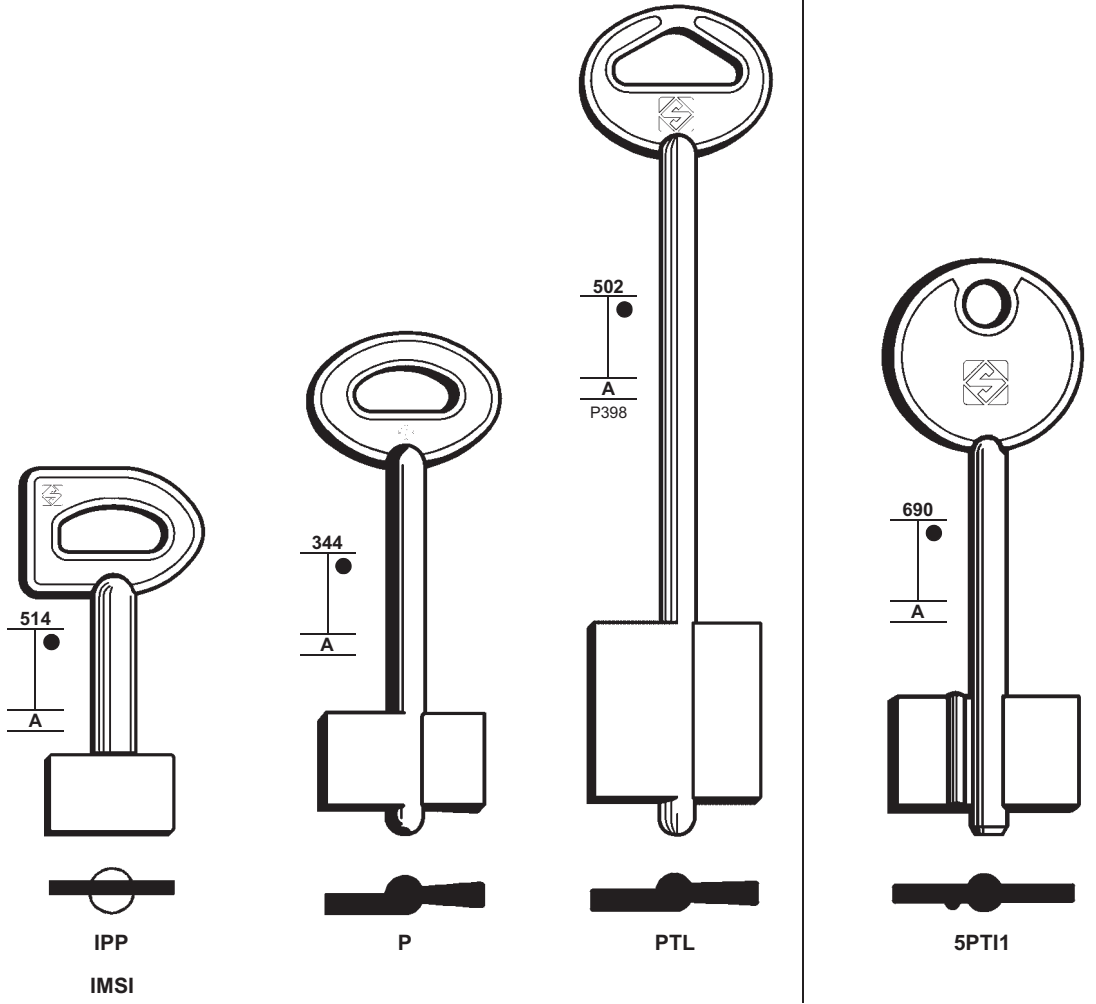

FOR:
PER:

POTENT

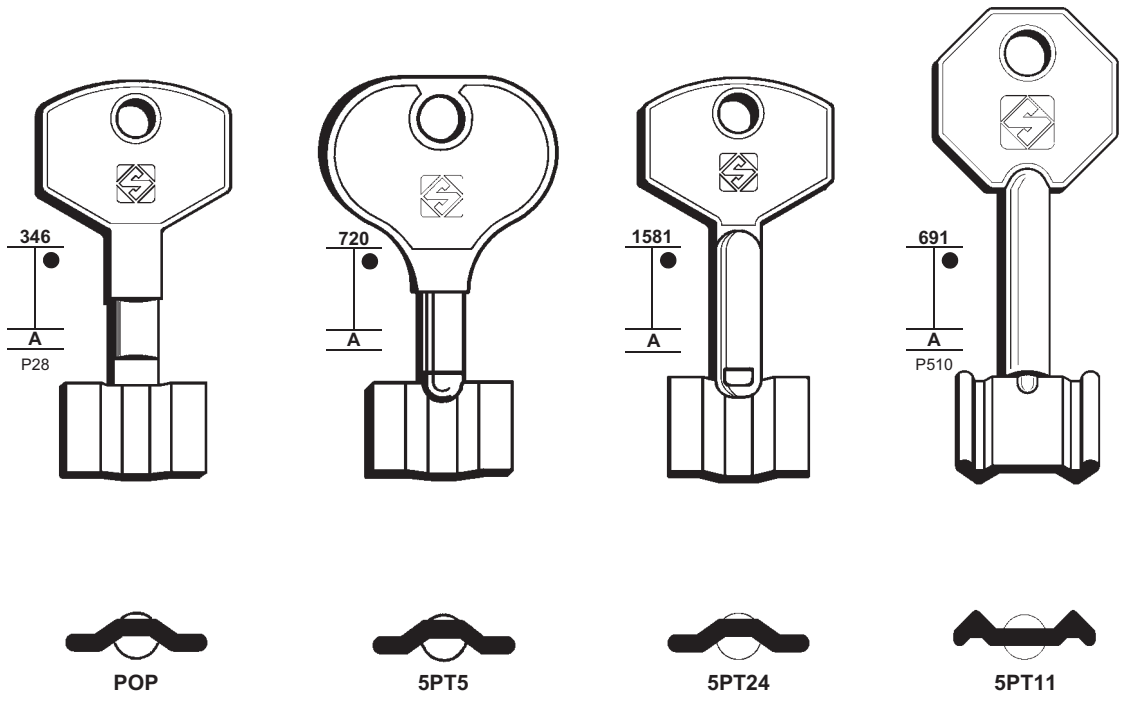

FOR:
PER:

POTENT

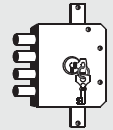

49

FOR/PER

POTENT (I)

ET
PREFER
VIRO

+ BETA (6)

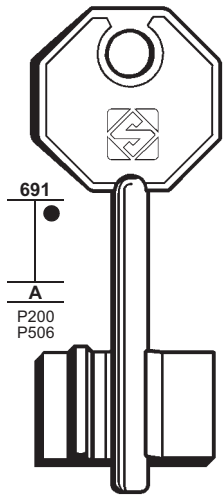

5PT3

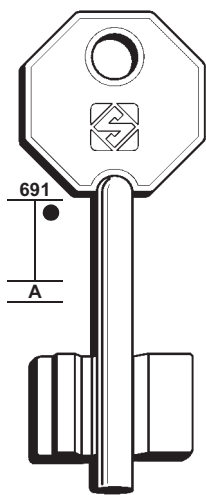

5PT13

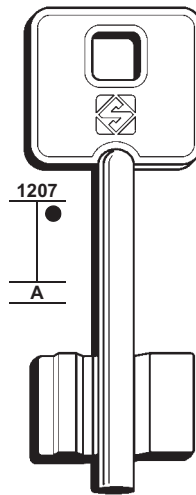

5PT21

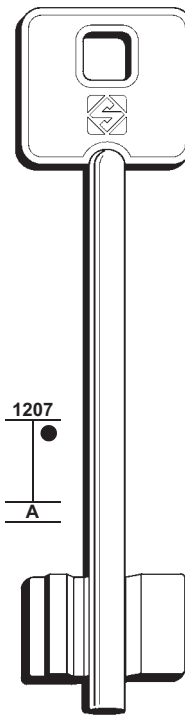

5PT15

ET - PREFER - VIRO

FOR:
PER:

POTENT

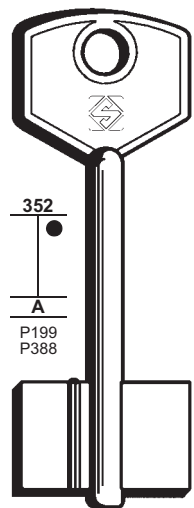

PO

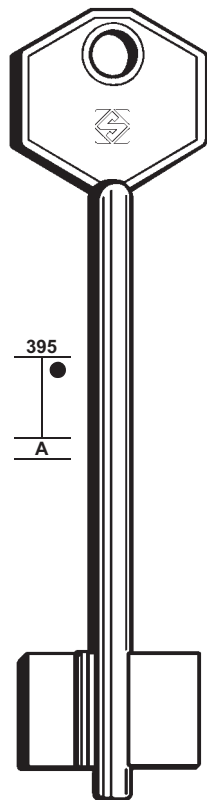

POL

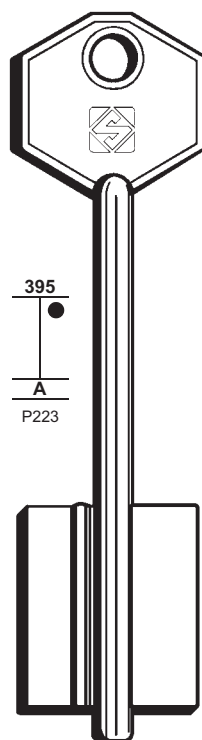

5PT1

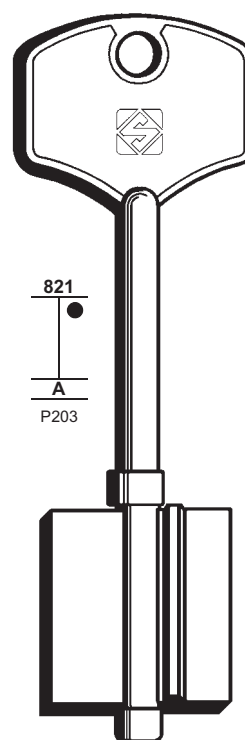

5PT2

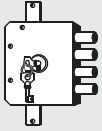

50

FOR/PER

POTENT (I)
KIUSO
VIPER
+ BETA (6)

FOR:
PER:

POTENT

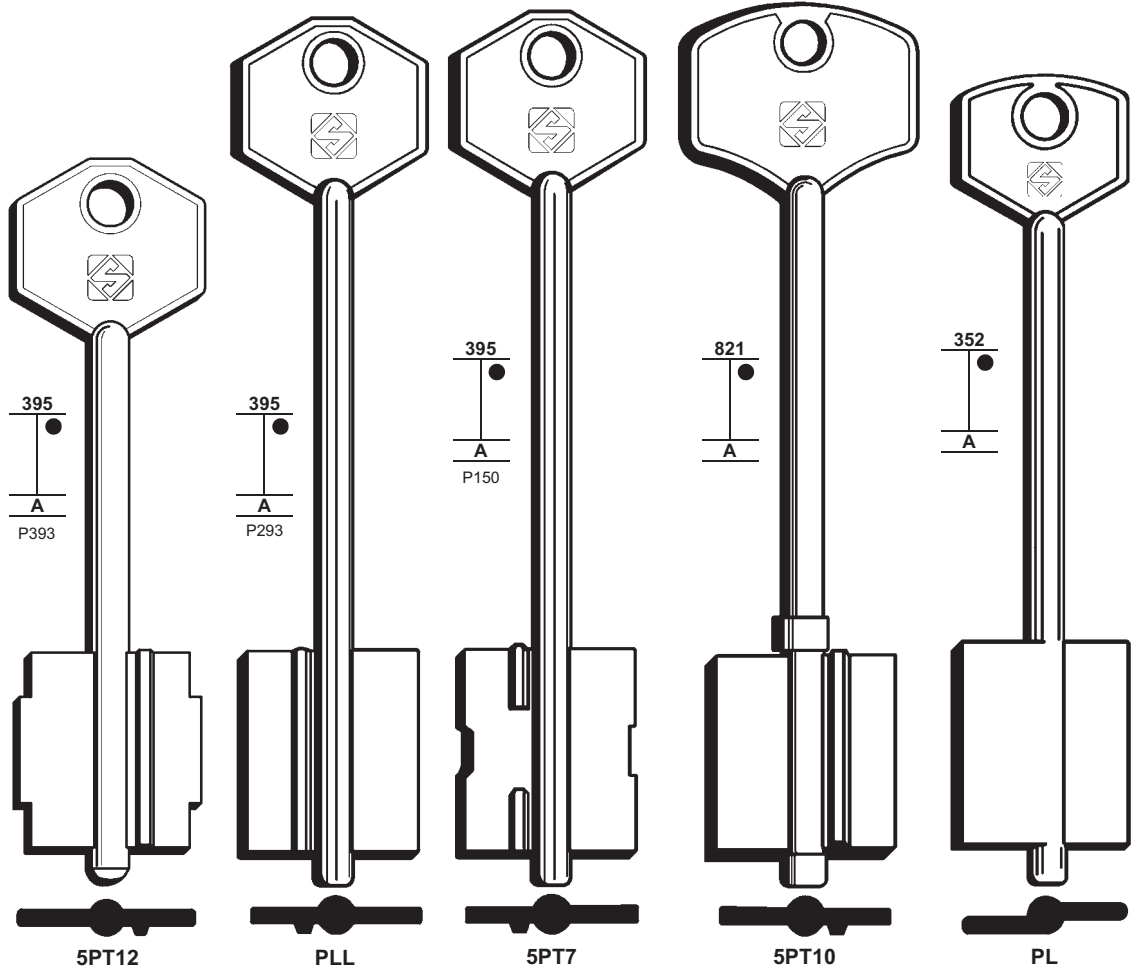

KIUSO - VIPER

FOR:
PER:

POTENT

PREFER

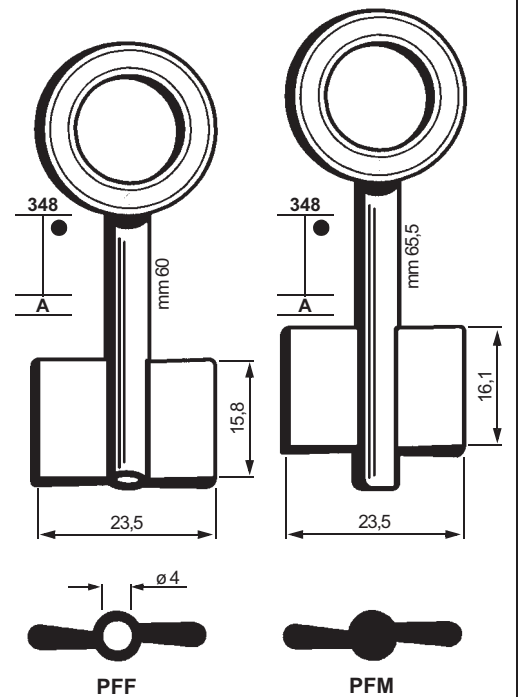
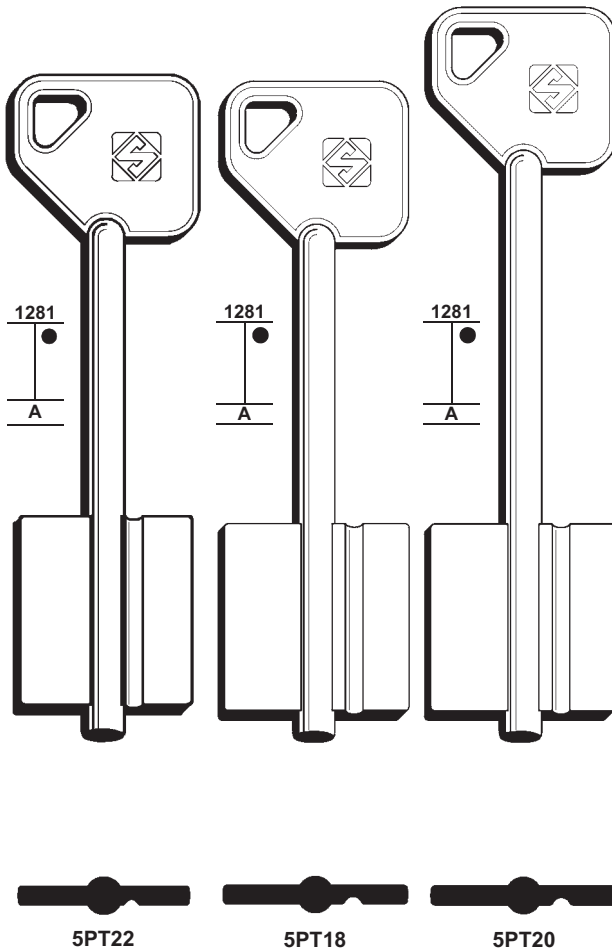

FOR:
PER:

PREFER

R.G.

ROLEX

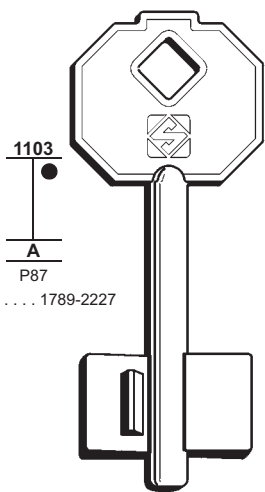

P87
... 1789-2227



5PF1

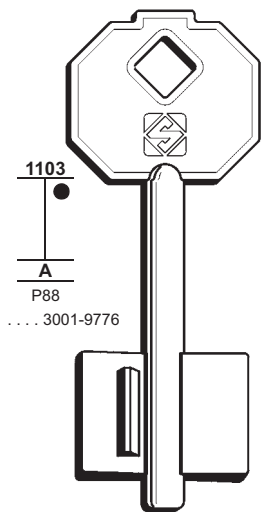

P88
... 3001-9776



5PF3

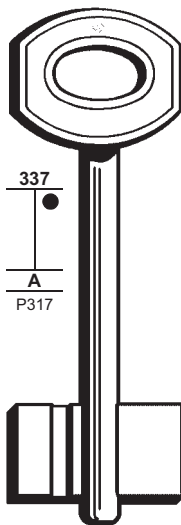

P317



RGC

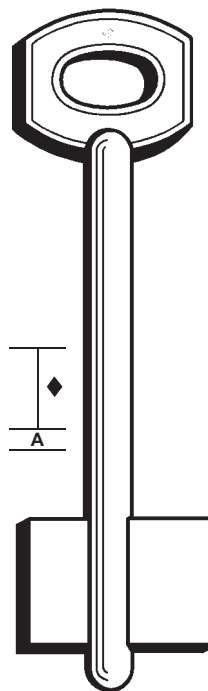

A



8384R

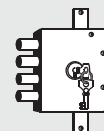

51

FOR/PER

POTENT (I)
+ BETA (6)

4TR (I)
+ (59)

R.G. (I)
(RAINONI G.)

ROLEX (GR)
+ (73)

ROSENGREN (S)
+ (71)

RUSSIA (RUS)

FOR:
PER:

ROSENGREN

RUSSIA

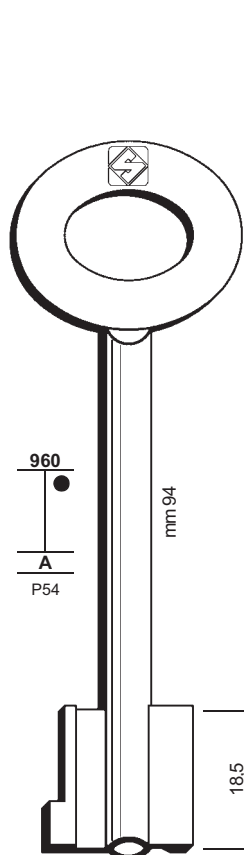

P54

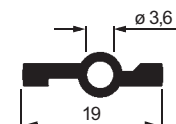

5RSG2

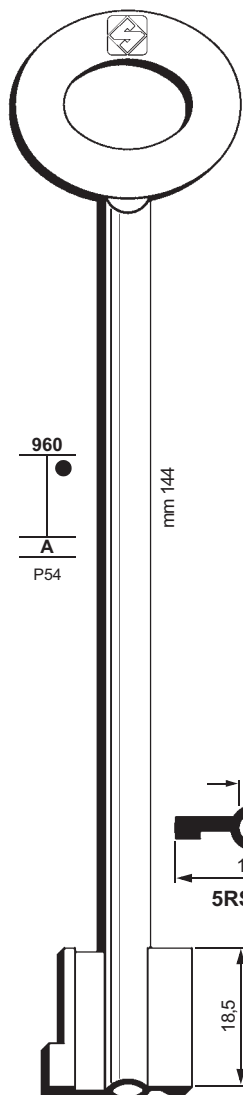

P54

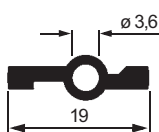

5RSG1

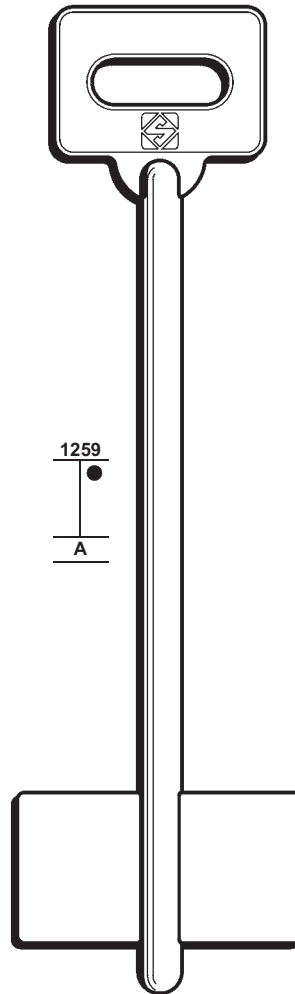

1259
A



5RUS1

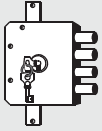

52

FOR/PER

SAB (I)
+ SECUREMME (53)

SAFE (I)
MIA
SETEC

SEA (I)

SECURCASA (I)
 (72)

SECURITAS (I)
 (65)

FOR:
PER:

SAB

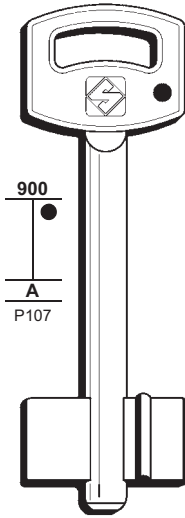

5SAB2

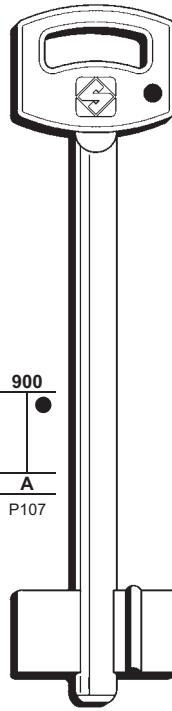

5SAB4

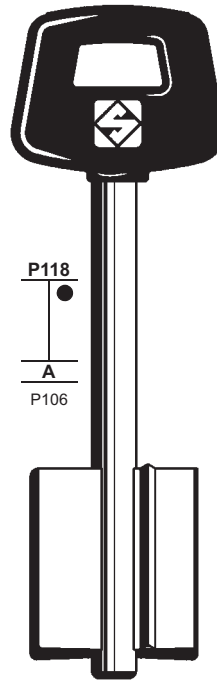

5SAB6P

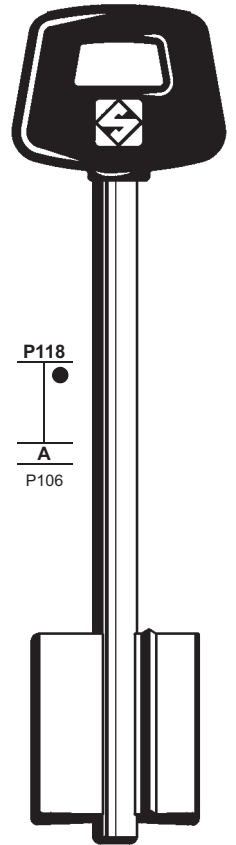

5SAB8P



FOR:
PER:

SAFE

SEA

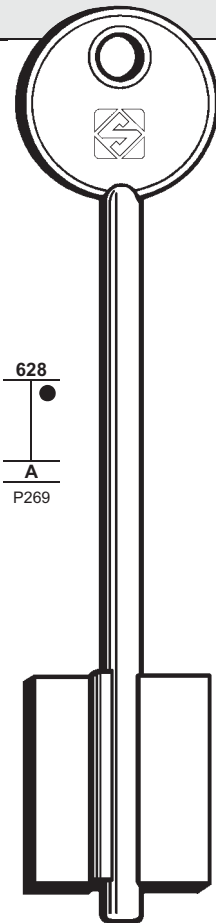

5MS1

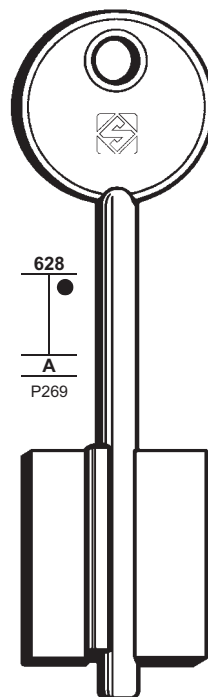

5MS3

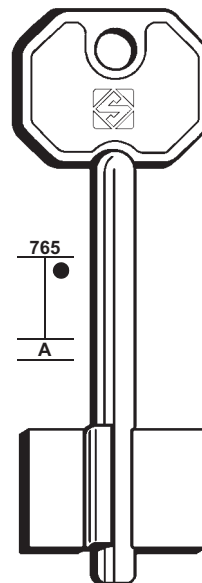

5MS5

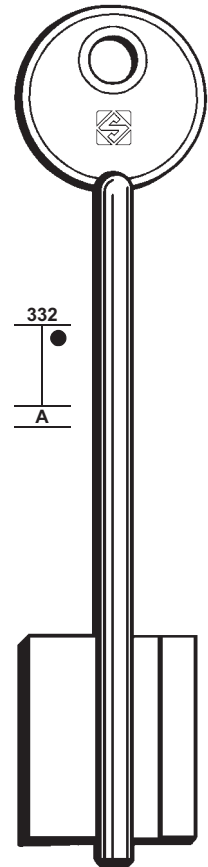

SE



MIA - SETEC

FOR:
PER:

SECUREMME

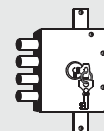

53

FOR/PER

SECUREMME (I)

CORNI
EMME
MERONI
SAB
SIBI
TO
TROLESE

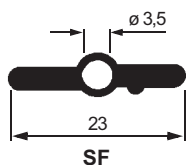
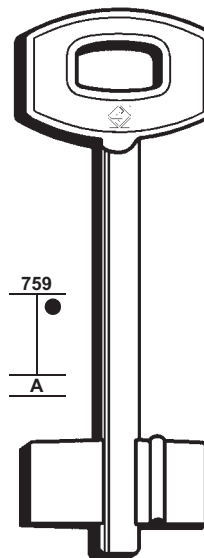
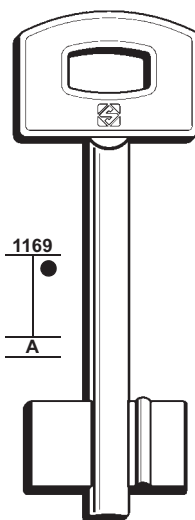
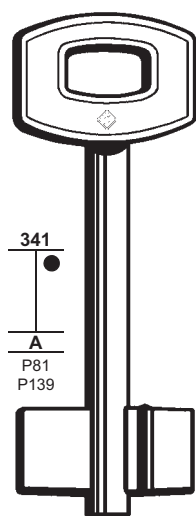
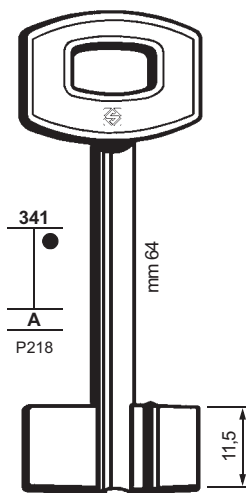

CORNI - EMME - MERONI - SAB - SIBI - TO - TROLESE

FOR:
PER:

SECUREMME

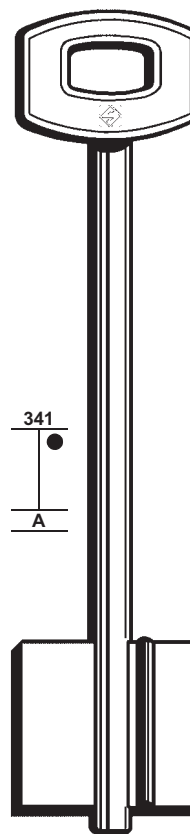
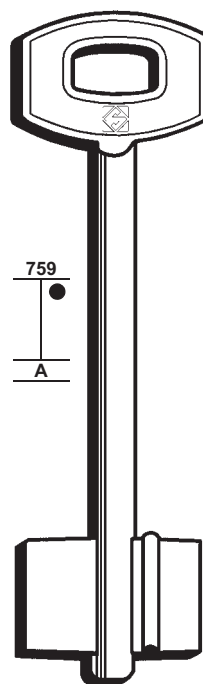
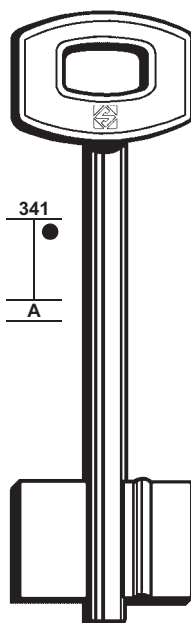
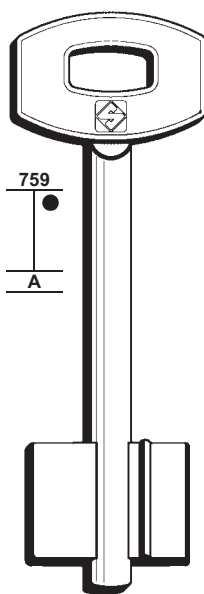
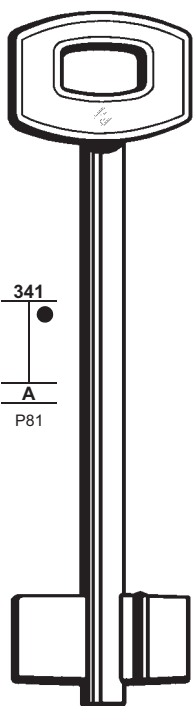

EMME - SAB - SIBI

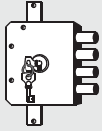

54

FOR/PER

SECUREMME (I)
SIBI

SELLA & VALZ (I)
+ (69)

FOR:
PER:

SECUREMME

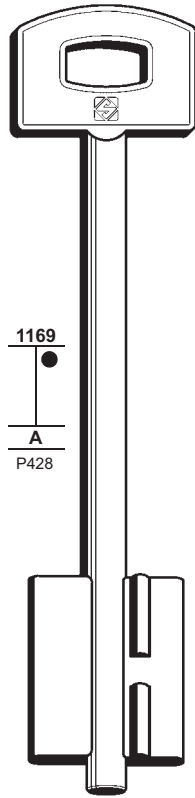

5SCM12

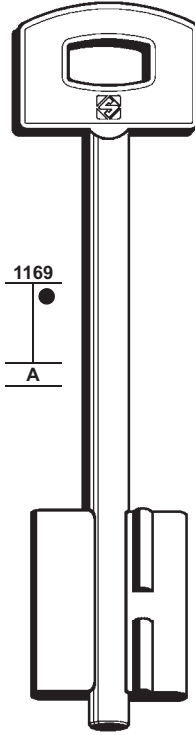

5SCM14

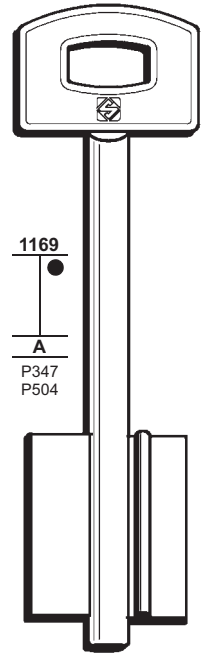

5SCM8

FOR:
PER:

SECUREMME

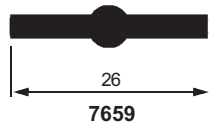
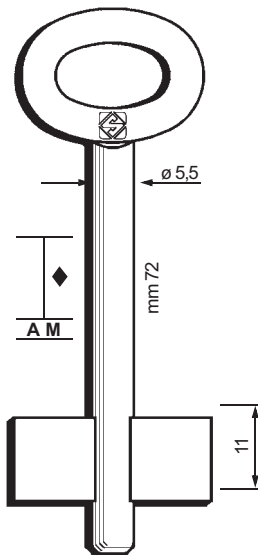

7659

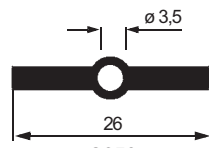
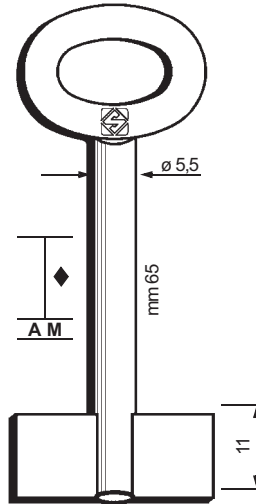

8659

SIBI

SELLA & VALZ

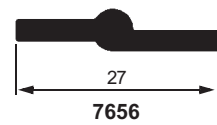
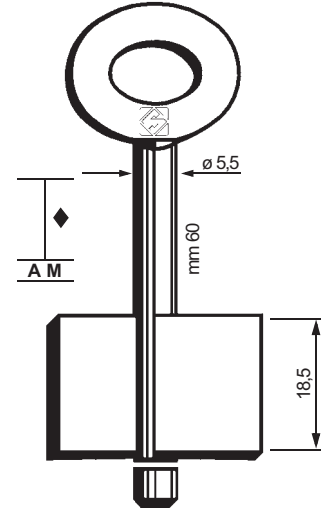

7656



8656

FOR:
PER:

SELLA & VALZ

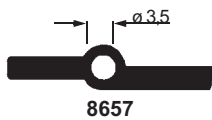
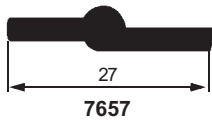
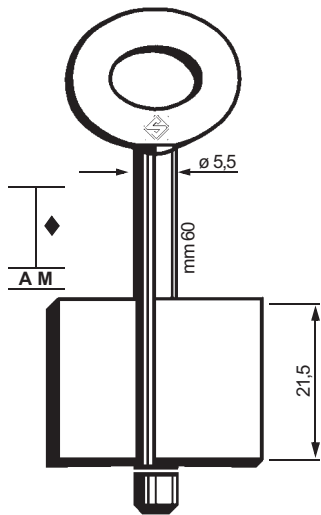

SERCAP

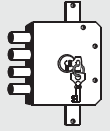
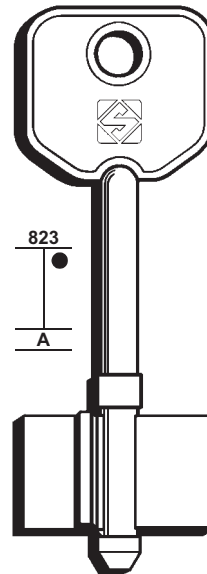
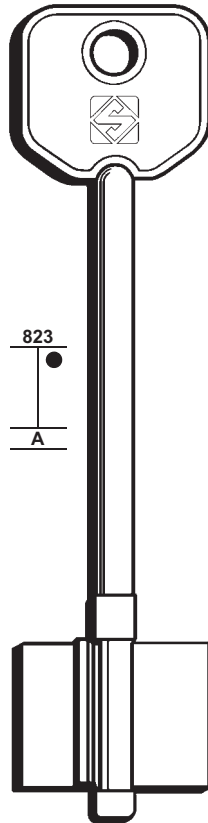

55

FOR/PER

SELLA & VALZ (I)
+ (68)

SERCAP (I)

SERMEC (I)
+ KASSEL (38)

FOR:
PER:

SERMEC

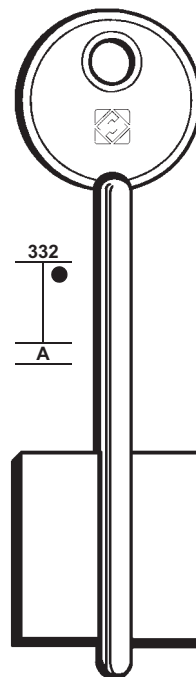
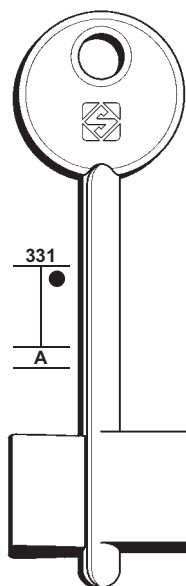
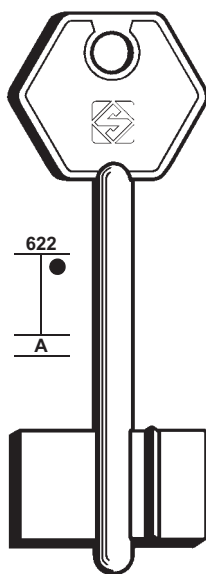
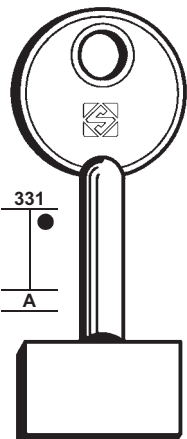

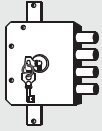

56

FOR/PER

SERMEC (I)
KASSEL
YALE
+ KASSEL (38)

SETEC (I)
 SAFE (52)

SIAS (I)

SIBI (I)
 SECUREMME (53-54)
+ (70)

SIDERAL (I)
CONFORTI

FOR:
PER: **SERMEC**

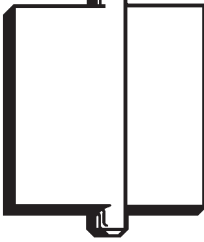
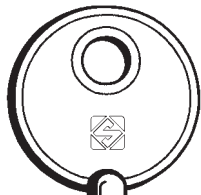

KL

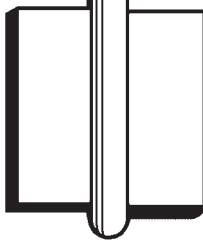
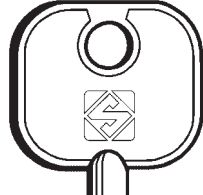

5SR2

KASSEL - YALE

SIAS

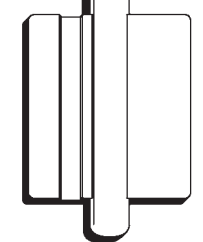
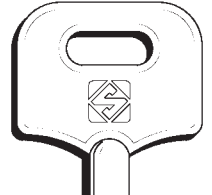

5SAS5

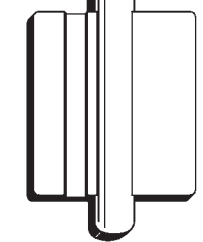
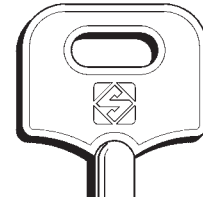

5SAS3

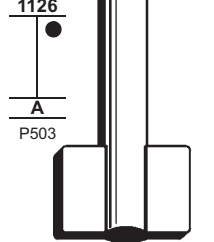

5SAS1

FOR:
PER:

SIDERAL

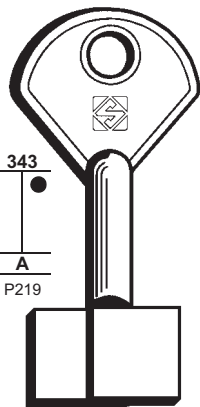

SDP

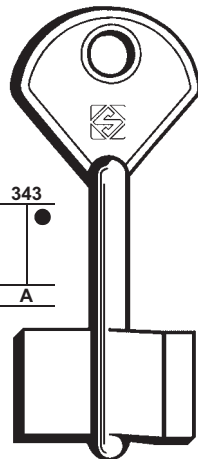

SDC

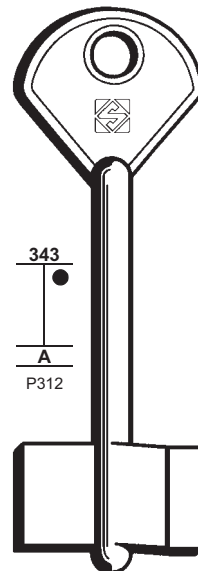

SDL

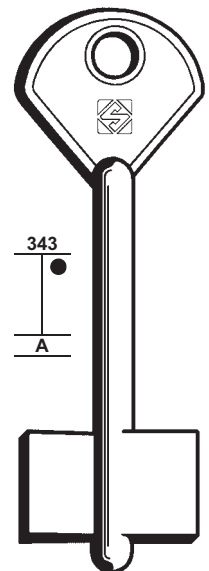

SD

CONFORTI

FOR:
PER:

SIS

SOLID

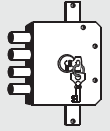

57

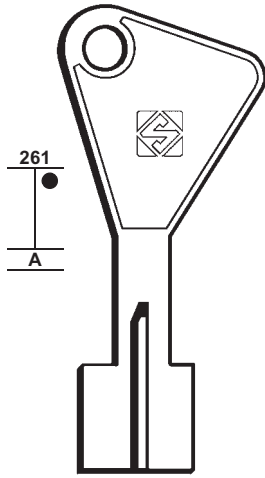

SSP3

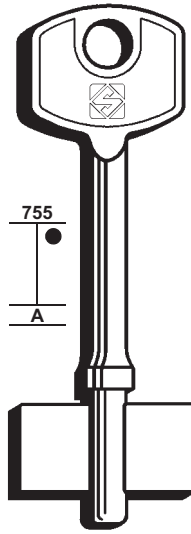

5SOL2

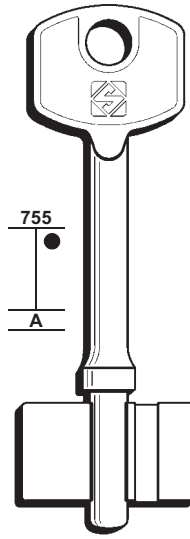

5SOL3

FOR/PER

SIS (P)

SOLID (ZA)
+ (67)

STAVER (LV)
CISA

STIEHM (D)
 (65-69-74-75)

STUV (D)
+ (70)

SWEDEN (S)
+ (66)

FOR:
PER:

STAVER

SWEDEN

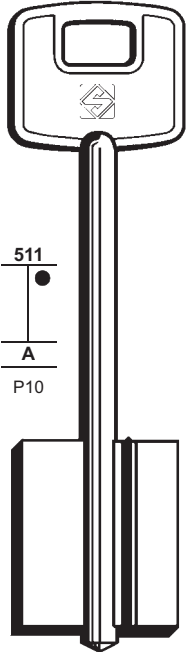

5CS2

CISA

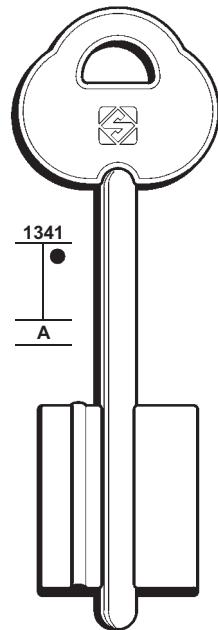

5STV1

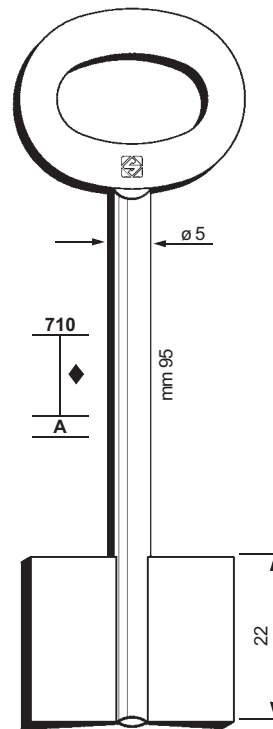

8695SSL

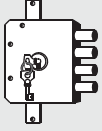

58

FOR/PER

TANN (S)
+ (70)

TESIO (I)
+ ESETY (24)

TITANO (I)

TO (I)
SECUREMME
TROLESE
+ SECUREMME (53)

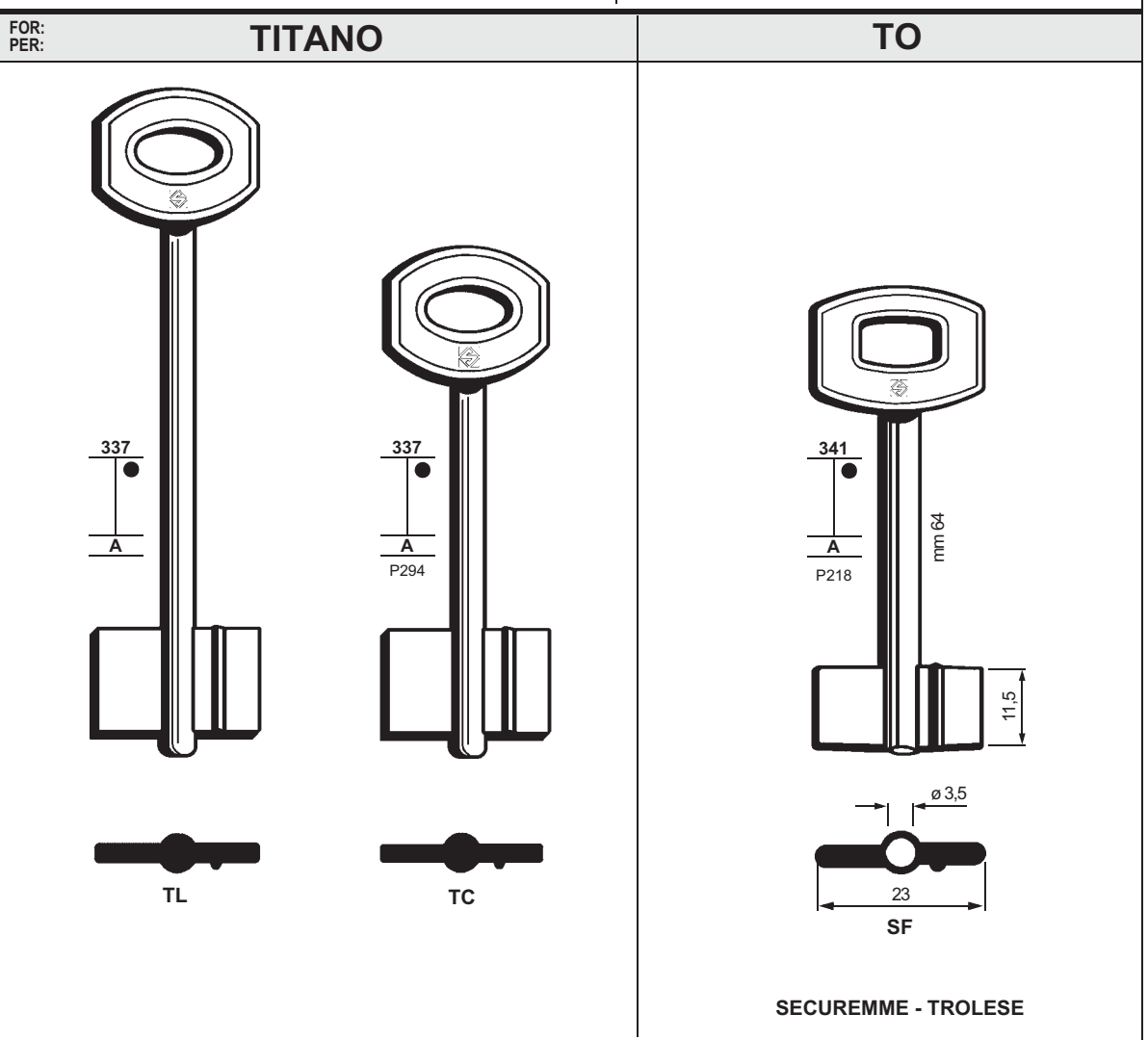
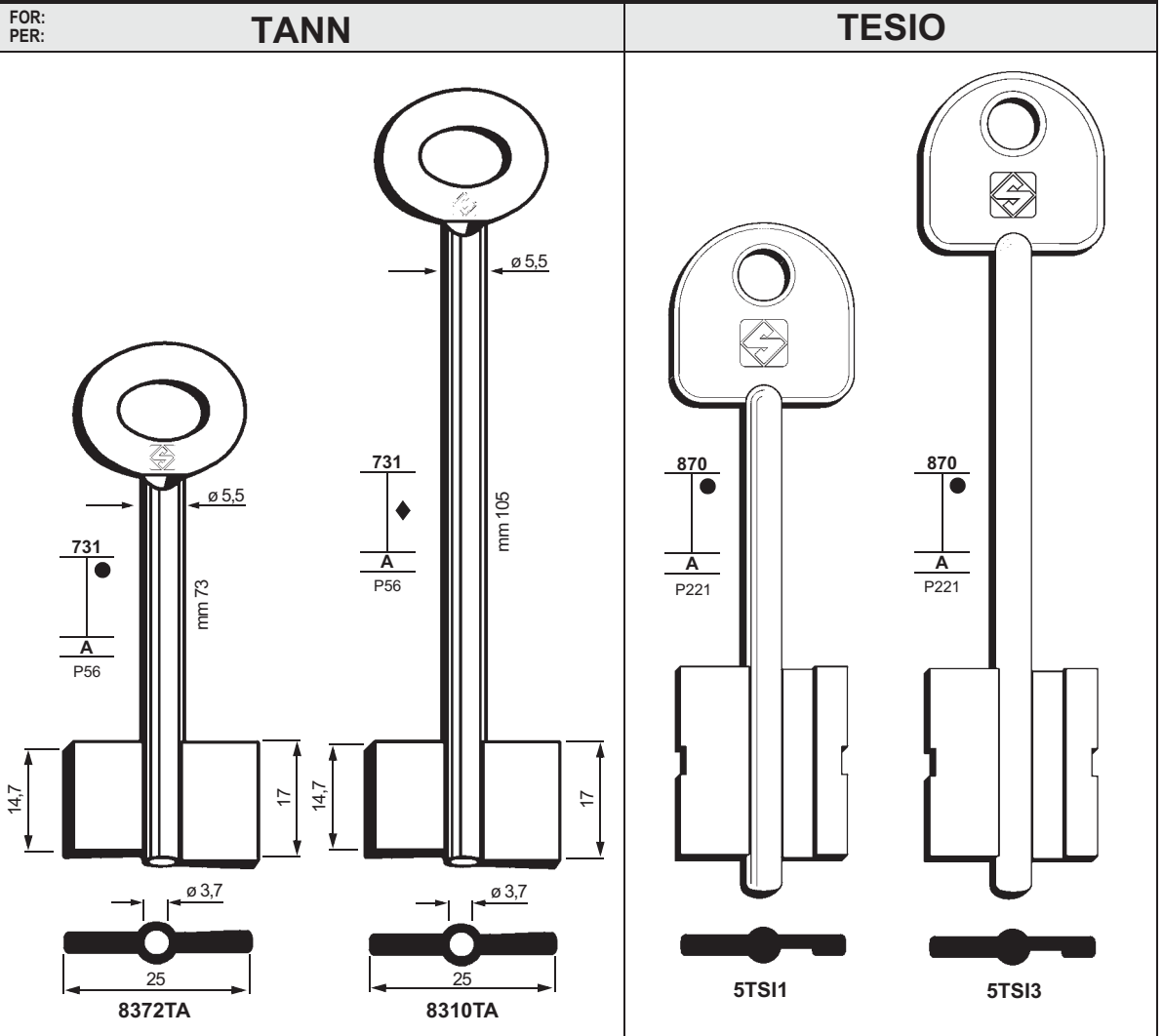

SECUREMME - TROLESE

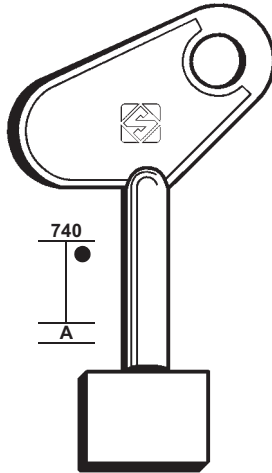
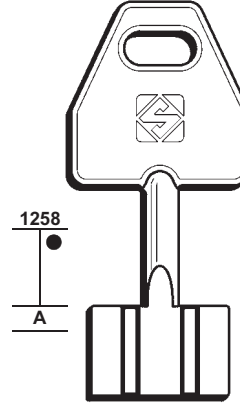
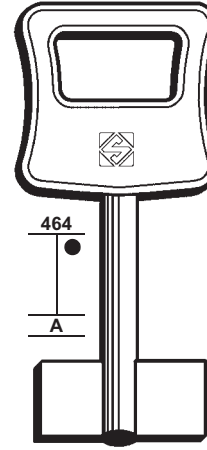
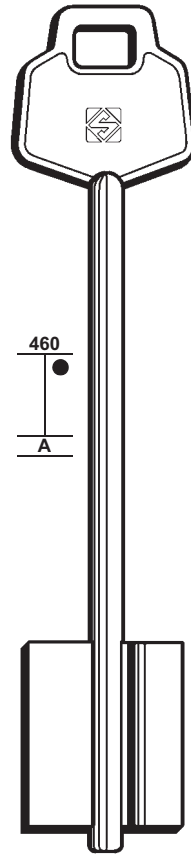
FOR: PER:	TOVER	TUSHINO	4 TR
	 <p>740 A</p> <p>5TV1</p>	 <p>1258 A</p> <p>5TU1</p>	 <p>464 A</p> <p>TRP</p>  <p>460 A</p> <p>TRL</p>

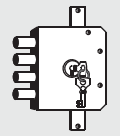

59

FOR/PER
TOVER (P)
TROLESE (I) SECUREMME (53) TO (58)
TUSHINO (RUS)
4 TR (I)
VAK (F) MUEL (46)
VILDETA (LT)
VIPER (I) POTENT (50)
VIRO (I) FEB CERUTTI (11-12-13) IDM (34-35) POTENT (49)

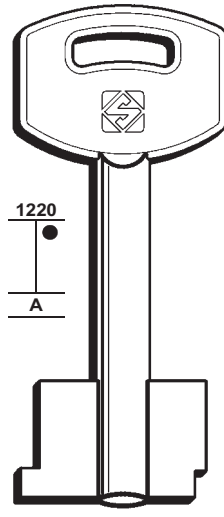
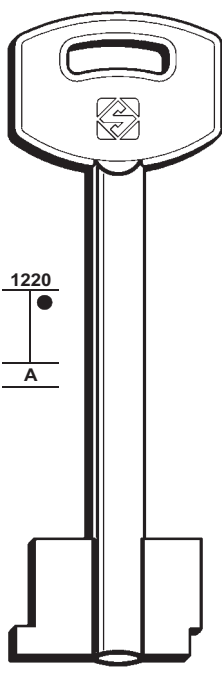
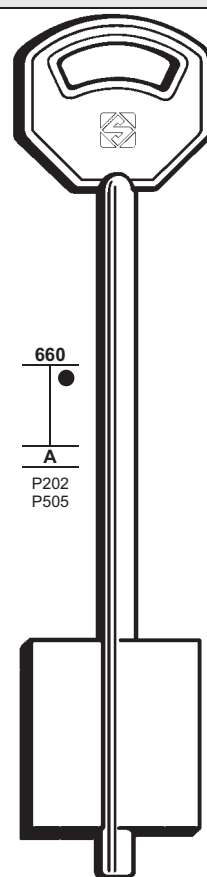
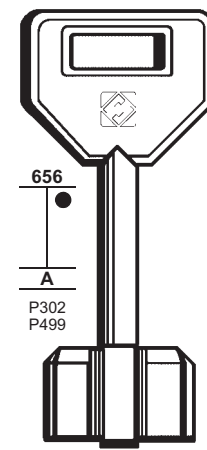
FOR: PER:	VILDETA	VIRO
	 <p>1220 A</p> <p>5VT1</p>  <p>1220 A</p> <p>5VT2</p>	 <p>660 A P202 P505</p> <p>5FEB3</p>  <p>656 A P302 P499</p> <p>5FEB5</p>

FEB

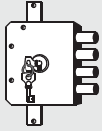

60

FOR/PER

WELKA (I)

WERTHEIM (D)

+ (79)

YALE (I)

KASSEL

+ FEB (28)

+ KASSEL (38)

FOR:
PER: WELKA

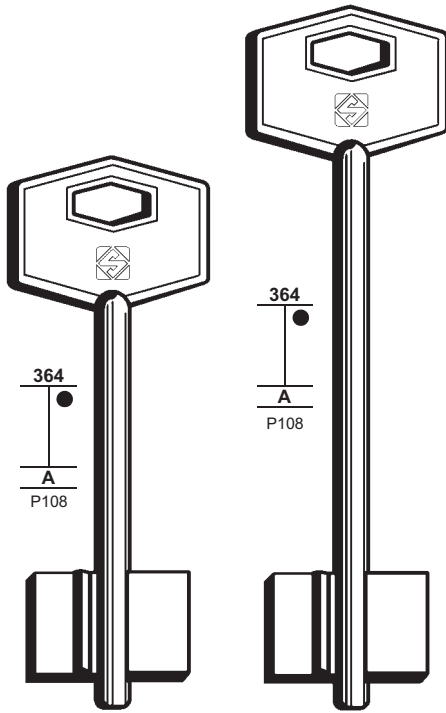

WM



W

YALE

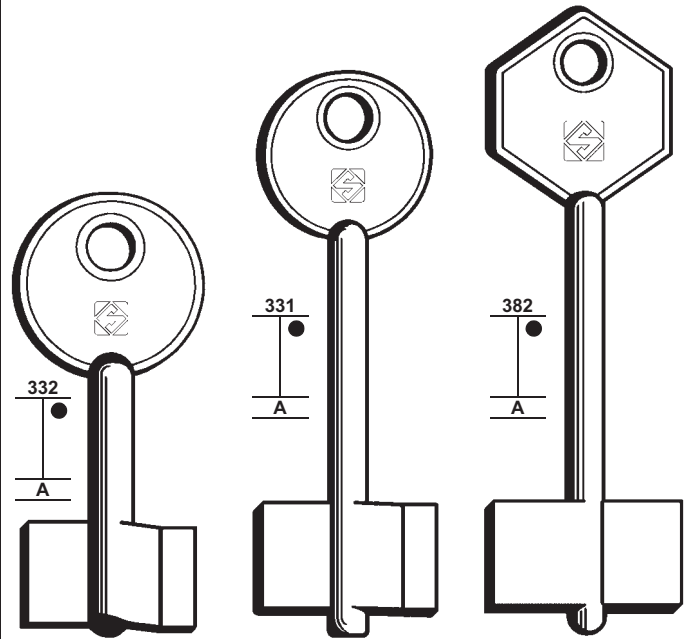

KYP



KC



YC

KASSEL

FOR:
PER:

YALE

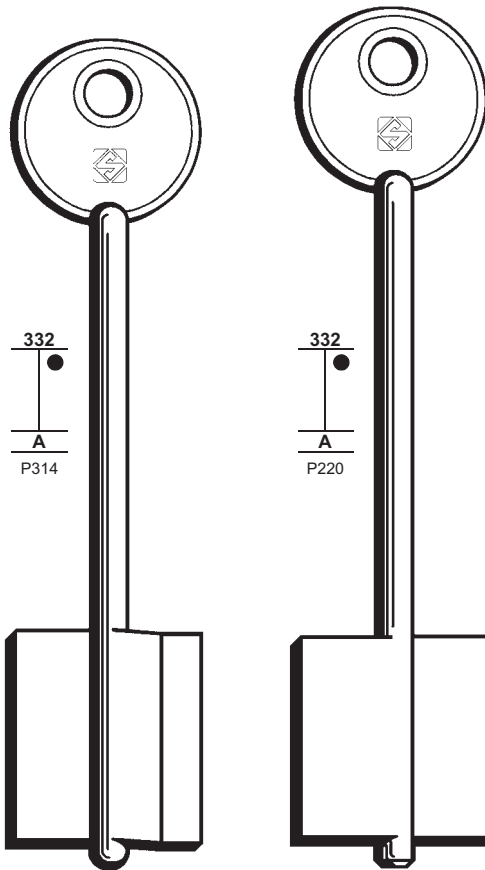

KYL



KL

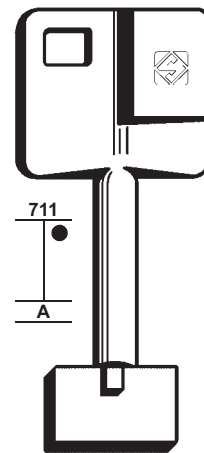

5YA1

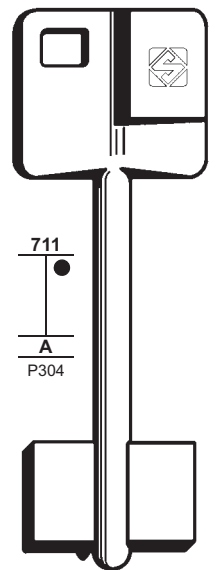

5YA4

KASSEL

FOR:
PER:

YALE

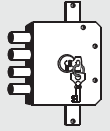

61

FOR/PER

YALE (1)

+ FEB (28)

+ KASSEL (38)

ZIME (1)

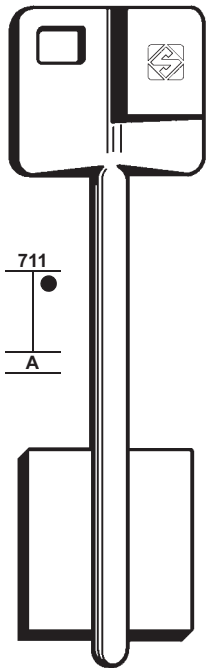

5YA6

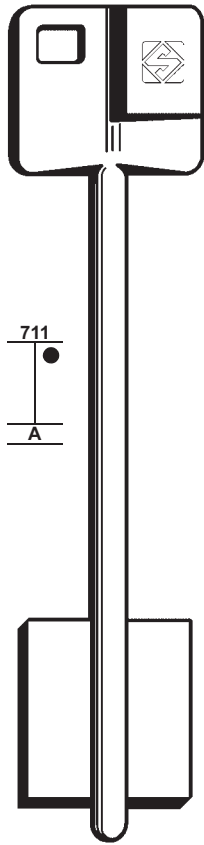

5YA8

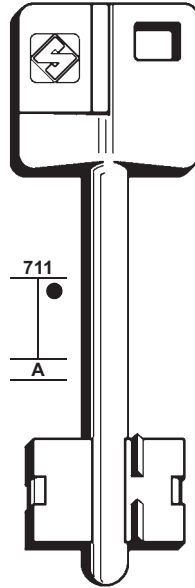

5YA20

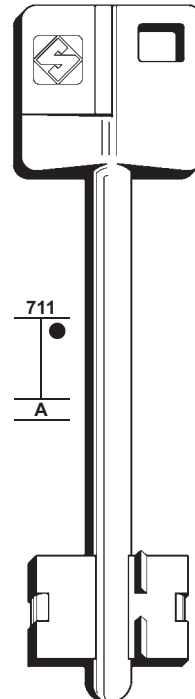

5YA22

FOR:
PER:

YALE

ZIME

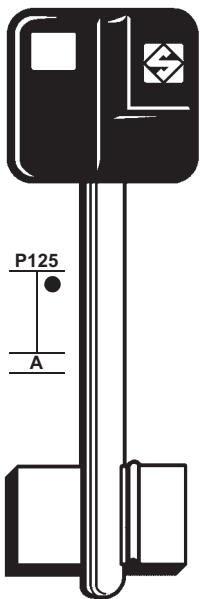

5YA10P

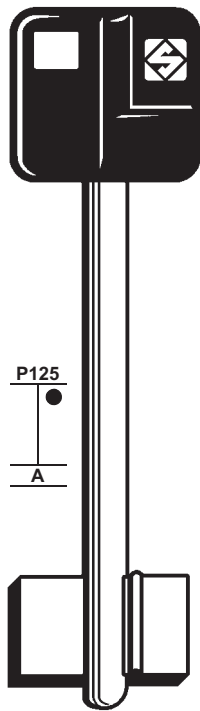

5YA14P

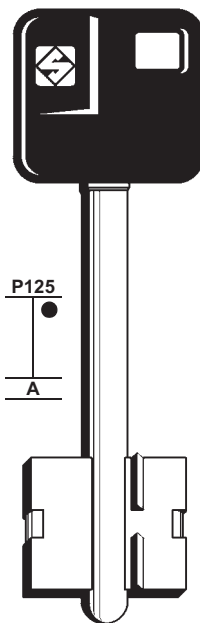

5YA18P

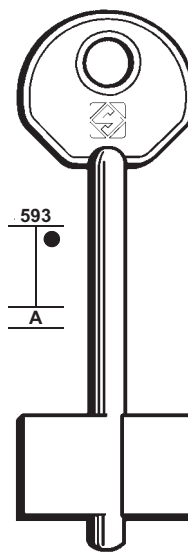

5ZM2



5YA9P



5YA13P



Safe keys
Chiavi per casseforti
Safeschlüssel
Clés pour coffre-forts
Llaves para cajas fuertes
Chaves para cofres

FOR:
PER:

MASCHI e FEMMINE per CASSAFORTE

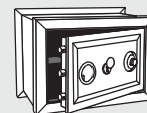

65

FOR/PER:
SECURITAS

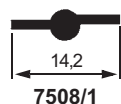
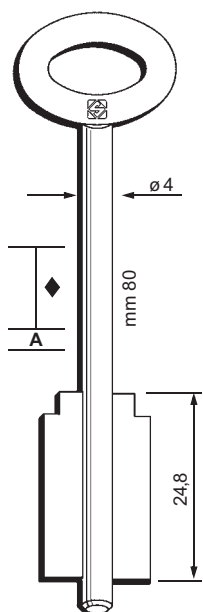

7508/1

FOR/PER:
SECURITAS

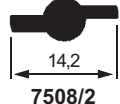
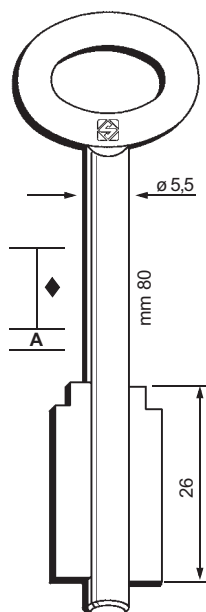

7508/2

FOR/PER:
BODE

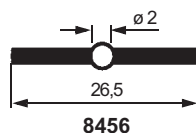
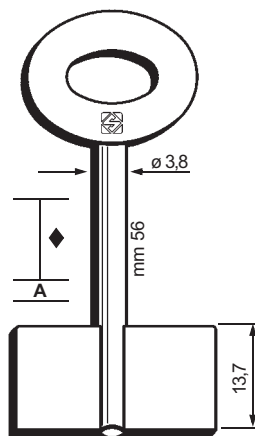

8456

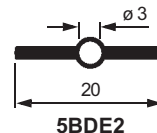
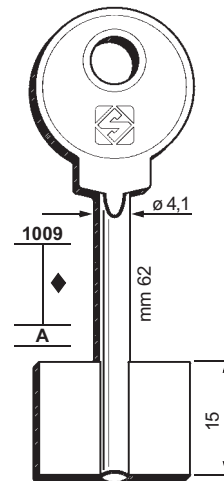

5BDE2

FOR/PER:
STIEHM

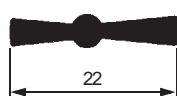
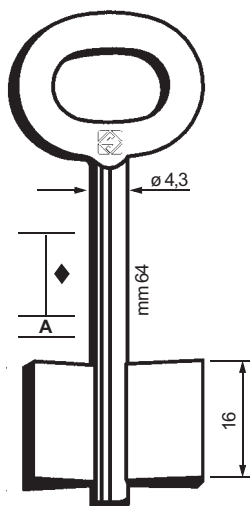

7161STM

FOR/PER:
GLITTENBERG

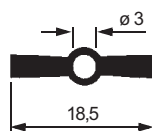
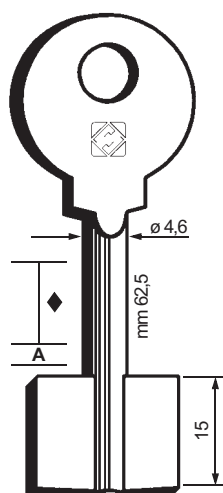

G464

FOR/PER:
STIEHM

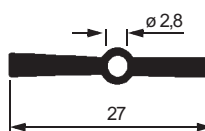
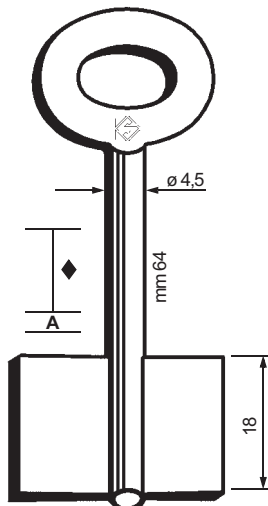

8164STM

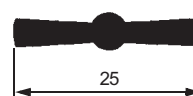
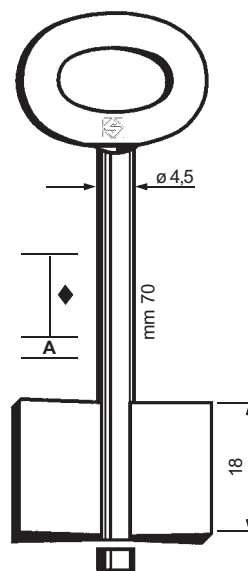

7107



8107

FOR/PER

BODE (D)

CAWI (D)

SELLA & VALZ (68)

GLITTENBERG (D)

SECURITAS (I)

STIEHM (D)

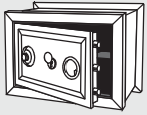

66

FOR/PER

FUMEO PARMA (I)

HAGELIN (S)

MELSMETALL (D)

SWEDEN (S)

FOR:
PER:

MASCHI e FEMMINE per CASSAFORTE

FOR/PER:
HAGELIN

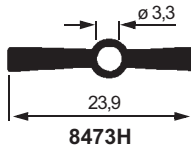
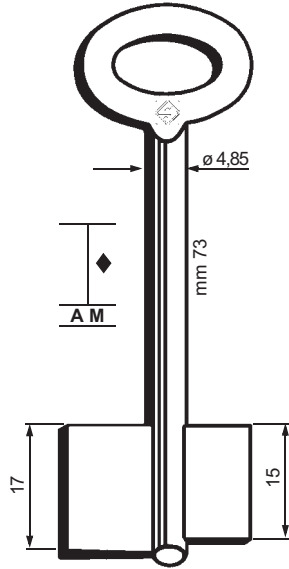
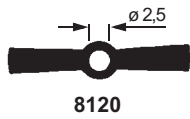
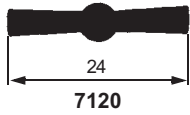
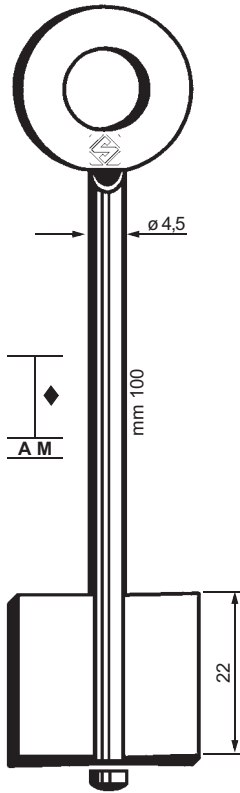

FOR/PER:
SWEDEN

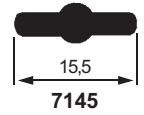
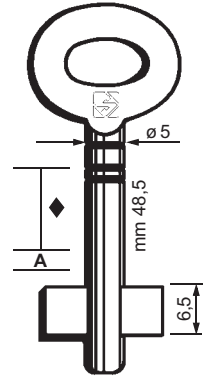
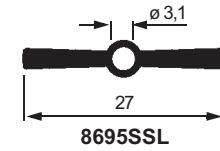
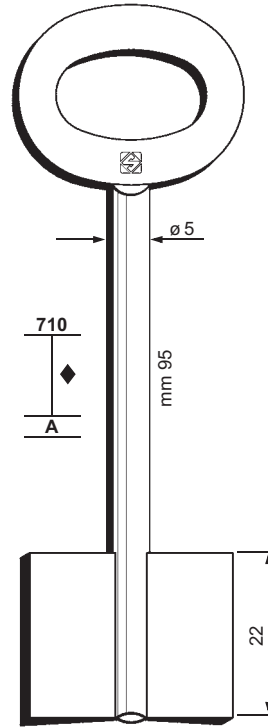

FOR/PER:
FUMEO-PARMA

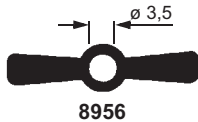
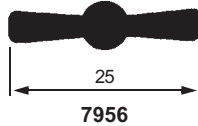
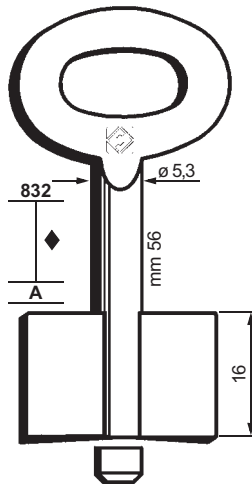
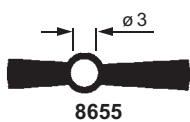
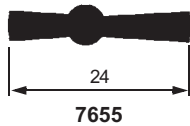
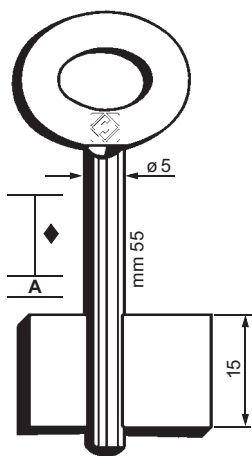

FOR/PER:
MELSMETALL

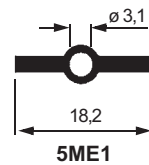
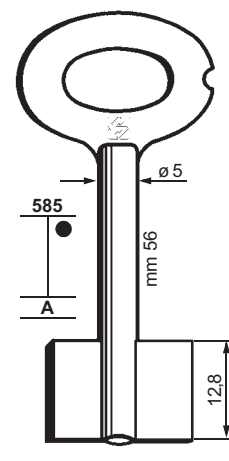

FOR/PER:
FUMEO-PARMA

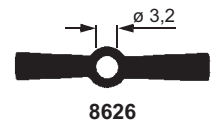
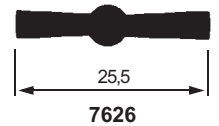
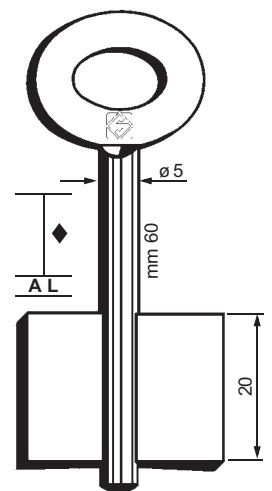

FOR:
PER:

MASCHI e FEMMINE per CASSAFORTE

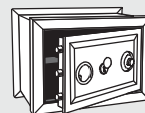

67

FOR/PER

BODE (D)

FASTA (I)

KROMER (D)

SOLID (ZA)

FOR/PER:
FASTA

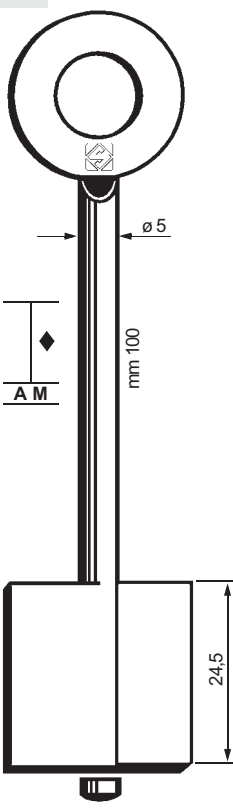
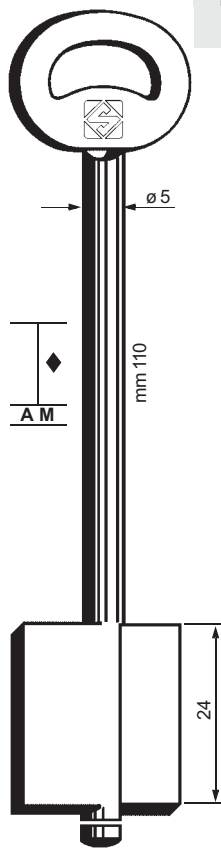

FOR/PER:
SOLID

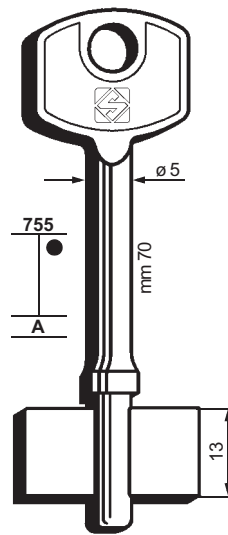

FOR/PER:
FASTA

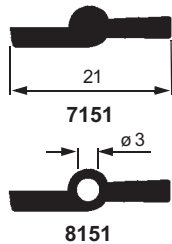
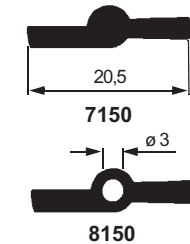
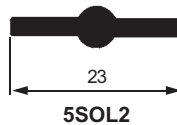
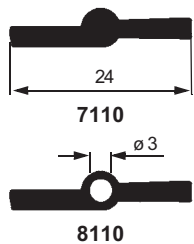
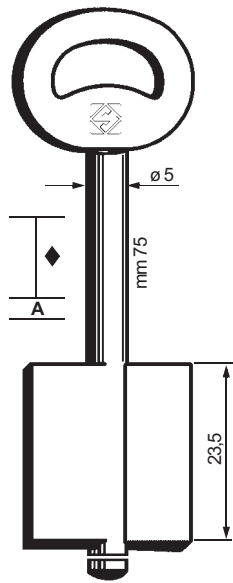

FOR/PER:
SOLID

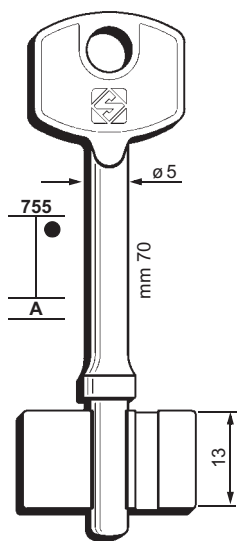

FOR/PER:
KROMER

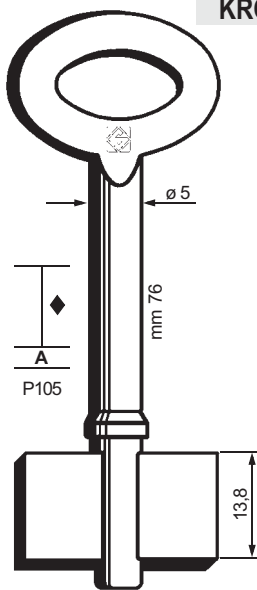

FOR/PER:
BODE

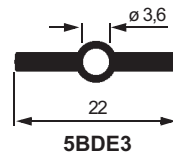
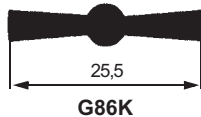
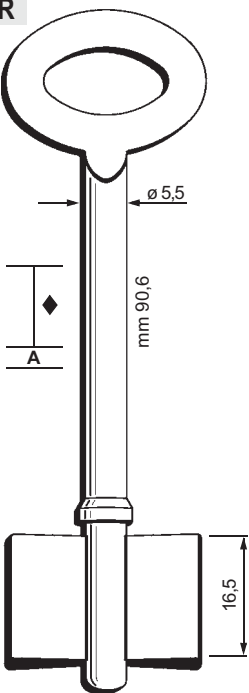
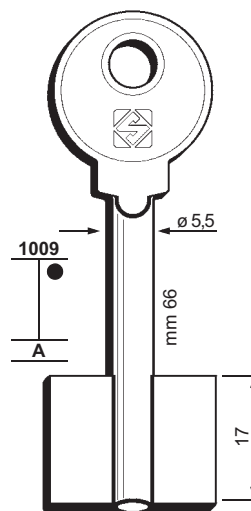

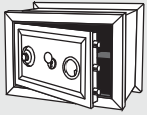

68

FOR/PER

SELLA & VALZ (I)
CAWI
WITTKOPP

FOR:
PER:

MASCHI e FEMMINE per CASSAFORTE

FOR/PER:
SELLA & VALZ

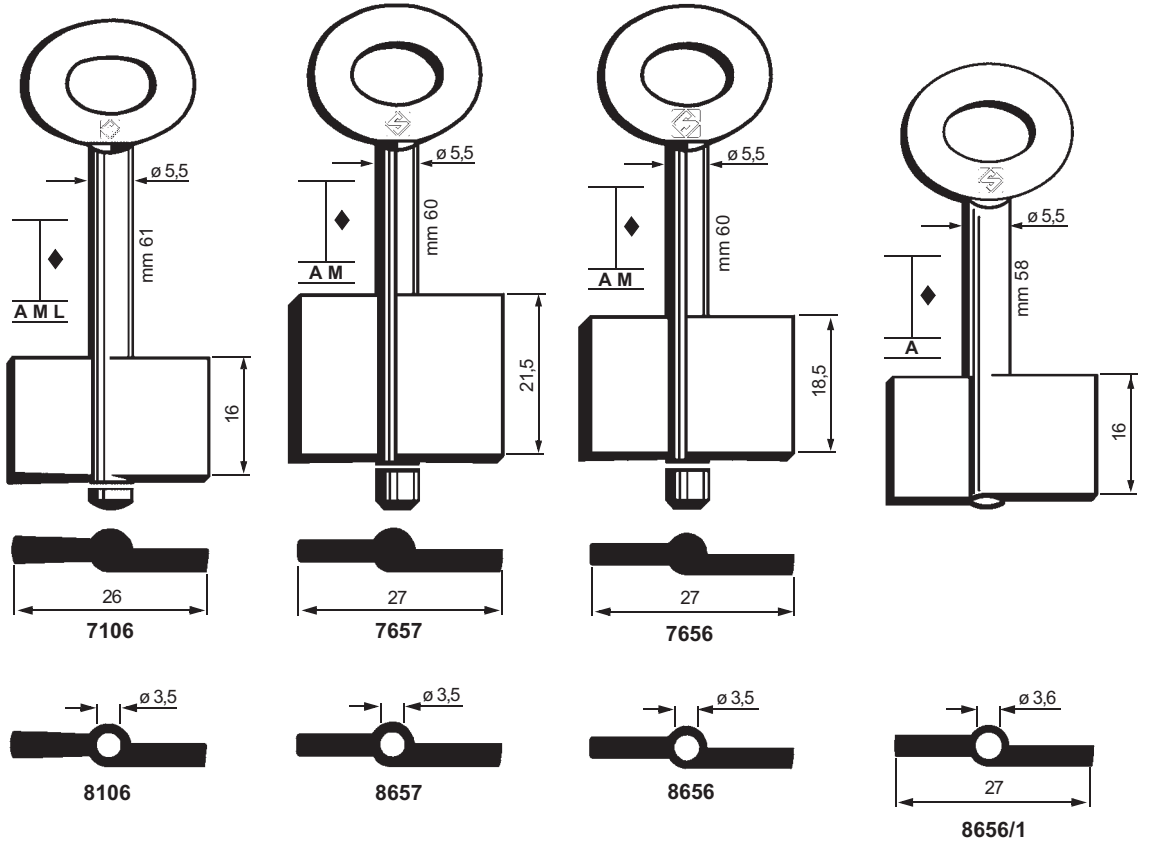

FOR/PER:
SELLA & VALZ

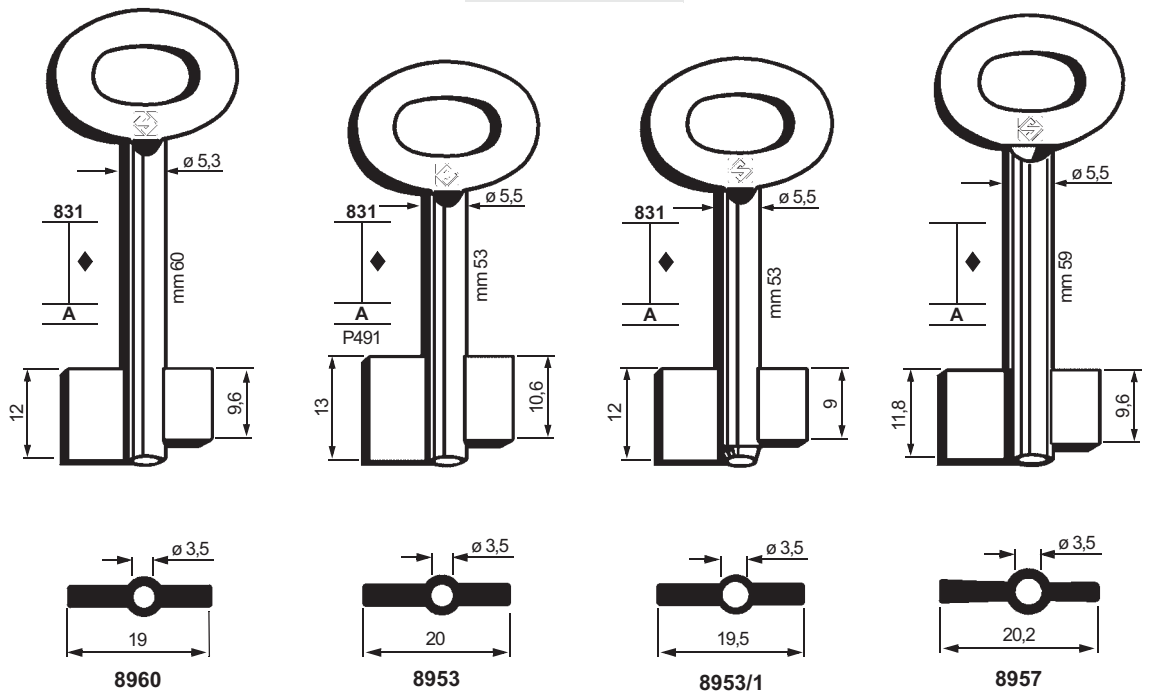

CAWI - WITTKOPP

Copyright by Silca S.p.A. 2010 - All rights reserved

FOR:
PER:

MASCHI e FEMMINE per CASSAFORTE

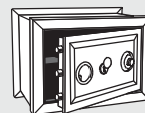

69

FOR/PER

CECCHERELLI (I)

FUMEO-PARMA (I)

STIEHM (D)

FOR/PER:
STIEHM

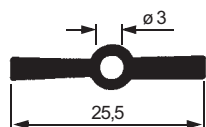
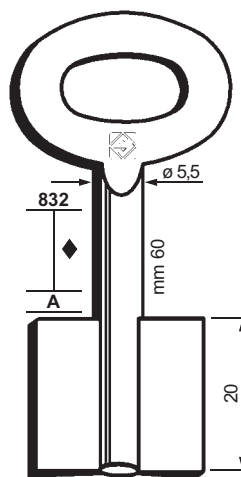
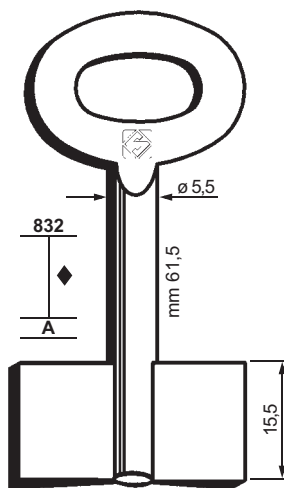
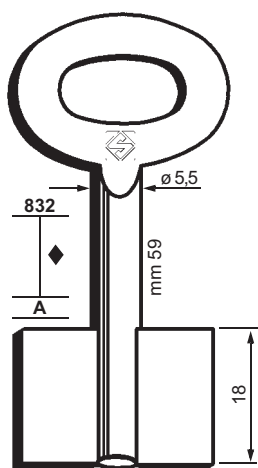
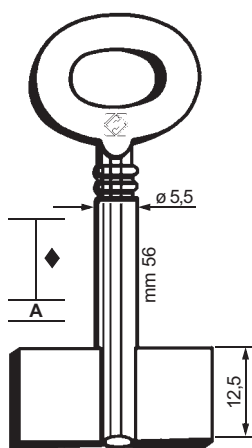

8156STM

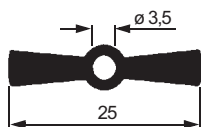

8958

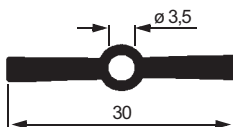

8958/1

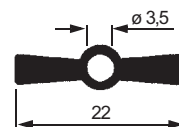

8961

FOR/PER:
STIEHM

FOR/PER:
CECCHERELLI

FOR/PER:
FUMEO-PARMA

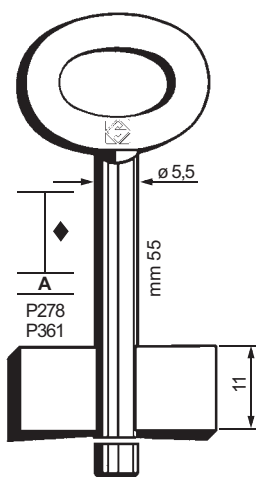
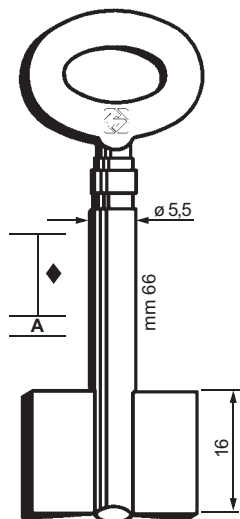

7455

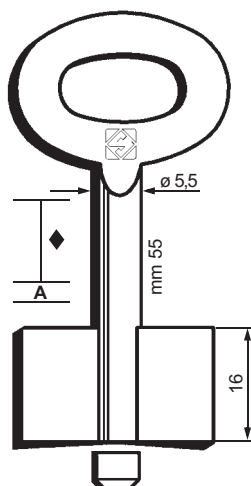

7956/1

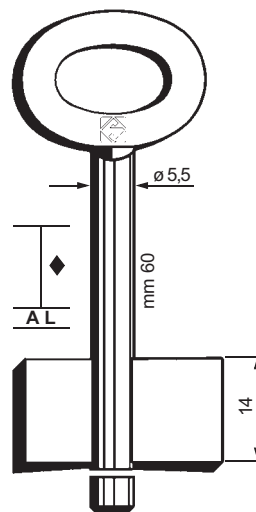

7606

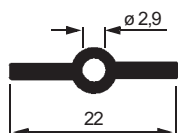

8166STM

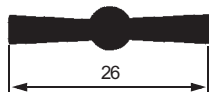

8455

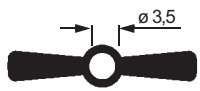
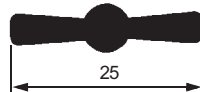

8956/1



8606

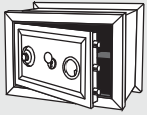

70

FOR/PER

ASSA (S)

ELZETT (H)

SIBI (I)

STUV (D)

TANN (D)

FOR:
PER:

MASCHI e FEMMINE per CASSAFORTE

FOR/PER:
SIBI

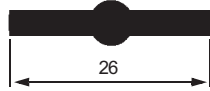
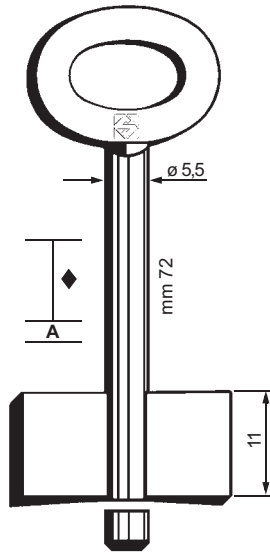

7659



8659

FOR/PER:
ELZETT

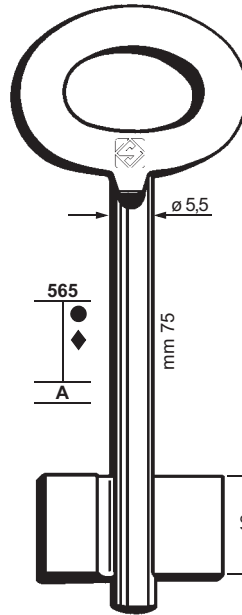

7308E

FOR/PER:
STUV-TANN

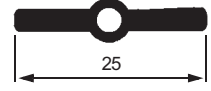
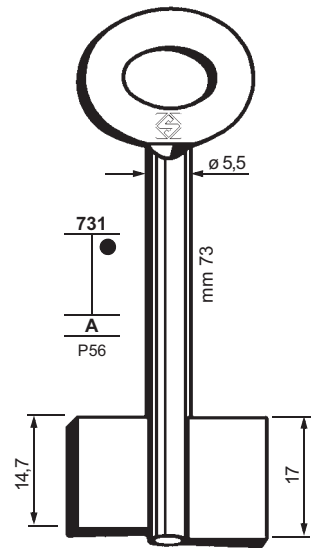

8372TA

FOR/PER:
STUV-TANN

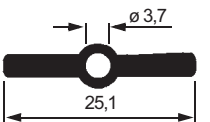
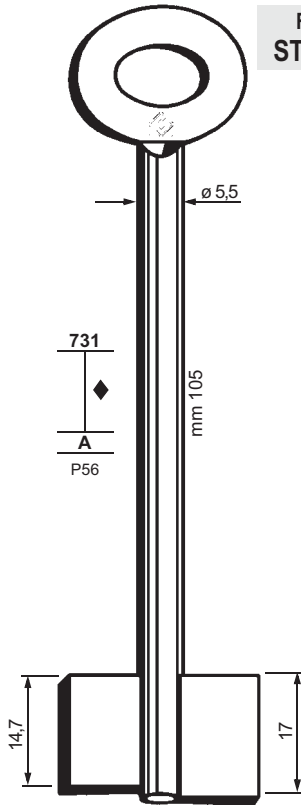

8310TA

FOR/PER:
ASSA

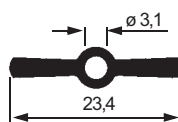
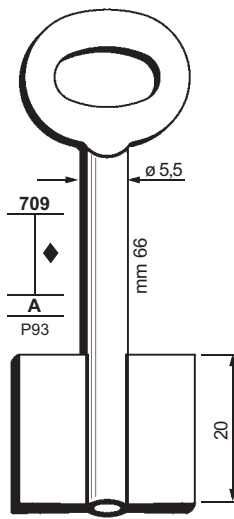

8466ASS

FOR/PER:
ASSA

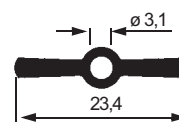
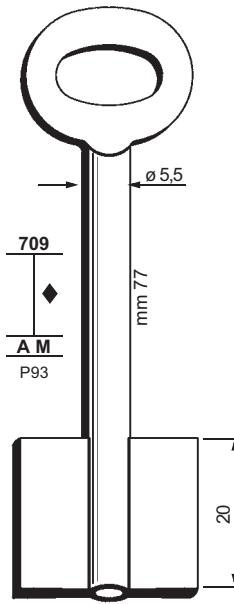

8477ASS

FOR/PER:
ASSA

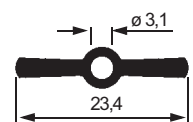
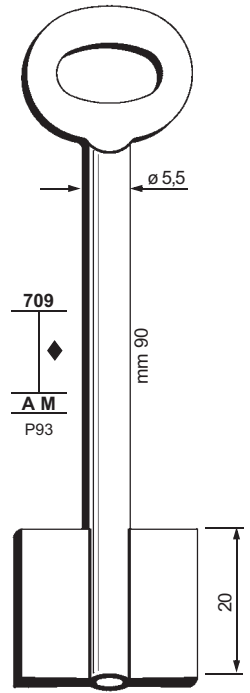

8490ASS

FOR:
PER:

MASCHI e FEMMINE per CASSAFORTE

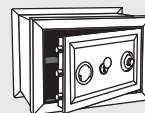

71

FOR/PER:
ROSENGREN

FOR/PER:
ROSENGREN

FOR/PER:
LIPS-VAGO

FOR/PER:
CONFORTI

FOR/PER

CONFORTI (I)

LIPS-VAGO (I)

ROSENGREN (S)

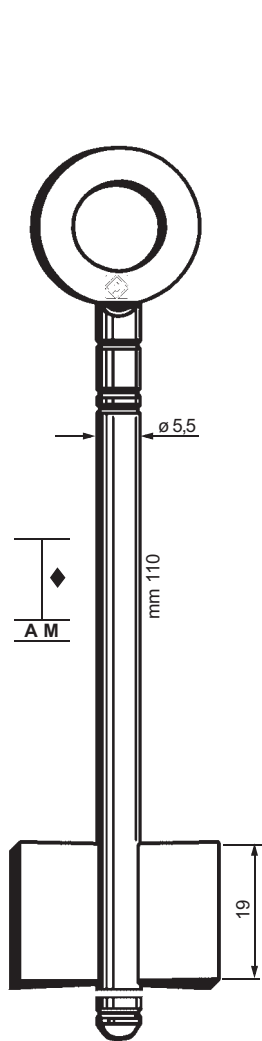

7211



8211

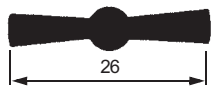
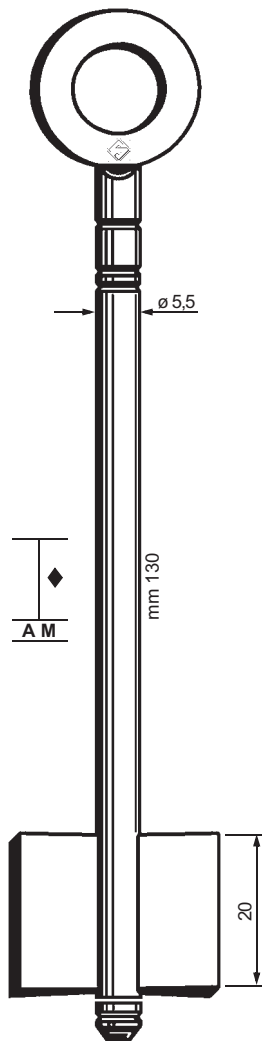

7213



8213

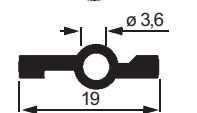
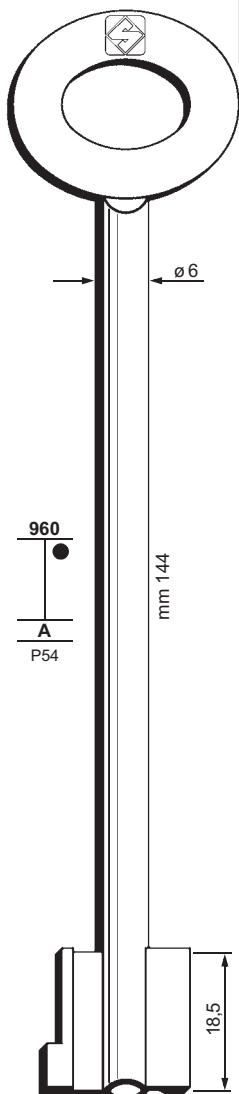

5RSG1

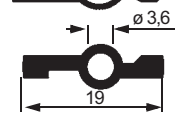
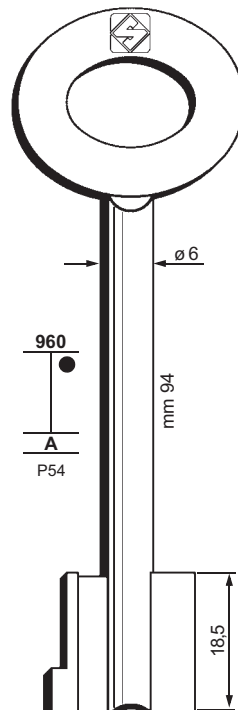

5RSG2

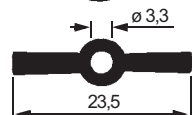
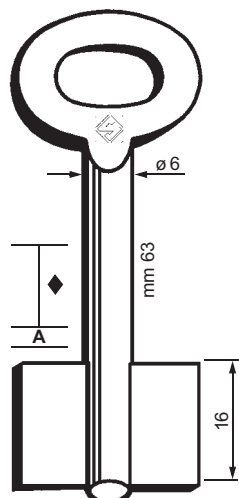

8963

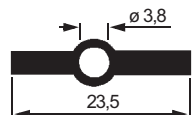
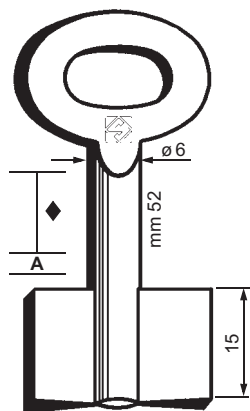

8951

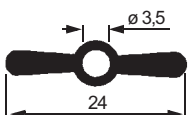
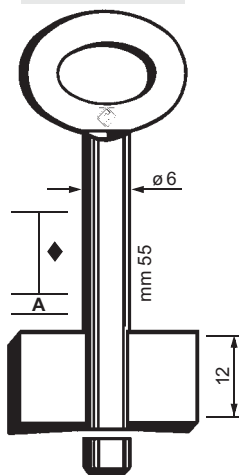

8405

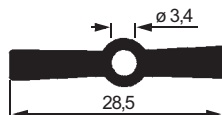
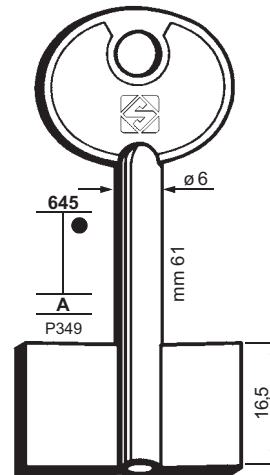

5LV1



7405

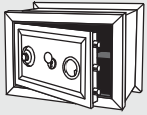

72

FOR/PER

CONFORTI (I)

PARMA-PAS (I)

SECURCASA (I)

FOR:
PER:

MASCHI e FEMMINE per CASSAFORTE

FOR/PER:
PARMA-PAS

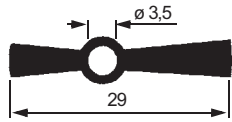
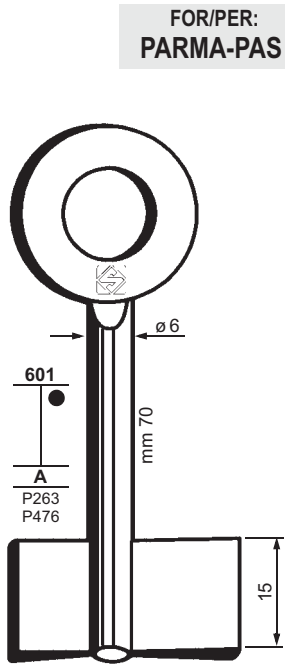

8370PA

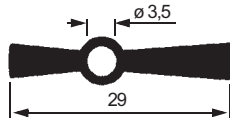
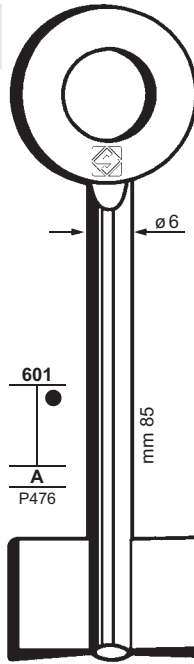

8385PA

FOR/PER:
SECURCASA

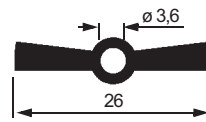
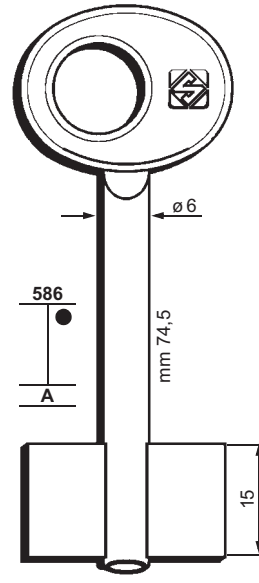

8367S

FOR/PER:
CONFORTI

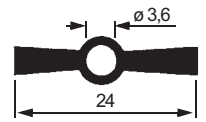
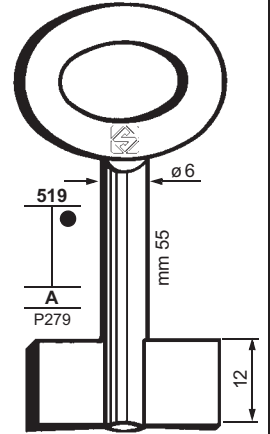

8355C

FOR/PER:
CONFORTI

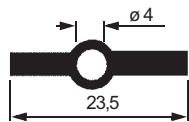
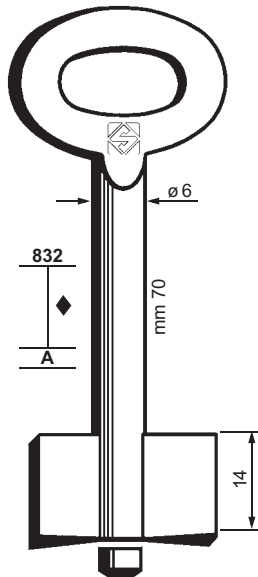

8972



7972

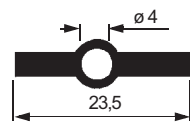
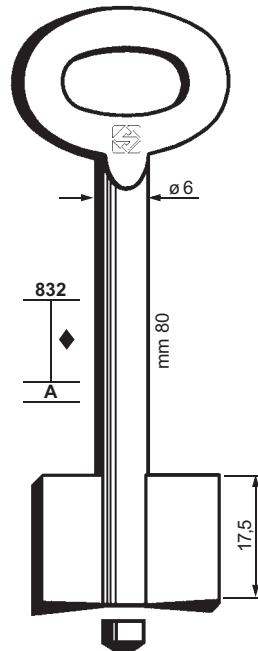

8980



7980

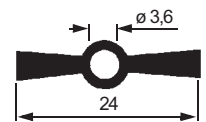
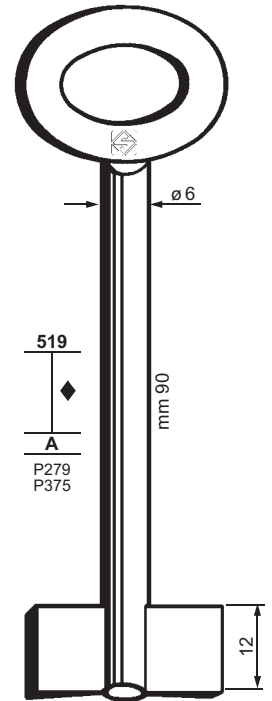

8388C

FOR:
PER:

MASCHI e FEMMINE per CASSAFORTE

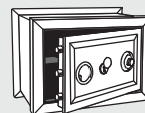

73

FOR/PER:
ROLEX

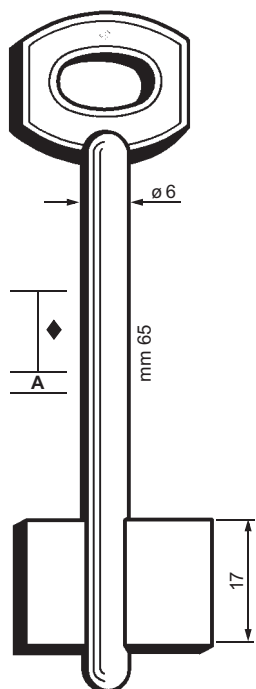

FOR/PER:
MELSMETALL

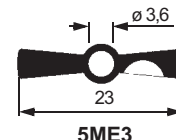
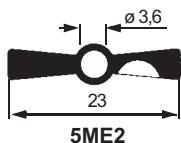
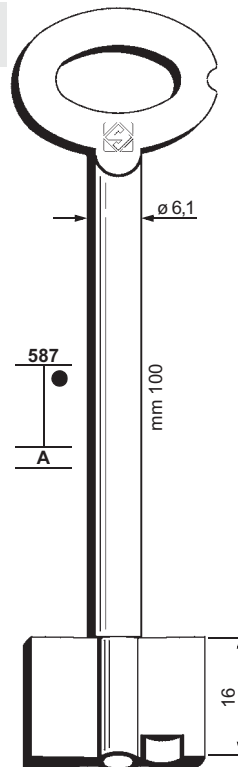
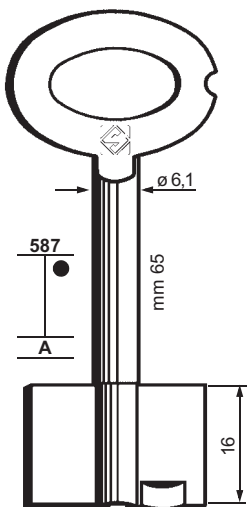

FOR/PER:
CONFORTI

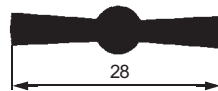
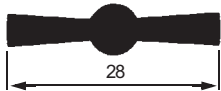
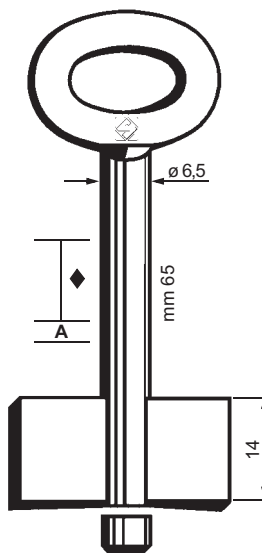
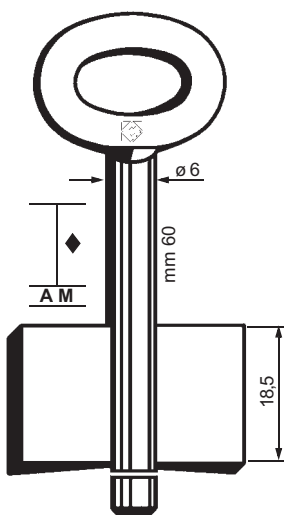
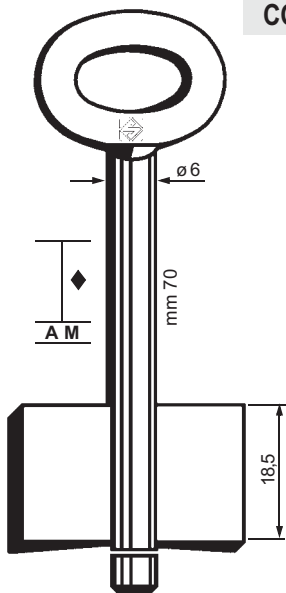
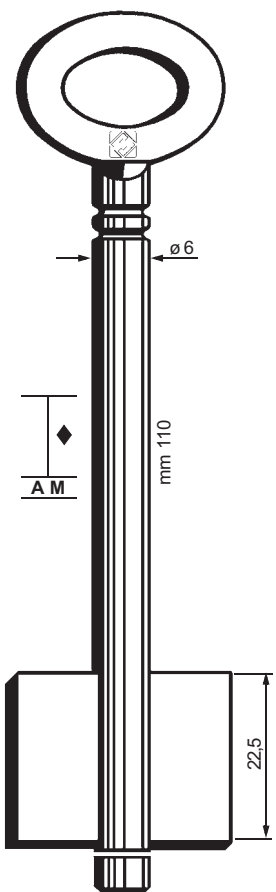

7211/2

7207

7206

7406



8211/2

8207

8206

8406

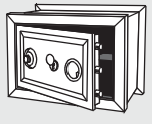

74

FOR/PER
STIEHM (D)

FOR:
PER:

MASCHI e FEMMINE per CASSAFORTE

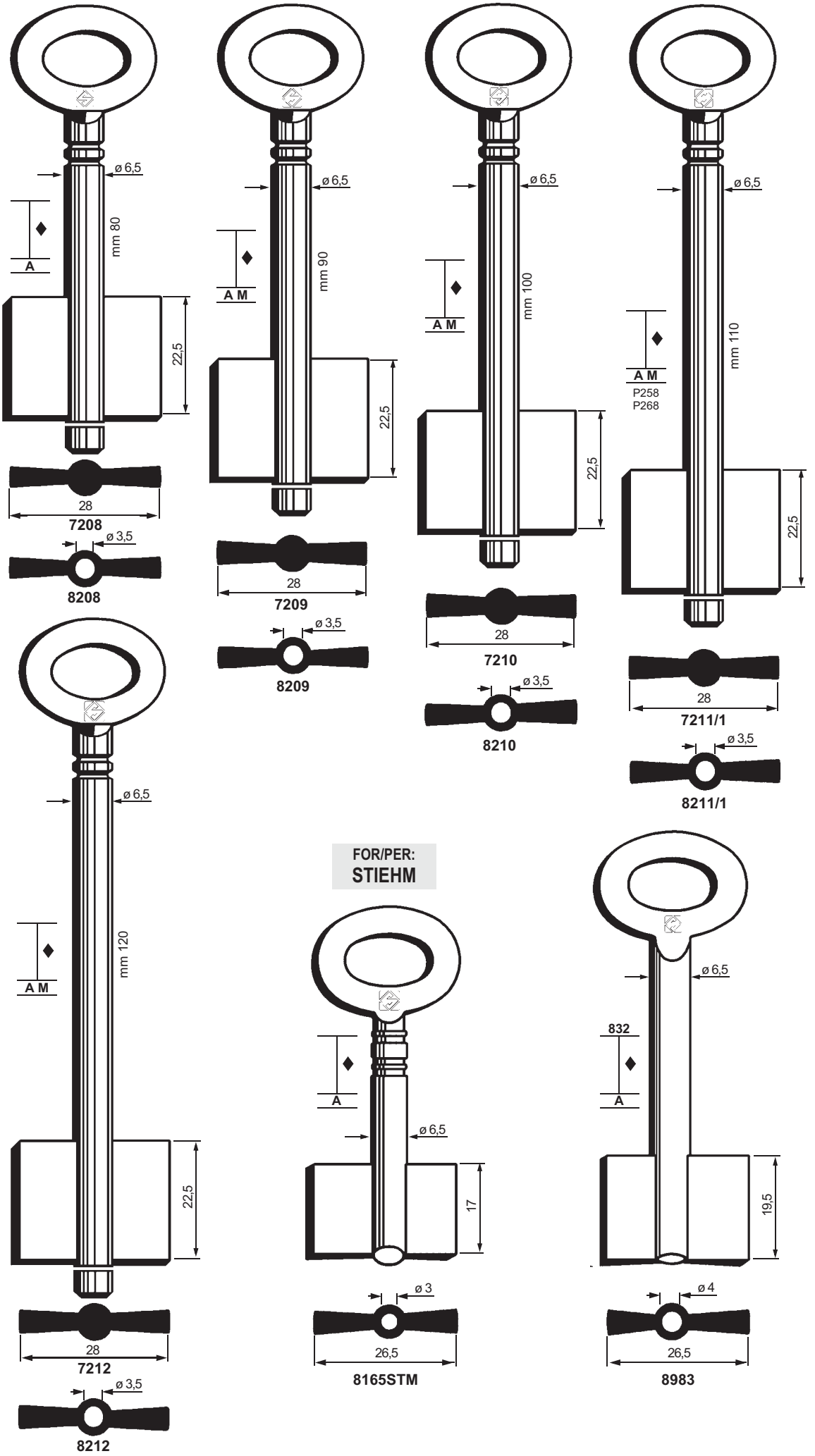

FOR/PER:
STIEHM

FOR:
PER:

MASCHI e FEMMINE per CASSAFORTE

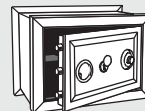

75

FOR/PER
STIEHM (D)

FOR/PER:
STIEHM

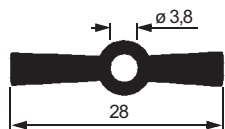
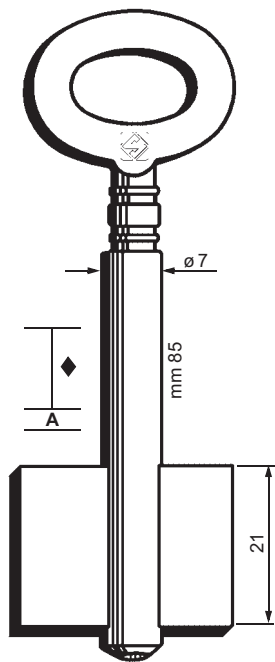

8181STM

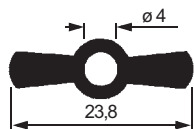
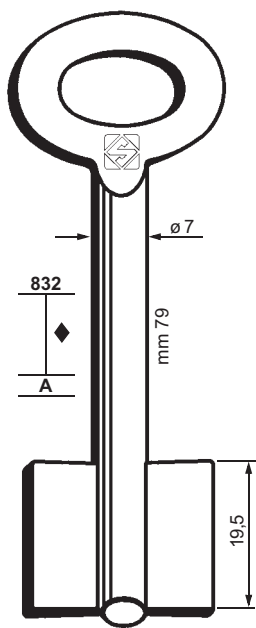

8977

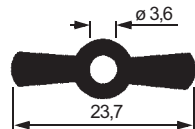
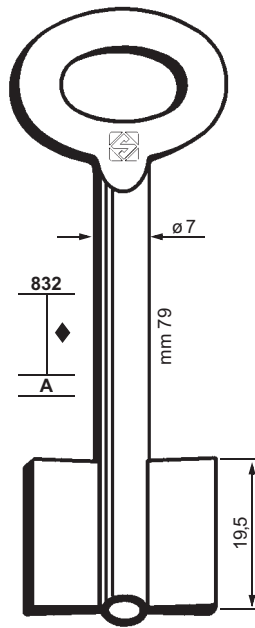

8978

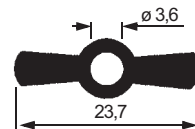
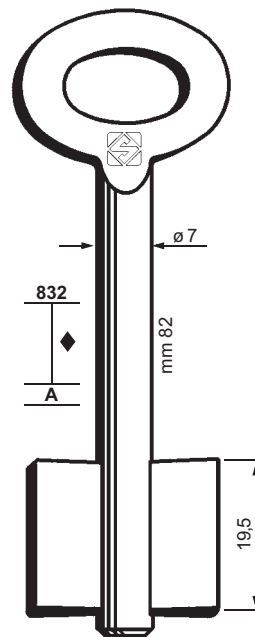

8978/1

FOR/PER:
STIEHM

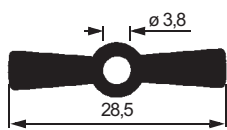
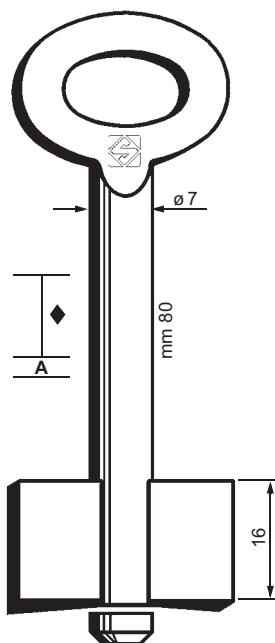

8979

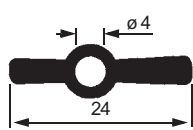
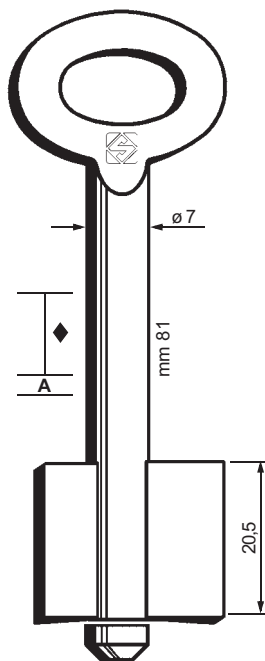

8981

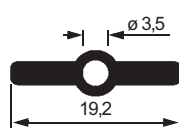
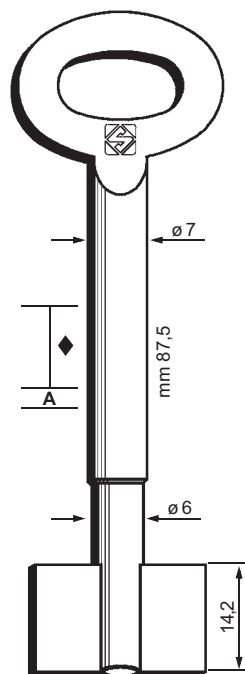

8990

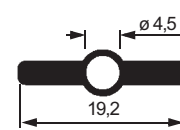
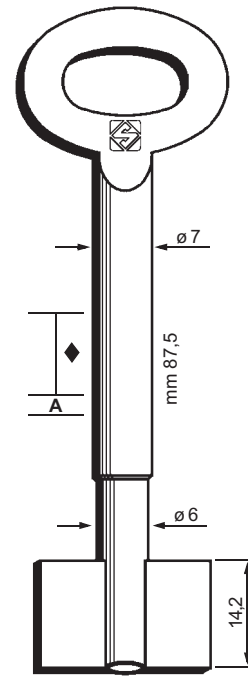

8990/1



7979



7981

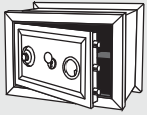

76

FOR/PER
CORBIN (I)
PARMA (I)

FOR:
PER:

MASCHI e FEMMINE per CASSAFORTE

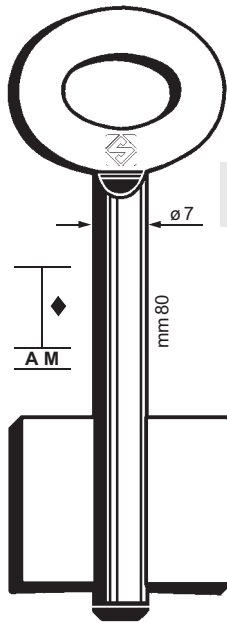

FOR/PER:
CORBIN

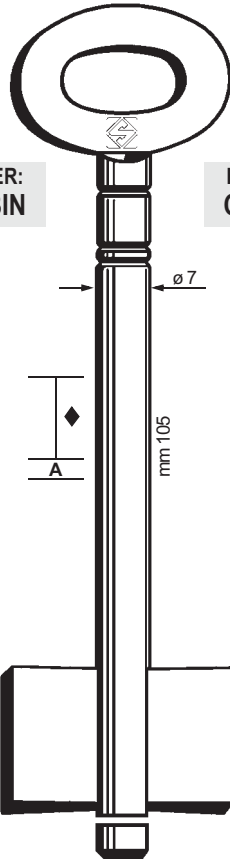

FOR/PER:
CORBIN

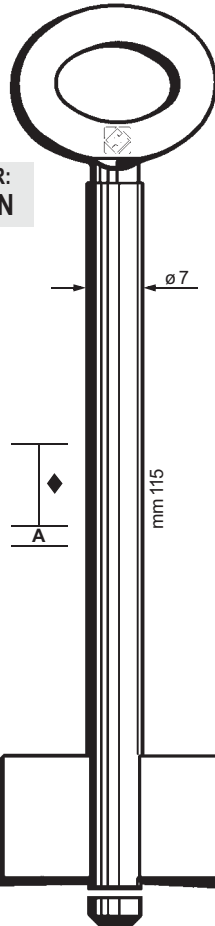

FOR/PER:
PARMA

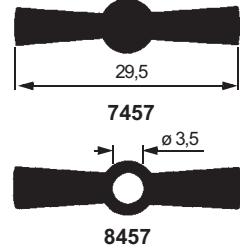
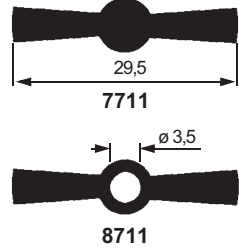
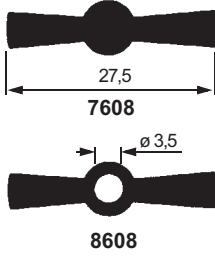
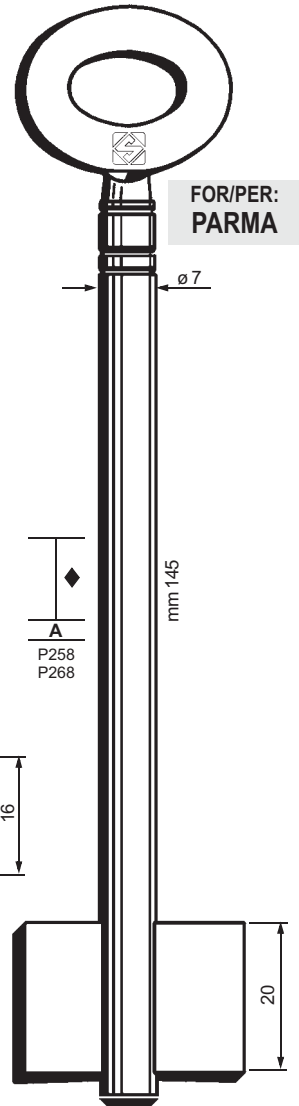

FOR/PER:
PARMA

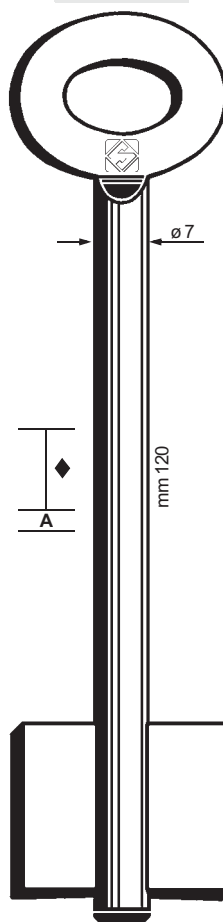

FOR/PER:
CORBIN

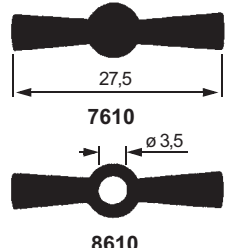
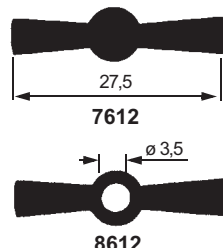
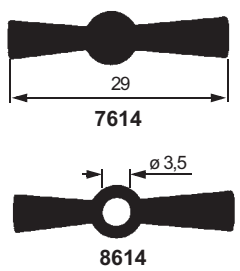
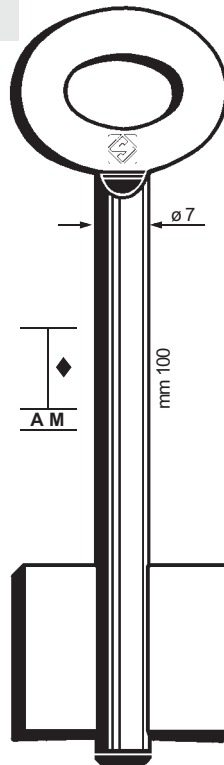

FOR:
PER:

MASCHI e FEMMINE per CASSAFORTE

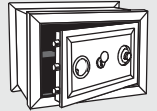

77

FOR/PER
DUTO (l)

FOR/PER:
DUTO

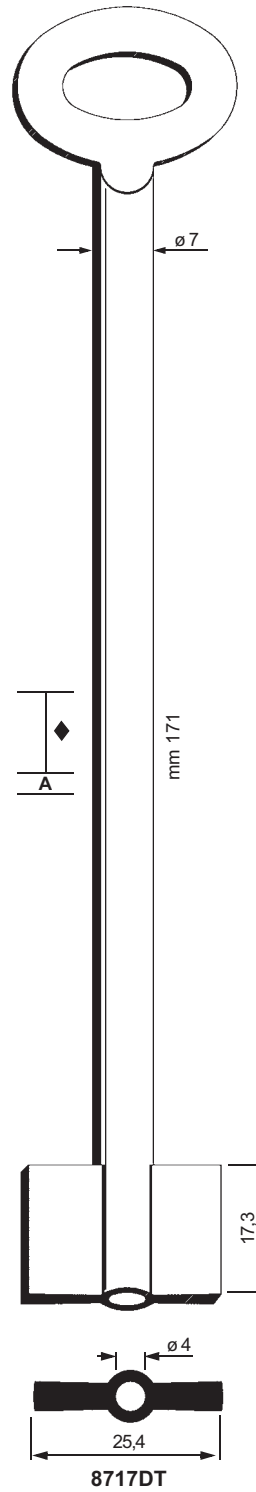

FOR/PER:
DUTO

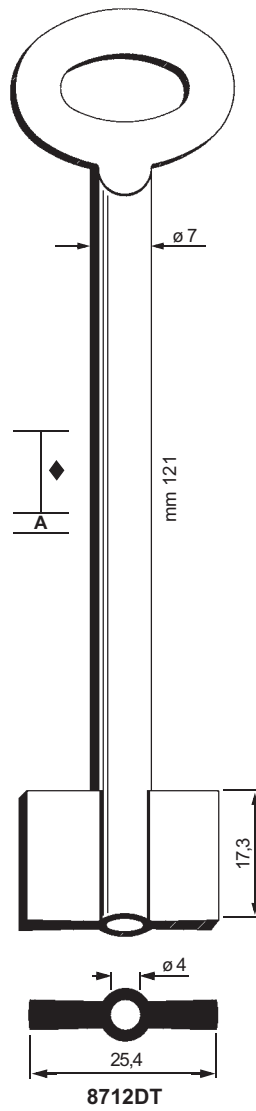

FOR/PER:
DUTO

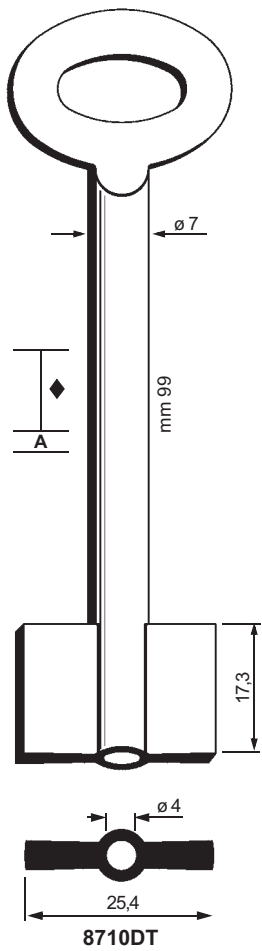

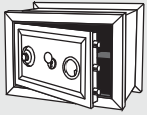

78

FOR/PER

DUTO (I)

PARMA-PAS (I)

FOR:
PER:

MASCHI e FEMMINE per CASSAFORTE

FOR/PER:
DUTO

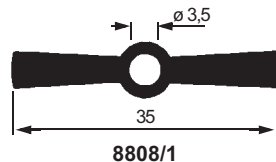
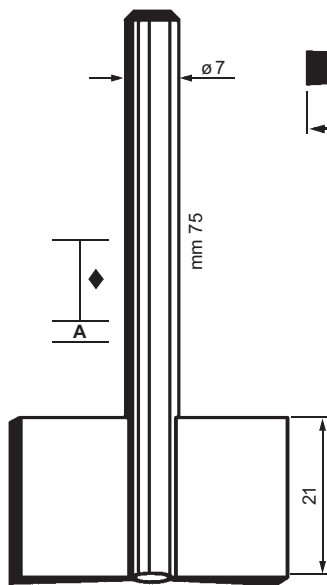
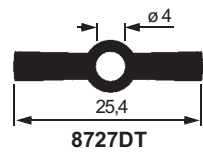
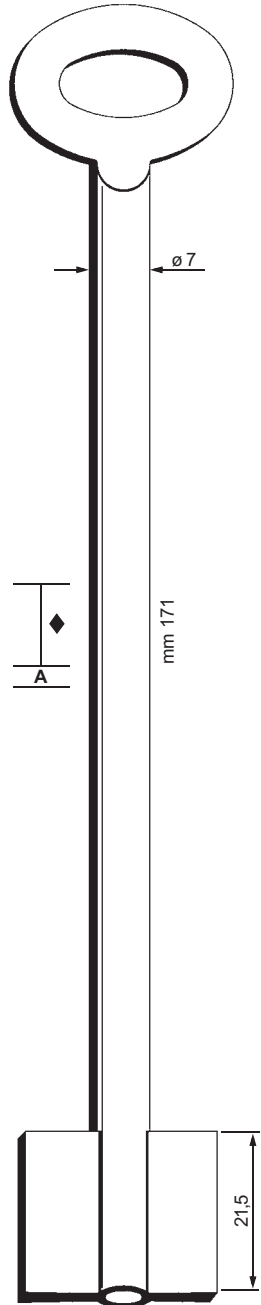

FOR/PER:
PARMA-PAS

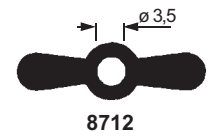
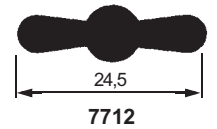
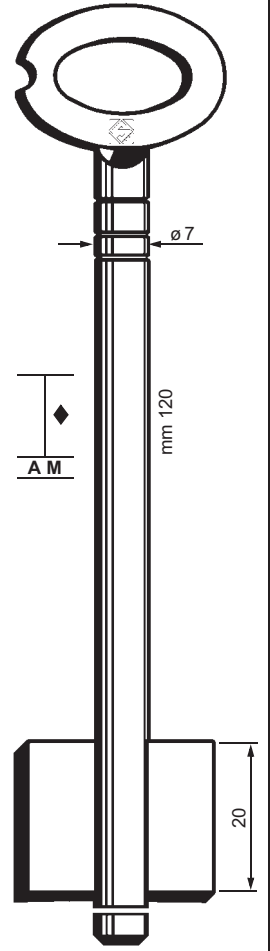
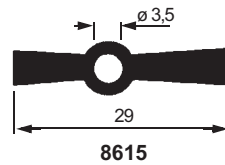
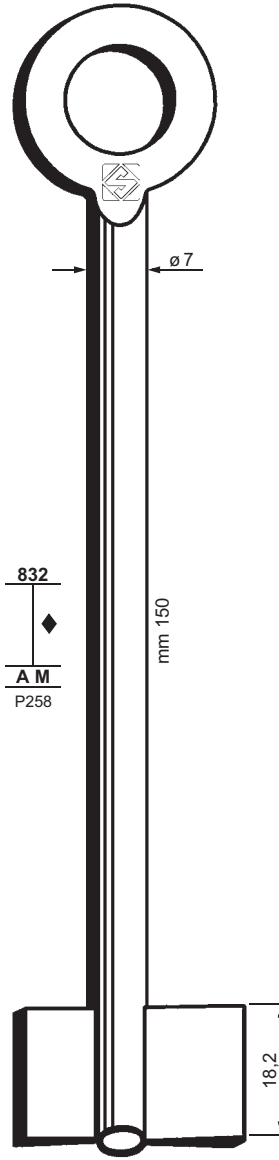

FOR:
PER:

MASCHI e FEMMINE per CASSAFORTE

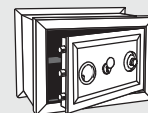

79

FOR/PER

WERTHEIM (D)

WITTKOPP (D)

SELVA & VALZ (68)

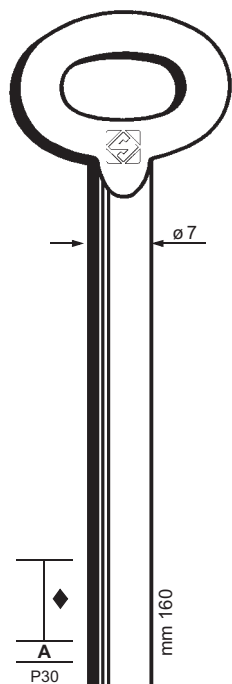

FOR/PER:
WERTHEIM

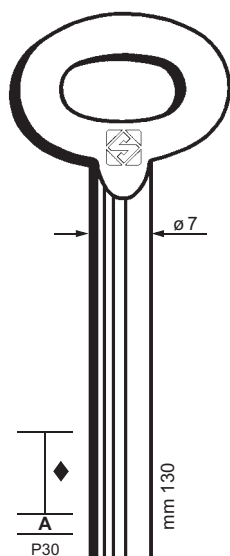
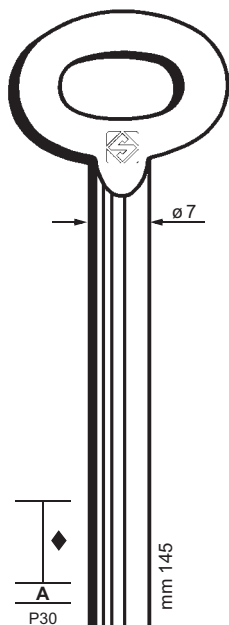

FOR/PER:
WERTHEIM

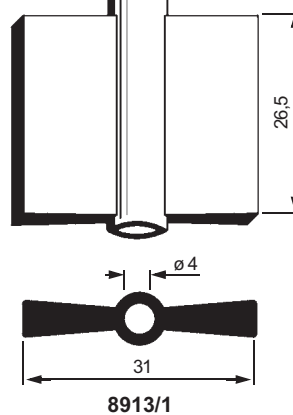
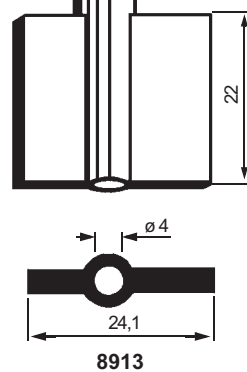
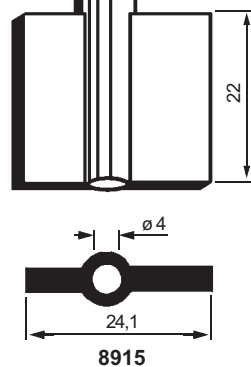
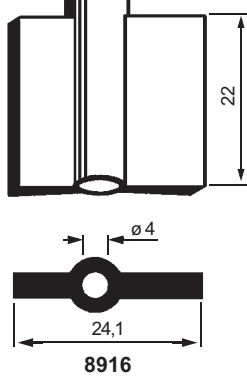
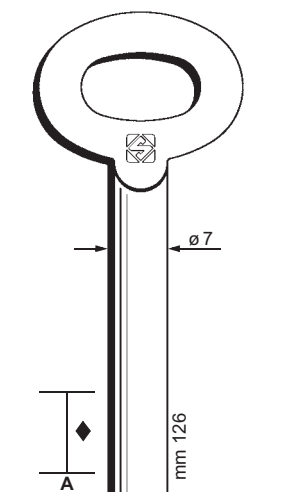



Pin, muzzle and “Cadorine” keys
Chiavi a gorges, grugno e “Cadorine”
Gorges-, Faust- und Cadorineschlüssel
Clés à gorges, à groin et “Cadorine”
Llaves a gorja, a puño y “Cadorine”
Chaves tipo gorges, “Grugno” e “Cadorine”

FOR:
PER: **ALDRIDGE**

ALEDAL

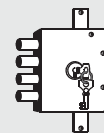

83

FOR/PER

ALDRIDGE (GB)

ALEDAL (S)

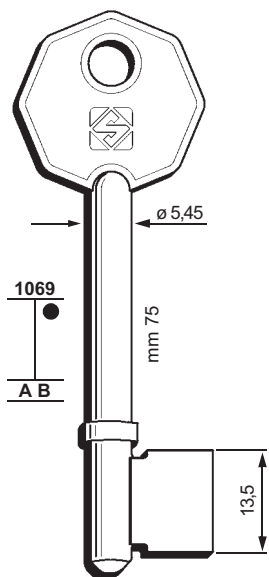

6AE1

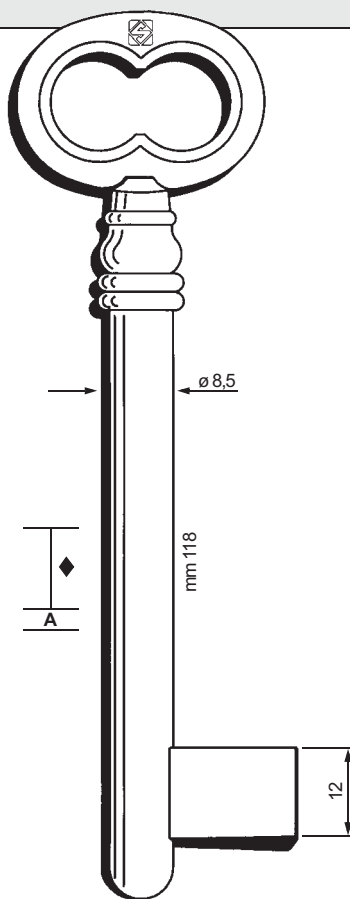

5611ALD

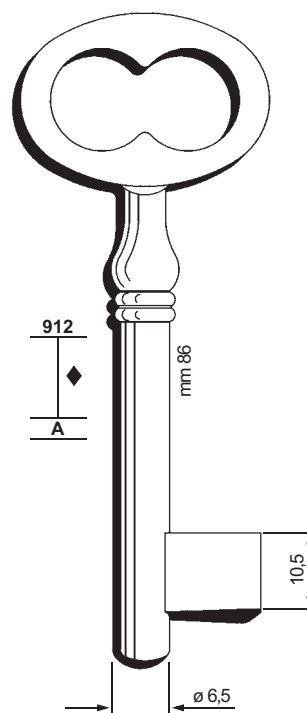

5609ALD

FOR:
PER:

ALEDAL

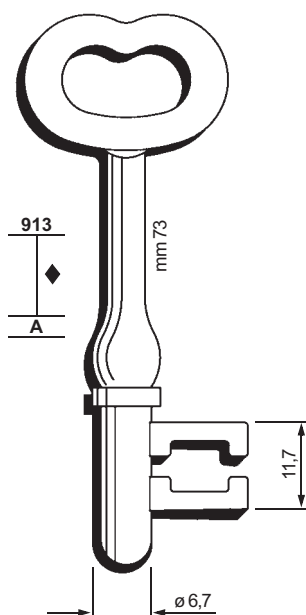

5807ALD2

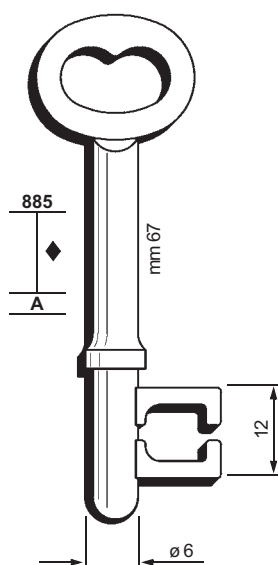

5870ALD1

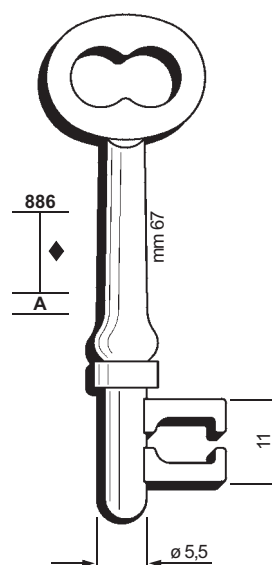

5870ALD2

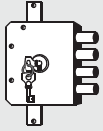

84

FOR/PER

ALEDAL (S)

ANCHOR (S)

AVA CHUBB (85)

ARCU (E)

ASSA (S)

FOR:

PER:

ALEDAL

ARCU

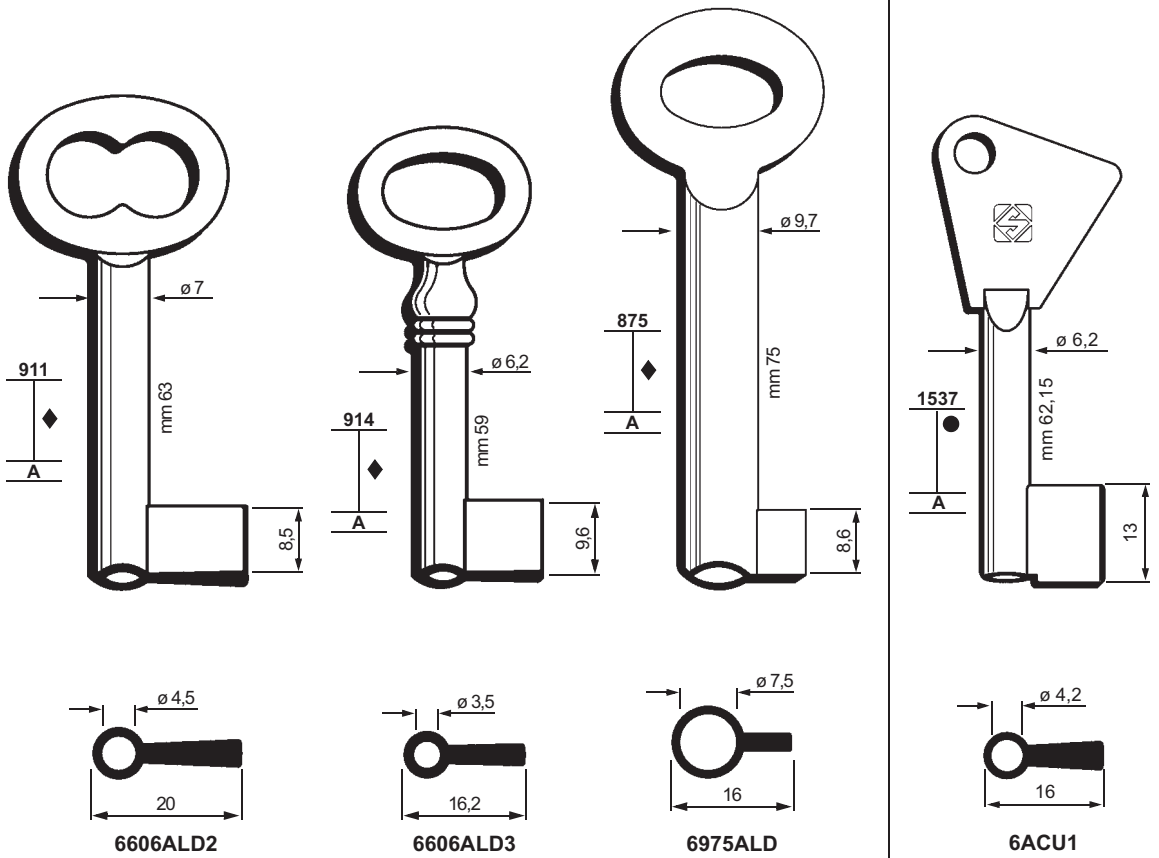

FOR:

PER:

ASSA

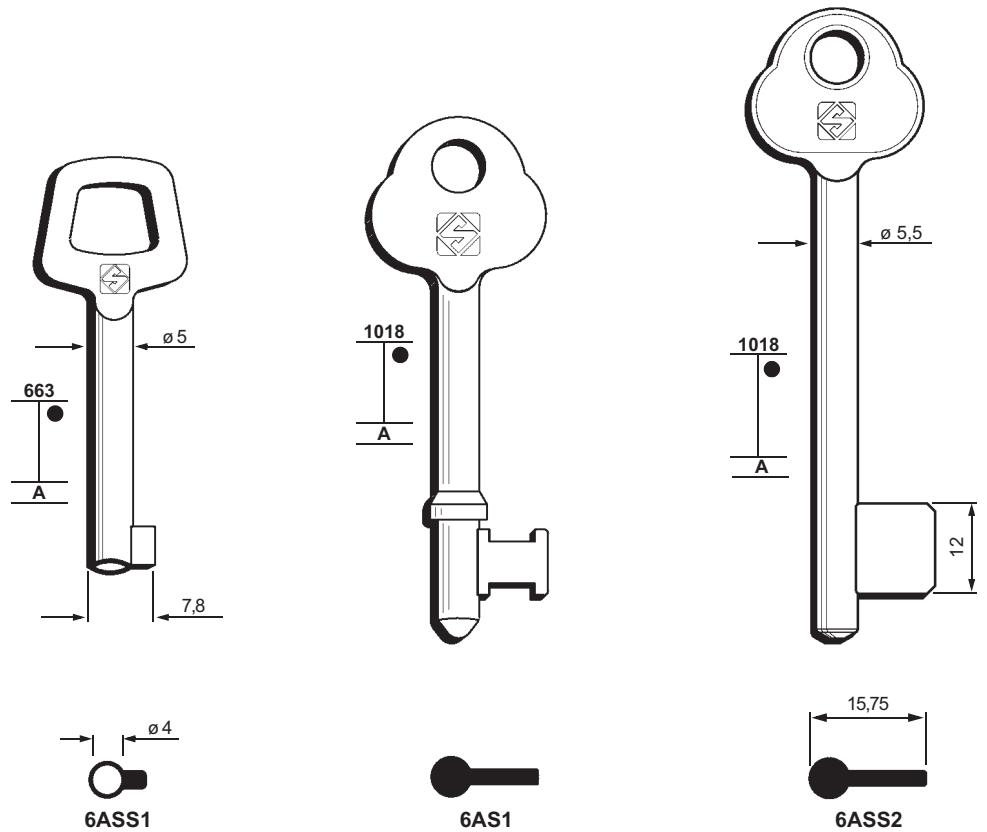

FOR:
PER:

AVA-CHUBB

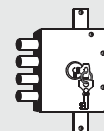

85

FOR/PER

AVA-CHUBB (S)
ANCHOR

BKS (D)

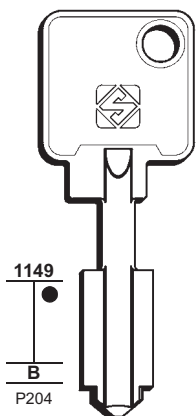

5ACH4

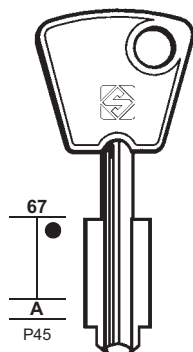

ACH

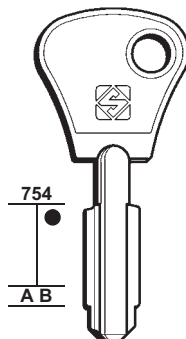

5ACH1

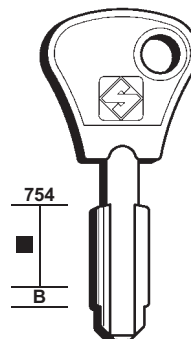

5ACH3

ANCHOR

FOR:
PER:

AVA-CHUBB

BKS

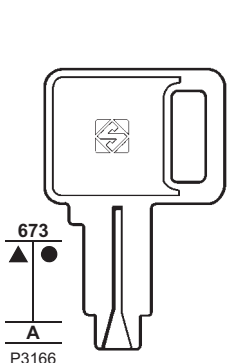

CHU5

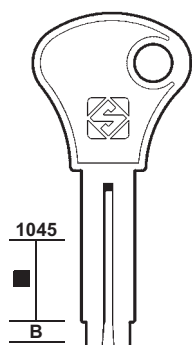

CHU7

ANCHOR

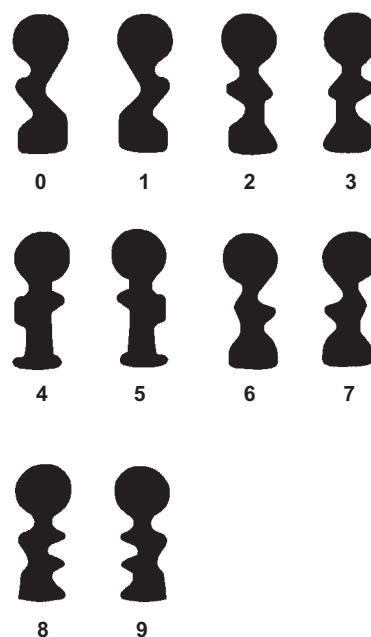
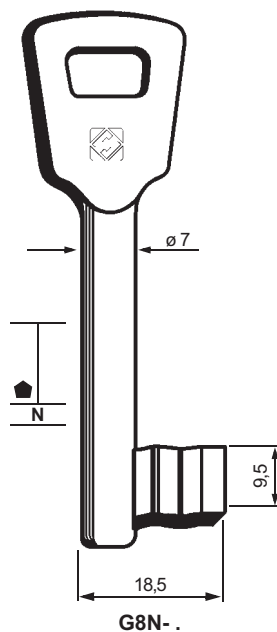

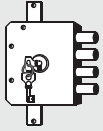

86

FOR/PER

BKS (D)

BODA (FIN)

FOR:

PER:

BKS

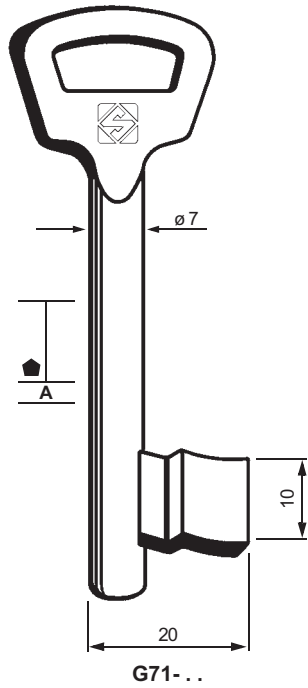

13 1/2



15 1/2



17 1/2



19 1/2



21 1/2



23 1/2



27 1/2



31 1/2

FOR:
PER:

BODA

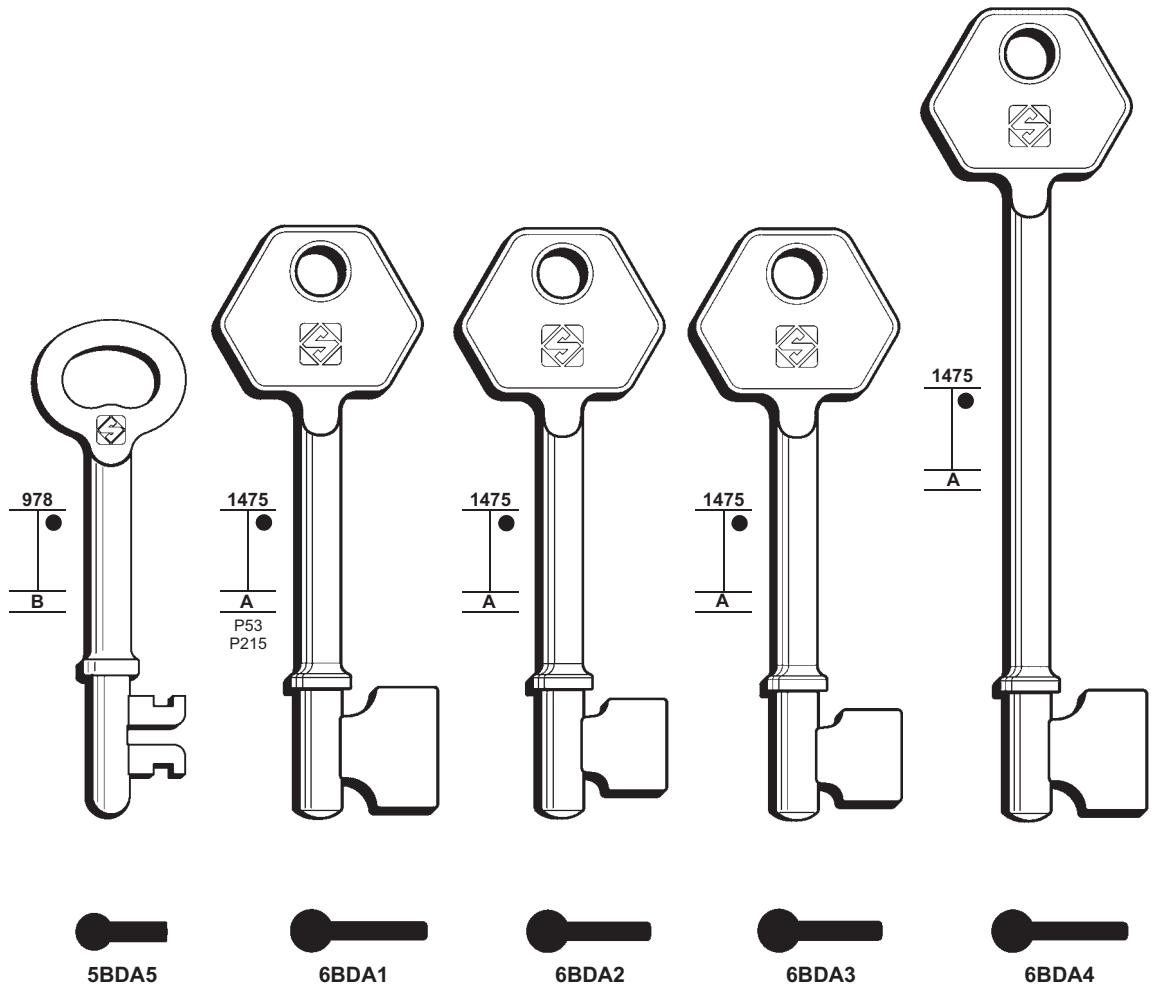

FOR:
PER:

BODE

BRANDTEK

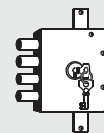

87

FOR/PER

BODE (D)
CAWI
WITTKOPP

BRANDTEK (S)

BRICARD (F)

CAWI (D)

BODE (87)

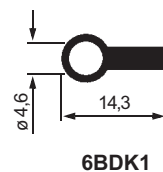
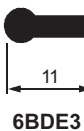
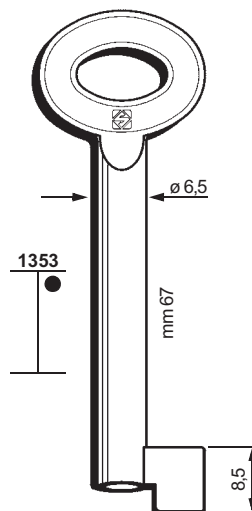
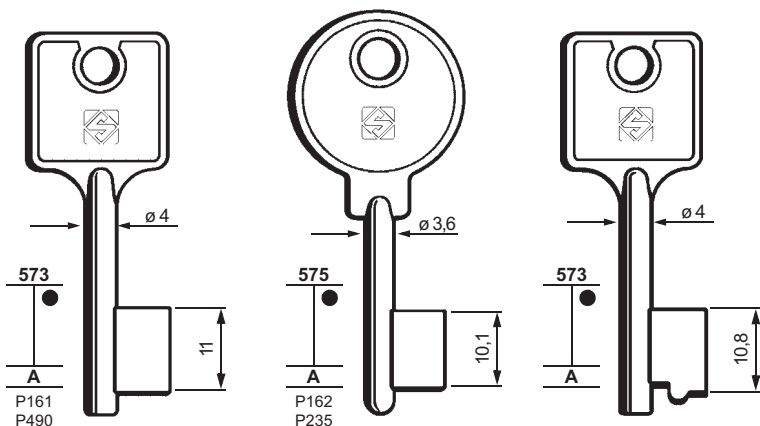

CAWI-WITTKOPP

FOR:
PER:

BRICARD

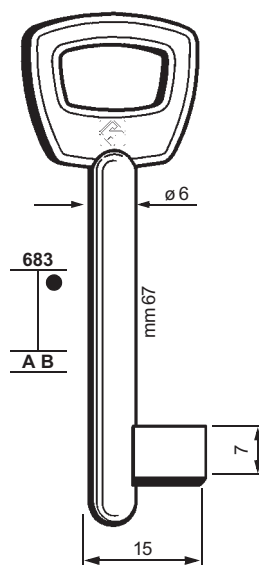
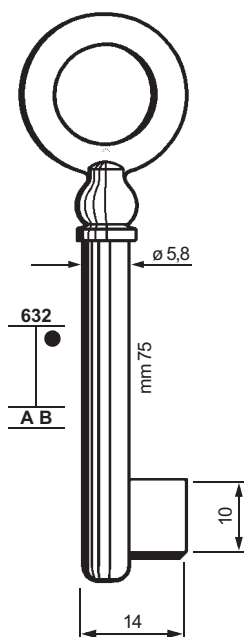
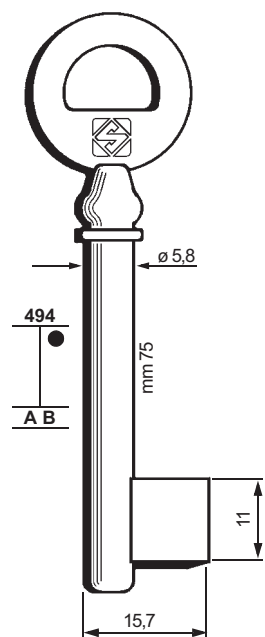

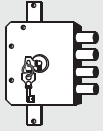

88

FOR/PER

CHUBB (GB)

CIS (I)

COUILLET (F)

CUIRASSEE (F)

FOR:

PER:

CHUBB

CIS

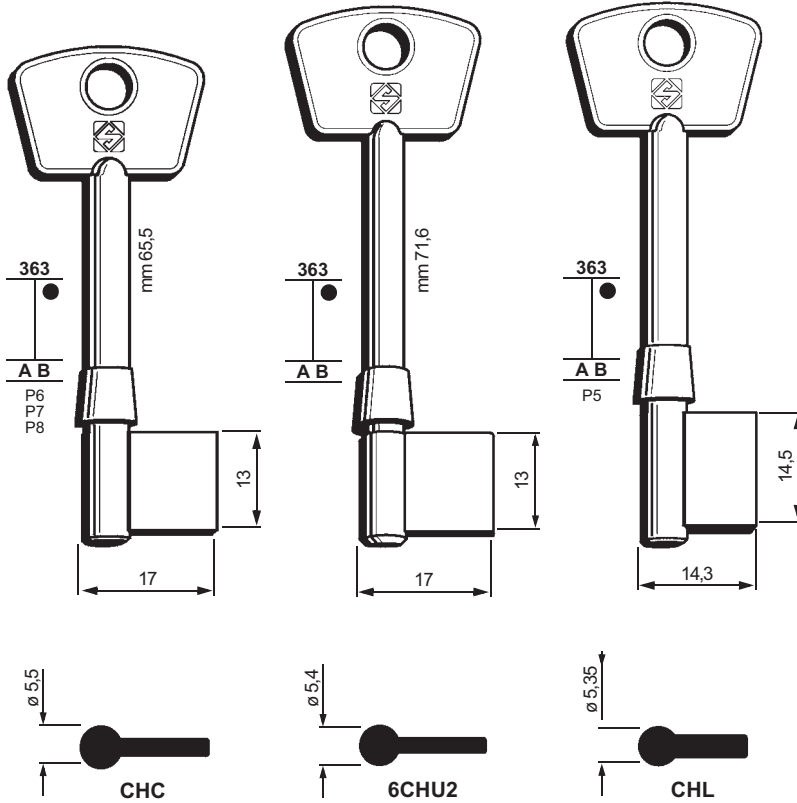

FOR:

PER:

COUILLET

CUIRASSEE

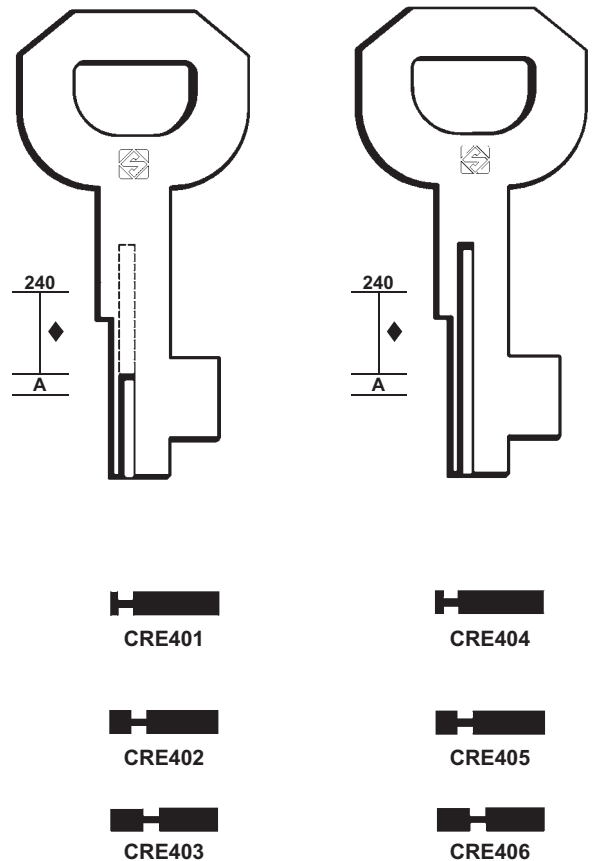
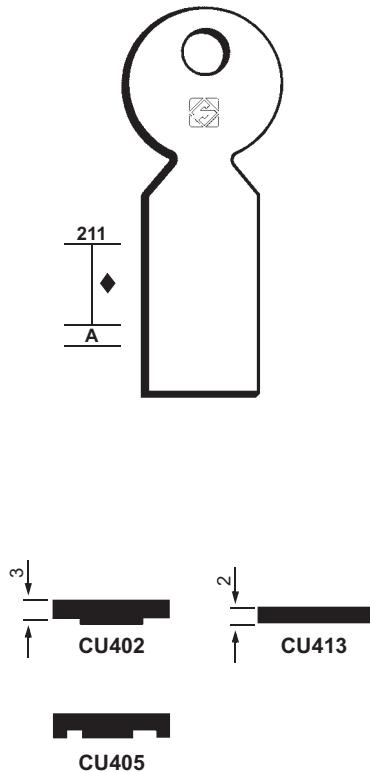

FOR: **DAD-DECAYEUX**

DEBEAURAIN

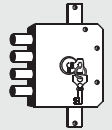

89

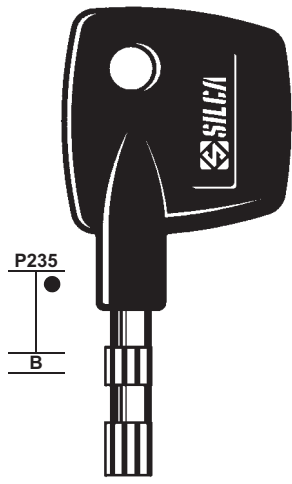

P235
B



5DD1P

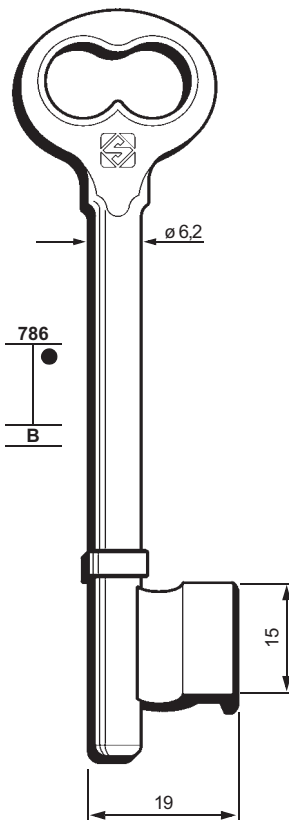

ND760LC-...



10 18 19



20 29 30

FOR/PER

DAD-DECAYEUX (F)

DEBEAURAIN (F)

FOR:
PER:

DEBEAURAIN

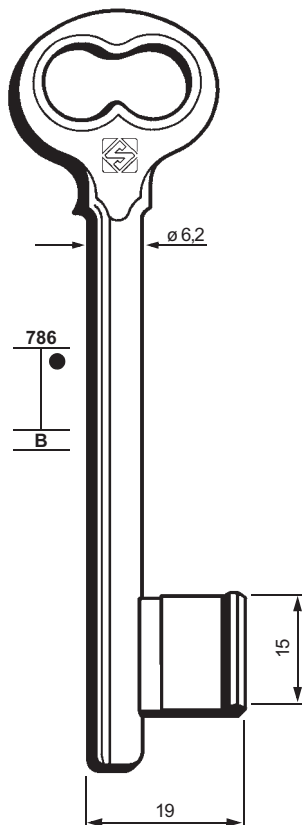

ND760L-...

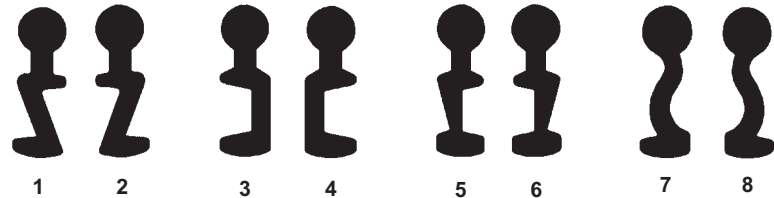

1 2 3 4 5 6 7 8

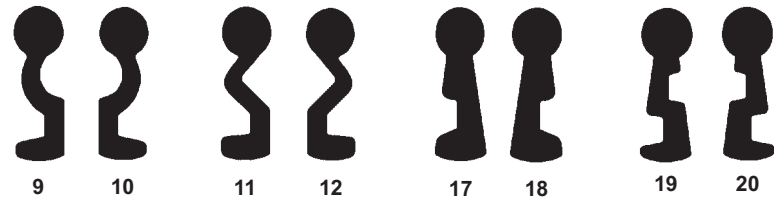

9 10 11 12 17 18 19 20

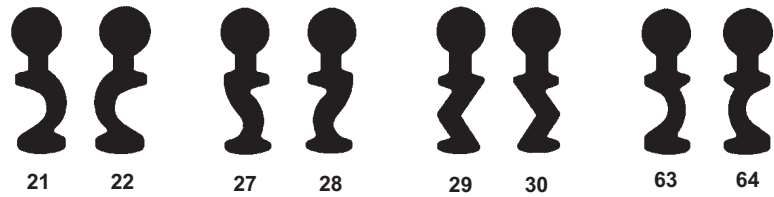

21 22 27 28 29 30 63 64

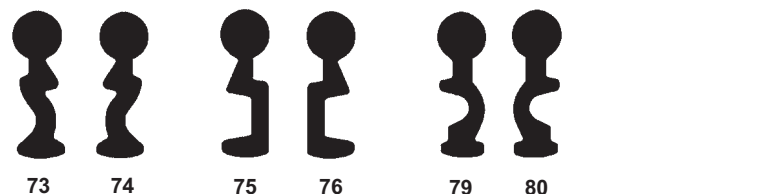

73 74 75 76 79 80

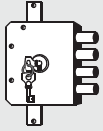

90

FOR/PER

DEBEAURAIN (F)

ELZETT (H)

EMERY (F)

ERA (GB)

FOR:
PER:

DEBEAURAIN

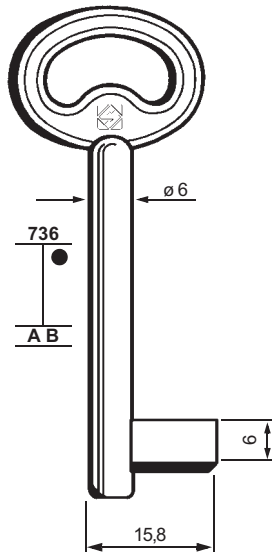

ND740L-1



ND740L-10



ND740L-4



ND740L-5



ND740L-6



ND740L-7



ND740L



ND740L-8



ND740L-9

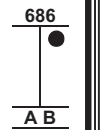
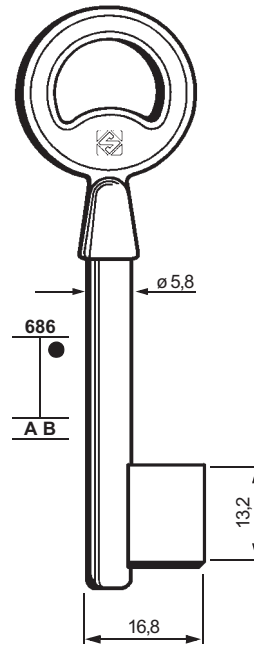

ND706L

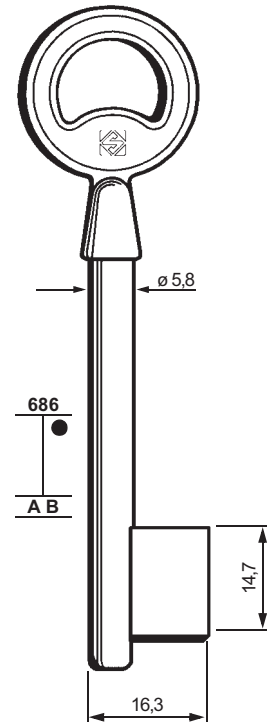

ND704L

FOR:
PER:

ELZETT

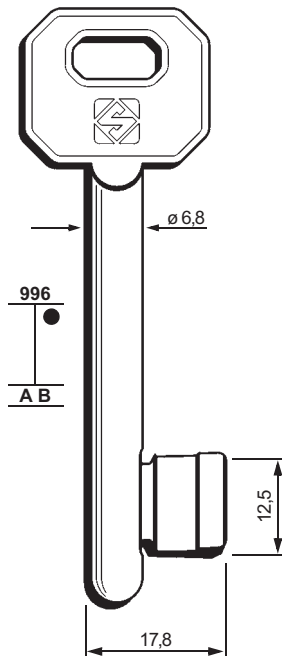

6EL2



6EL1

EMERY

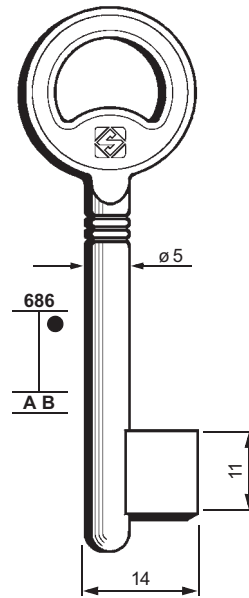

EY300

ERA

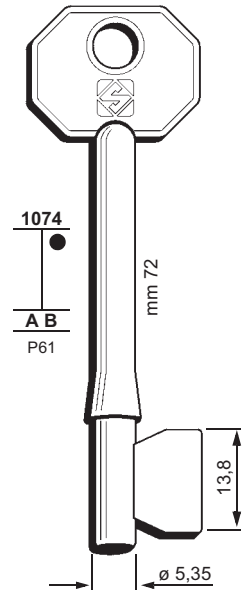

6ER1

FOR:
PER:

FICHET

FTH

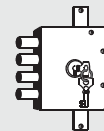
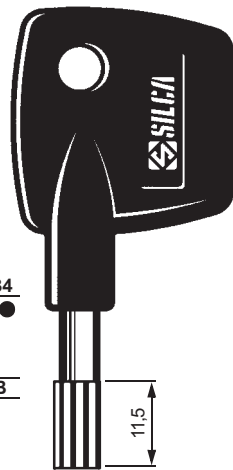
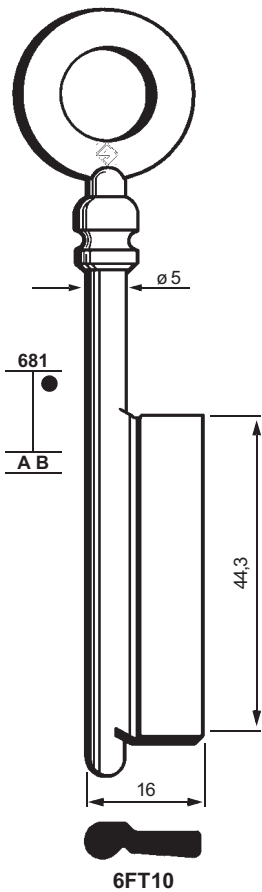
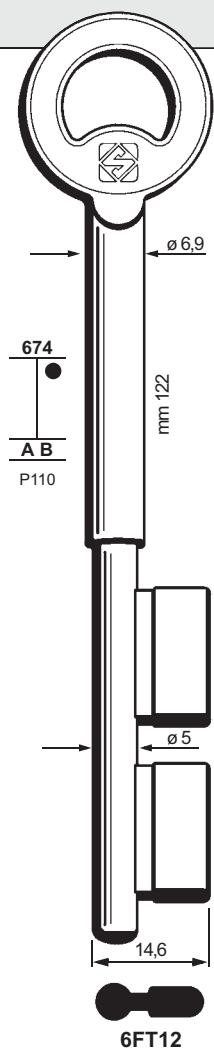

91

FOR/PER

FICHET (F)

FTH (F)

FOR:
PER:

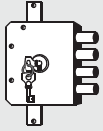

92

FOR/PER
GEGE (A)

FOR:

PER:

GEGE

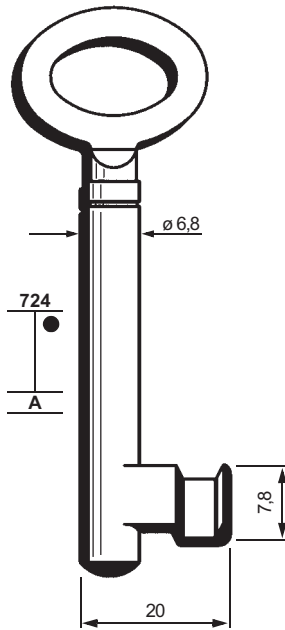

GE700-2



GE700-4



GE700-5



GE700-6



GE700-8



GE700-12



GE700-14



GE700-15



GE700-17



GE700-19



GE700-21



GE700-22



GE700-23



GE700-24



GE700-25



GE700-27



GE700-28



GE700-29



GE700-30



GE700-32



GE700-33



GE700-34



GE700-35



GE700-36



GE700-38



GE700-39



GE700-40



GE700-41



GE700-42



GE700-43



GE700-44



GE700-45



GE700-47



GE700-48



GE700-49



GE700-51



GE700-52



GE700-53



GE700-54



GE700-55



GE700-56



GE700-57



GE700-58



GE700-59



GE700-60

FOR:
PER:

GLITTENBERG

GOLLOT

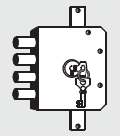

93

FOR/PER

GLITTENBERG (D)

GOLLOT (F)

GPZ (RUS)

HELASON (A)

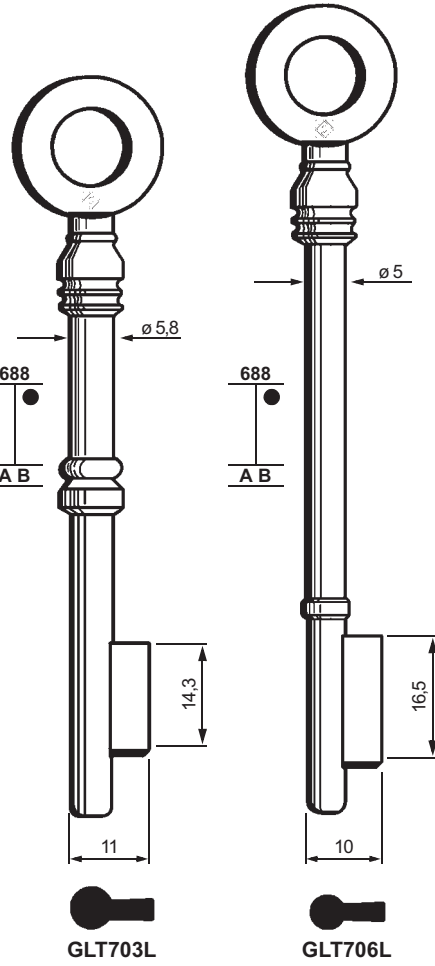
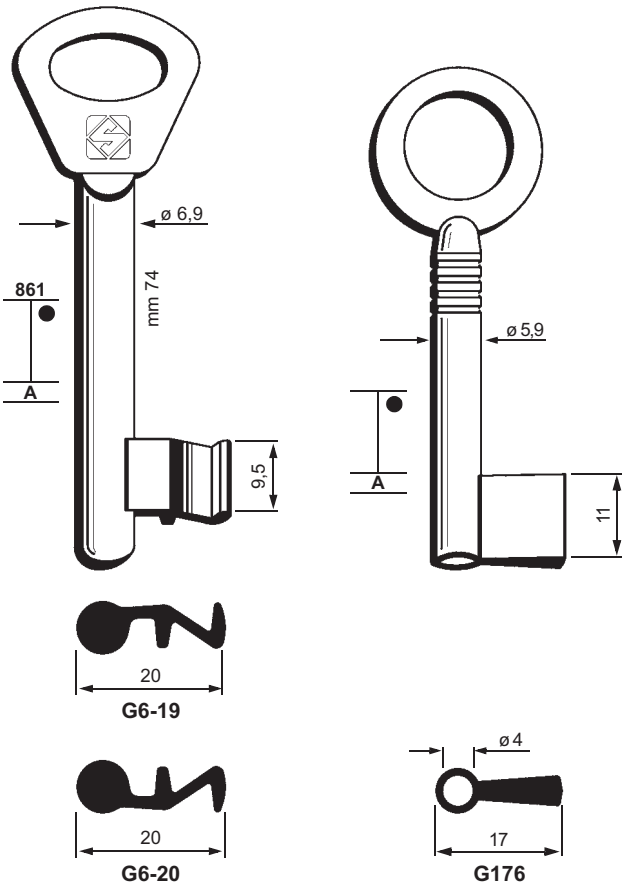

FOR:
PER:

GOLLOT

GPZ

HELASON

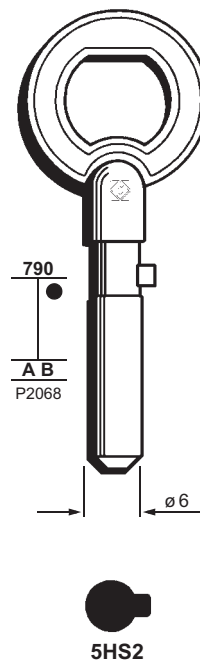
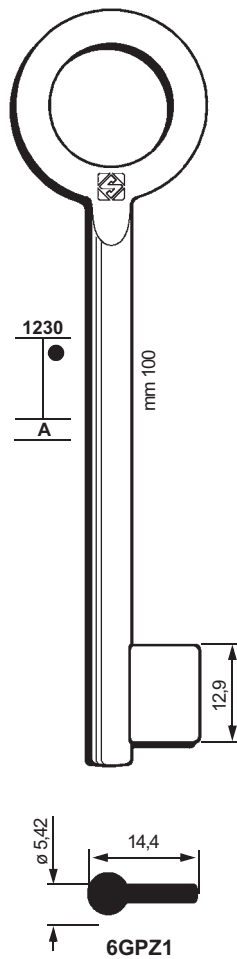
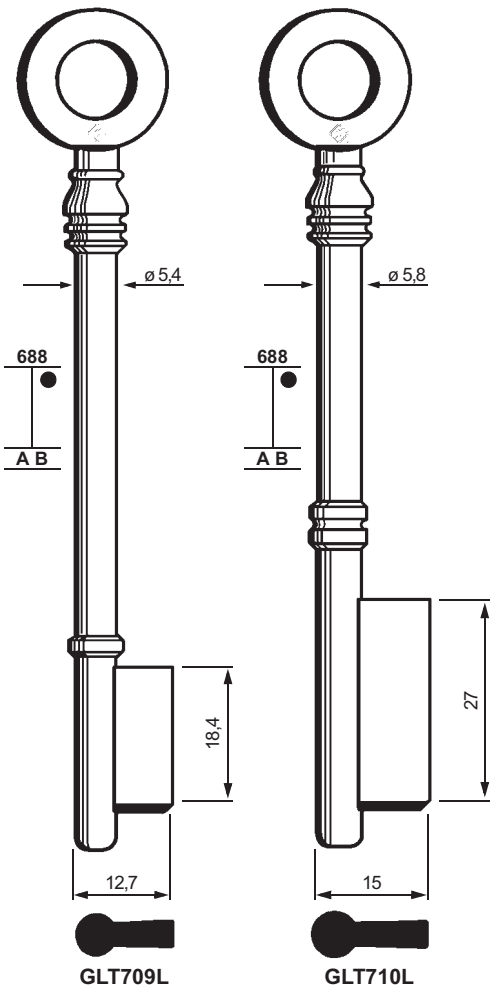

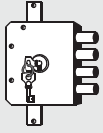

94

FOR/PER
HOBES (CZ)

FOR:

PER:

HOBES

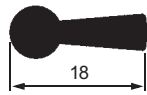
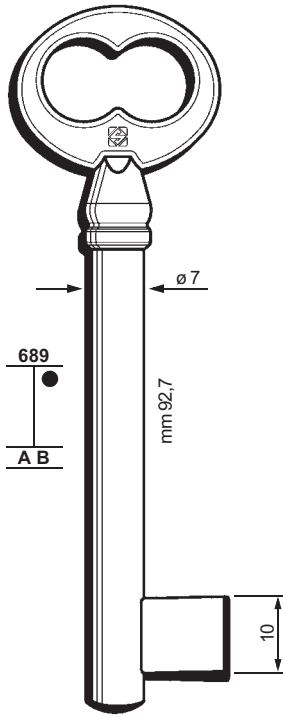

6HOB1

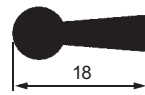
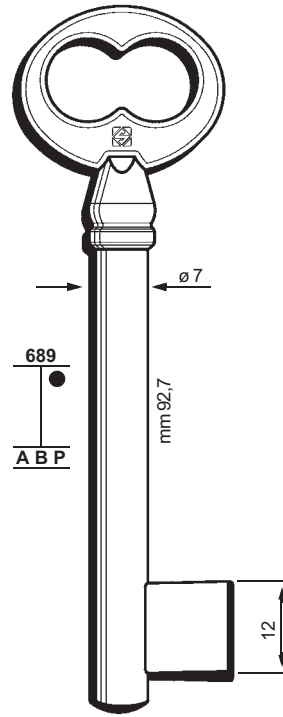

6HOB2

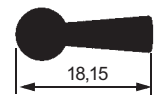
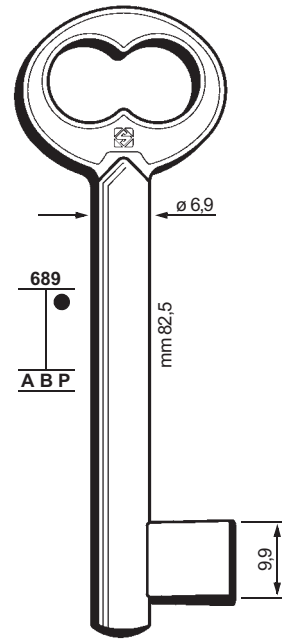

6HOB4

FOR:
PER:

HOBES

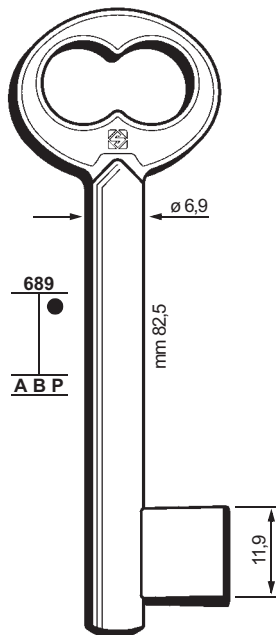

6HOB3

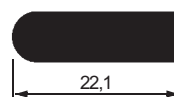
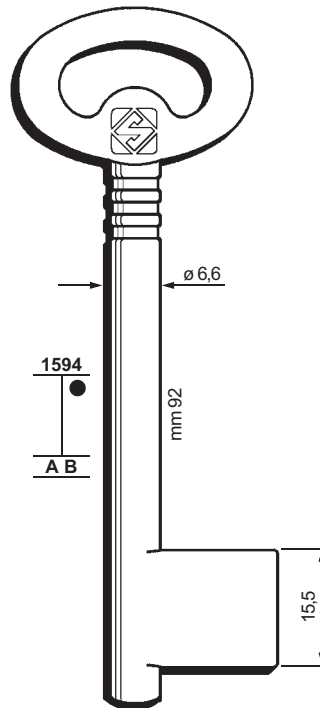

6HOB5

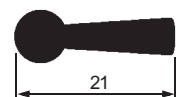
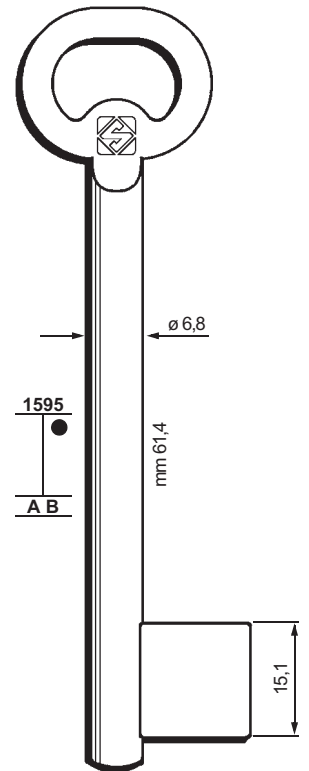

6HOB9

FOR:
PER:

HOBES

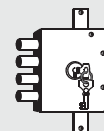

95

FOR/PER

HOBES (CZ)

JPM (F)

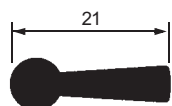
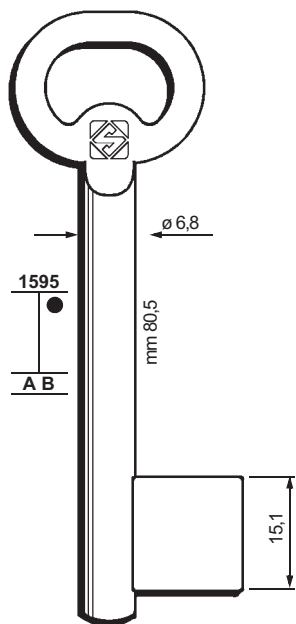

6HOB7

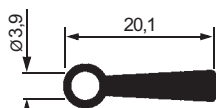
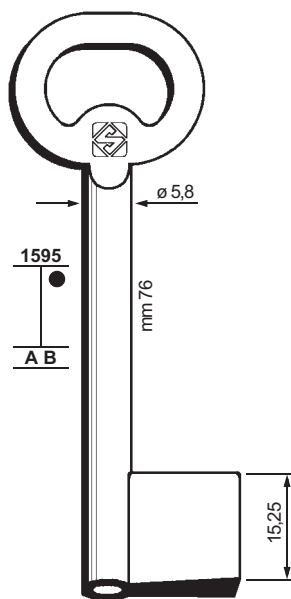

6HOB6

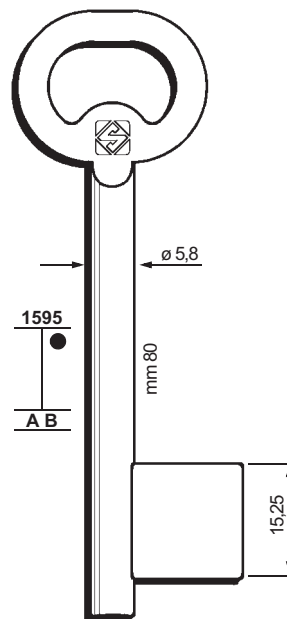

6HOB8



FOR:
PER:

JPM

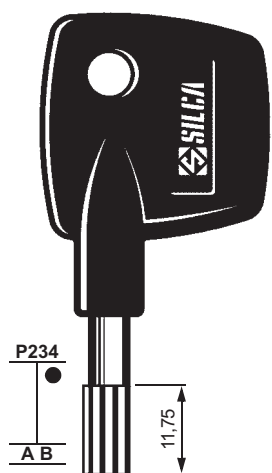

5JM1P

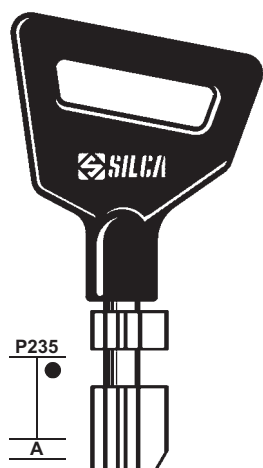

5JM2P

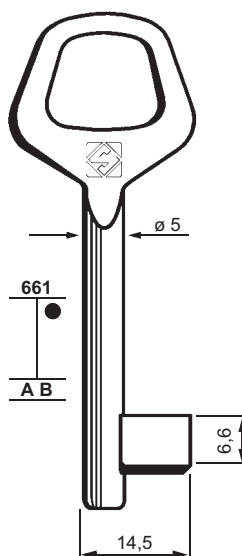

6JM1



6JM1-1



6JM1-2



6JM1-6



6JM1-7



6JM1-8



6JM1-9



6JM1-10



6JM1-11



6JM1-12

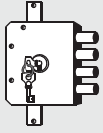

96

FOR/PER

JPM (F)

KROMA (D)

OSTERTAG (101)

FOR:
PER:

JPM

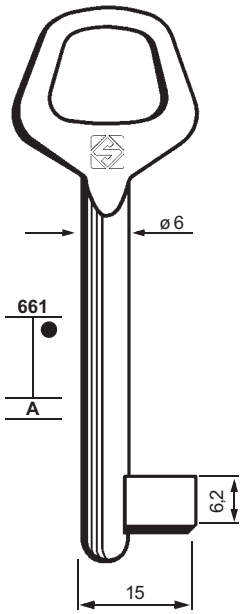

JM600L

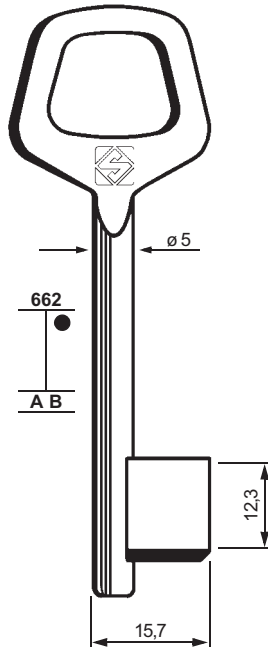

6JM2

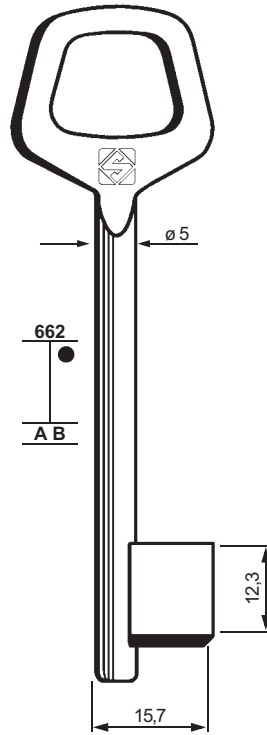

6JM3

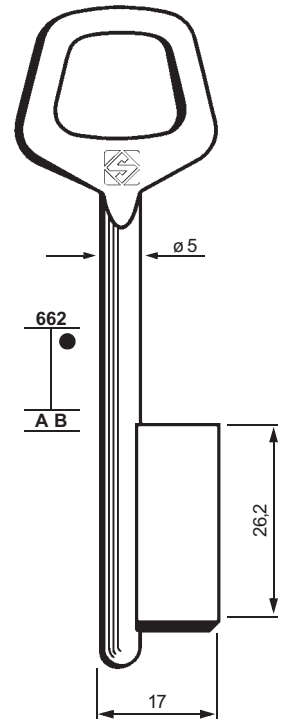

6JM4

FOR:
PER:

JPM

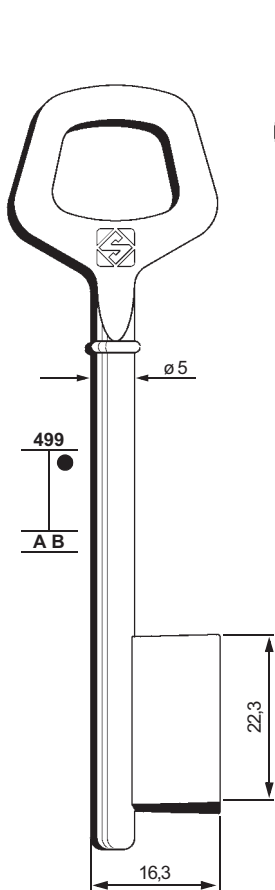

6JM5

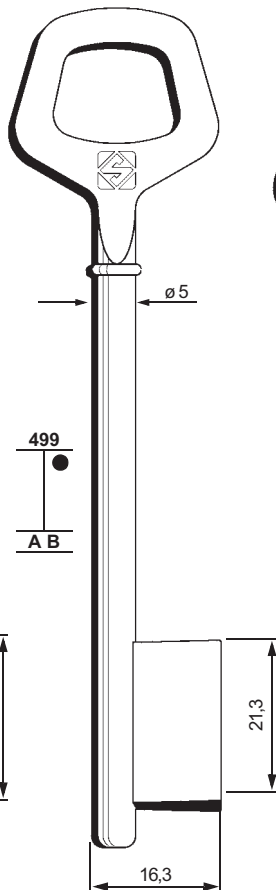

6JM6

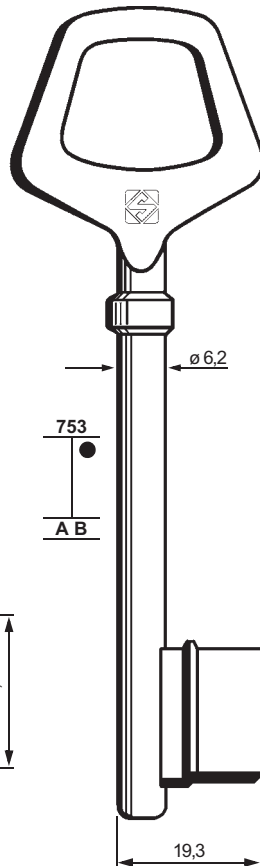

JM710L- . .

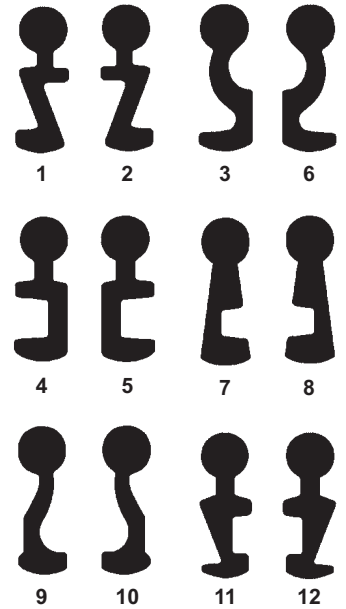

FOR:
PER: **KROMNI**

LAPERCHE

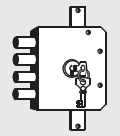

97

FOR/PER
KROMNI (WAN)
UNION
LAPERCHE (F)

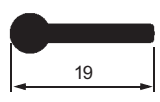
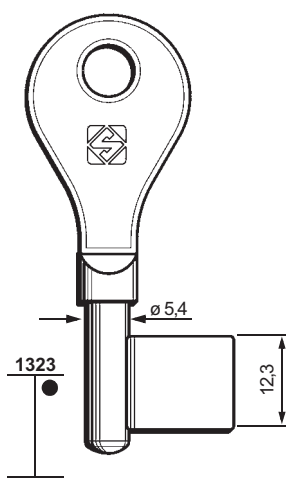

6KRN1
UNION

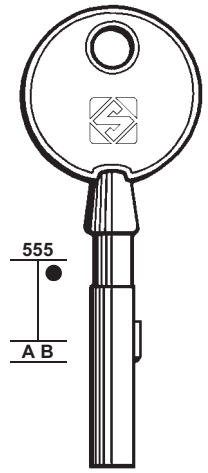

5LH1

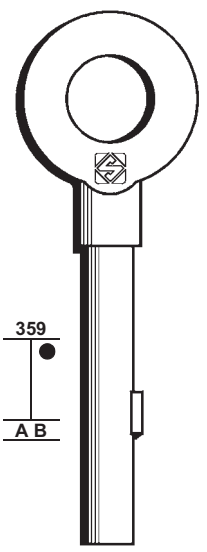

5LH3

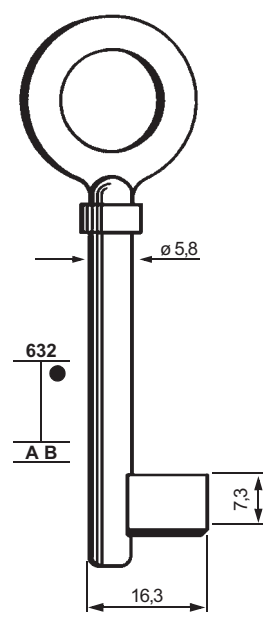

LH700

FOR:
PER: **LAPERCHE**

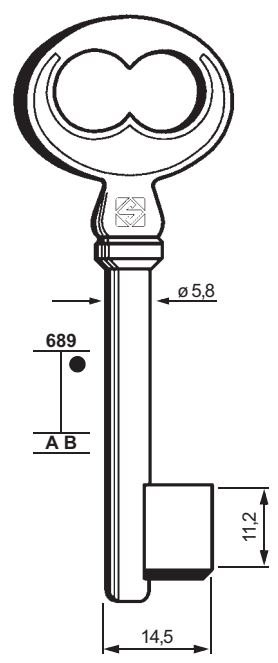

LH701

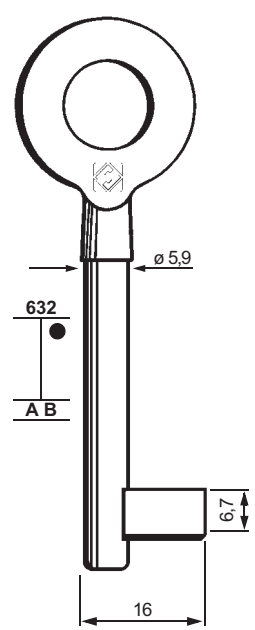

LH710L



LH710L-3



LH710L-4



LH710L-5



LH710L-6



LH710L-9



LH710L-10

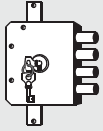

98

FOR/PER

LAPP-FINZE (A)

LAUDON (GB)

LINCE (E)

LOWE & FLETCHER (GB)

MAFOR (F)

FOR:
PER:

LAPP-FINZE

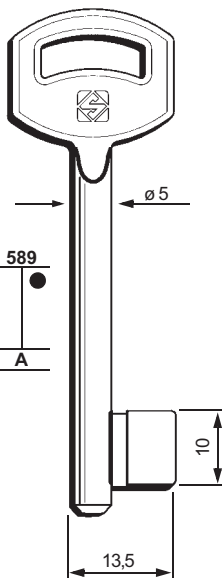

6LZ1

6LZ2



6LZ3

6LZ4

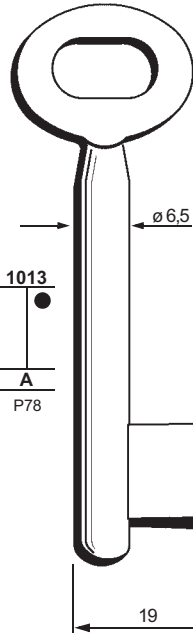

6LZ5



6LZ5-1



6LZ5-2



6LZ5-3



6LZ5-4



6LZ5-5



6LZ5-6

LAUDON

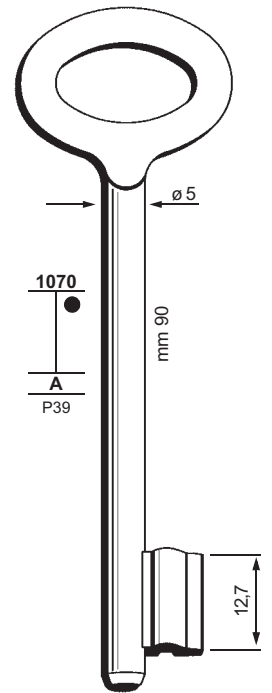

6LDN1

FOR:
PER:

LINCE

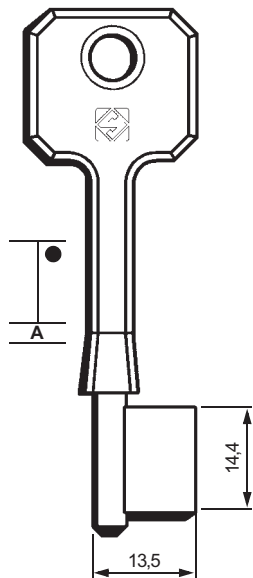

LC

LOWE & FLETCHER

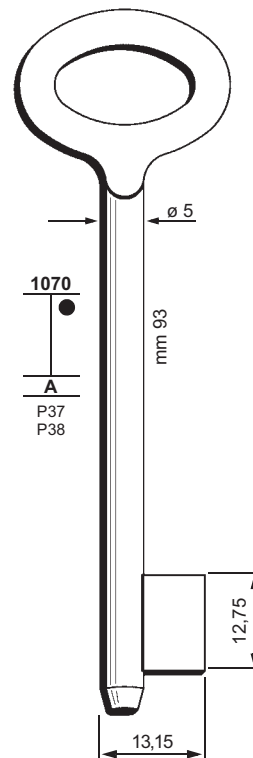

6LW2

MAFOR

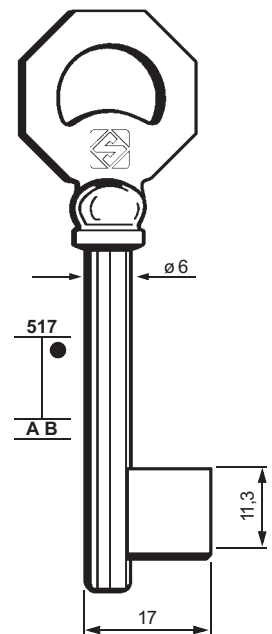

6MF1

FOR: **MARSTON**

MOBELLA

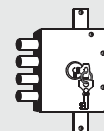

99

FOR/PER

MARSTON (GB)

MOBELLA (S)

MUEL (F)

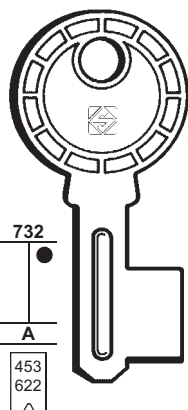
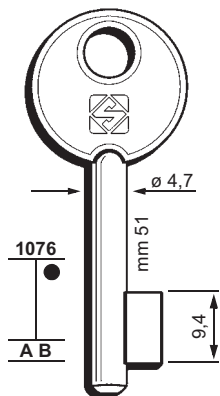

MBS300

- (SER11) 22001-22750
- (SER12) 17501-18250
- (SER13) 16001-16750
- (SER14) 18251-19000
- (SER15) 16751-17500
- (SER21) 11501-12250
- (SER22) 24251-25000
- (SER23) 10751-11500
- (SER24) 12251-13000
- (SER25) 10001-10750
- 1-2-3-4-5
- 1-2-3-4-5

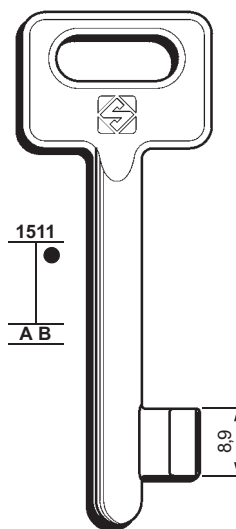
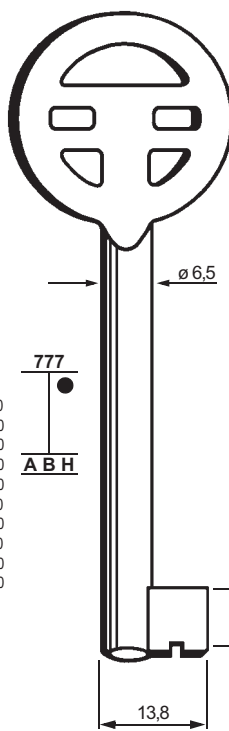

MBS301

- (SER11) 40751-41500
- (SER12) 36251-37000
- (SER13) 34751-35500
- (SER14) 37001-37750
- (SER15) 35501-36250
- (SER21) 30251-31000
- (SER22) 43001-43750
- (SER23) 29501-30250
- (SER24) 31001-31750
- (SER25) 28751-29500
- 1-2-3-4-5
- 1-2-3-4-5

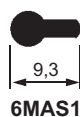
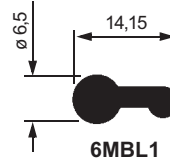
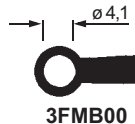

FOR:
PER:

MUEL

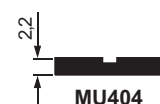
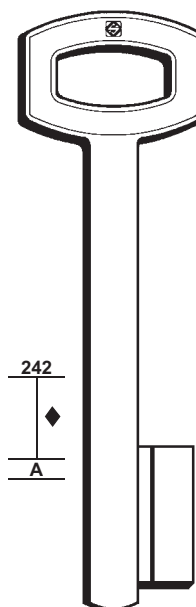
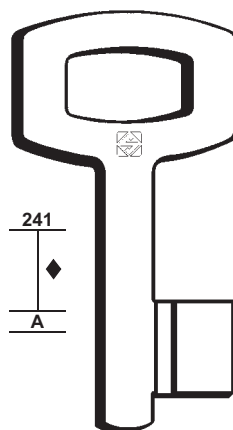
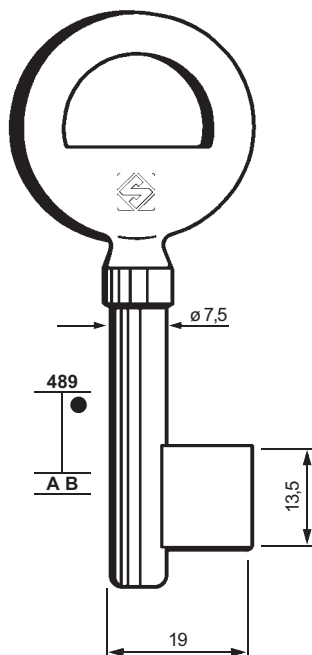

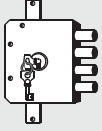

100

FOR/PER

NEMEF (NL)
V.S.B.

FOR:
PER:

NEMEF

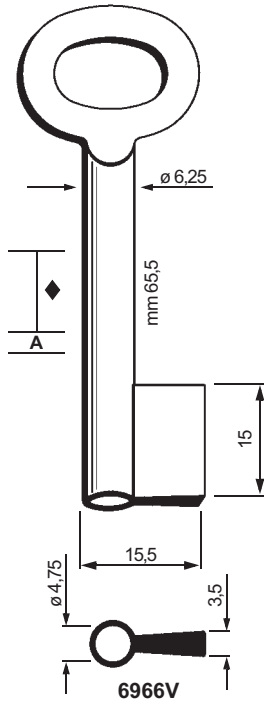

V.S.B.

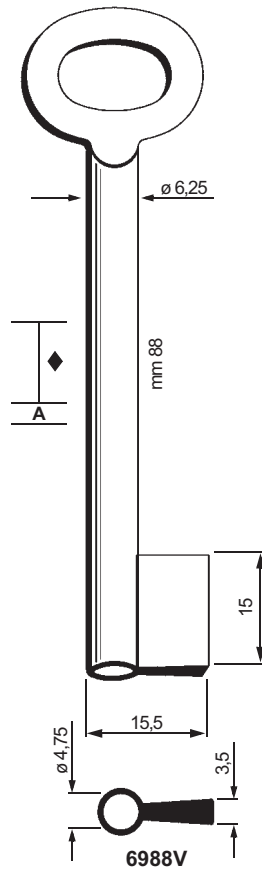

6988V

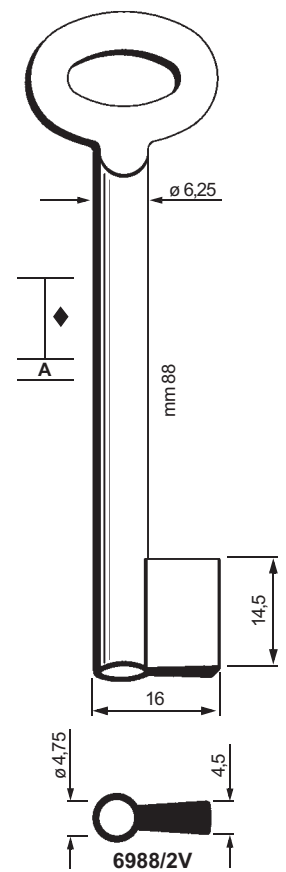

V.S.B.

FOR:
PER:

NEMEF

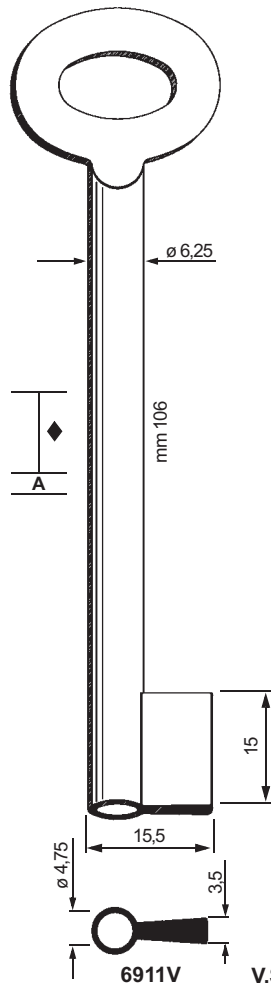

6911V

V.S.B.

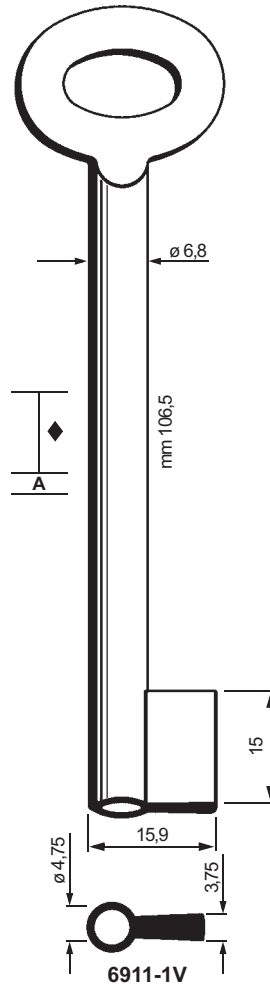

6911-1V

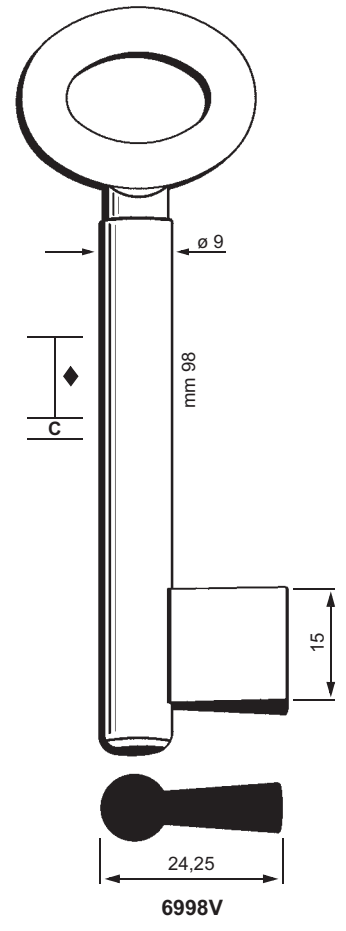

6998V

FOR:
PER:

NEMEF

ORENGO

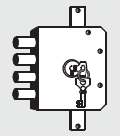

101

FOR/PER

NEMEF (NL)

ORENGO (E)

OSTERTAG (D)
KROMA

PANZER (RA)

PATENT (I)

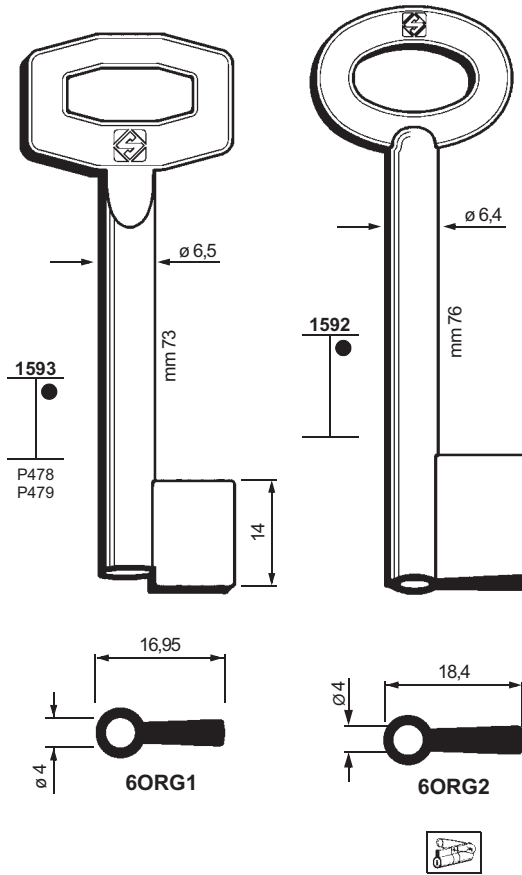
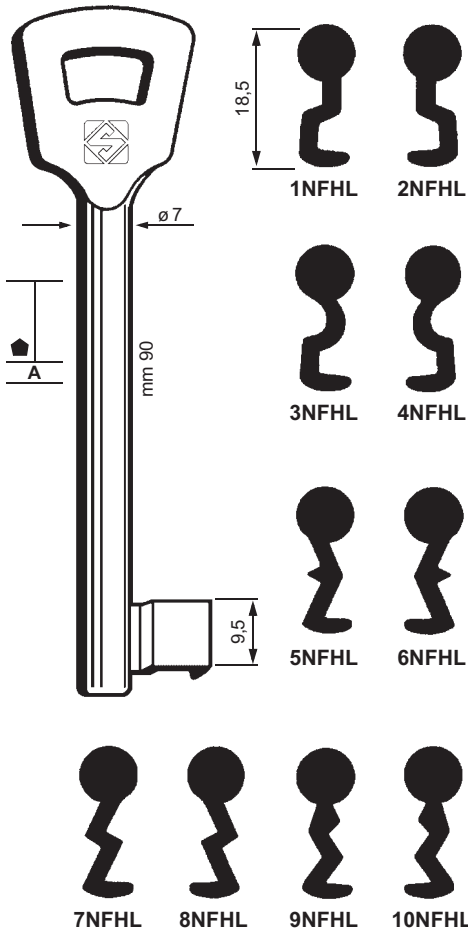

FOR:
PER:

OSTERTAG

PATENT

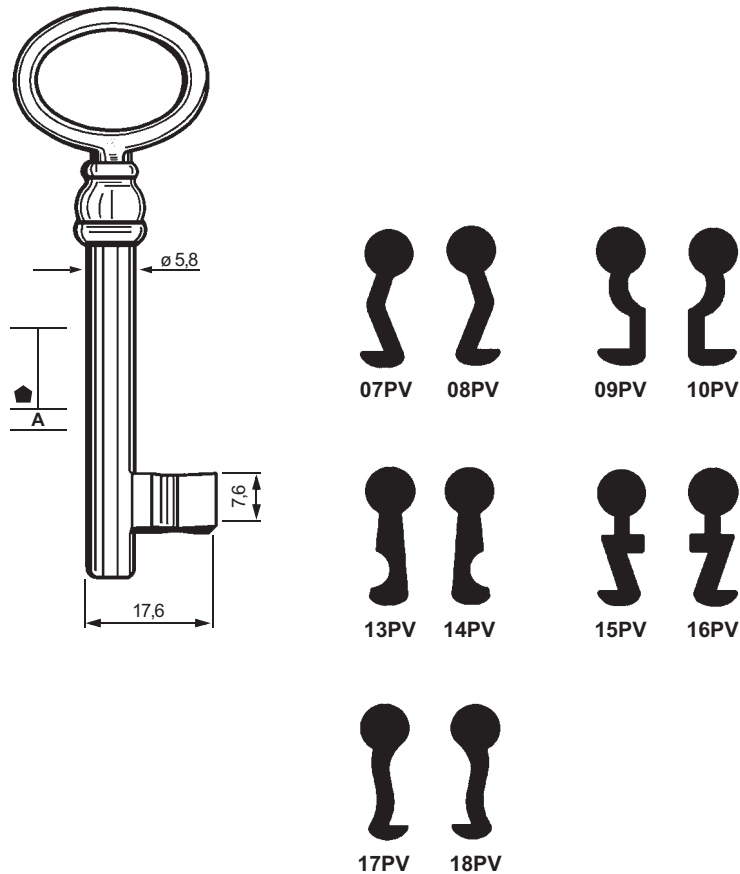
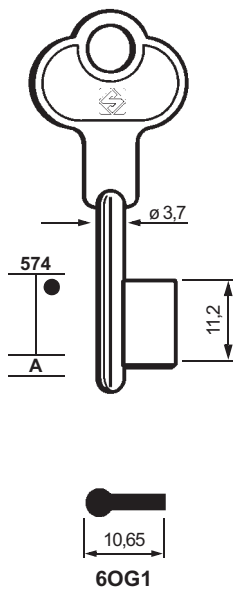

KROMA

OLD TYPE / TIPO VECCHIO

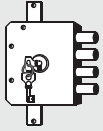

102

FOR/PER
 PICARDIE (F)
 POLLUX (F)
 PROGRES
 FONTAINE (F)

FOR:
PER:

PICARDIE

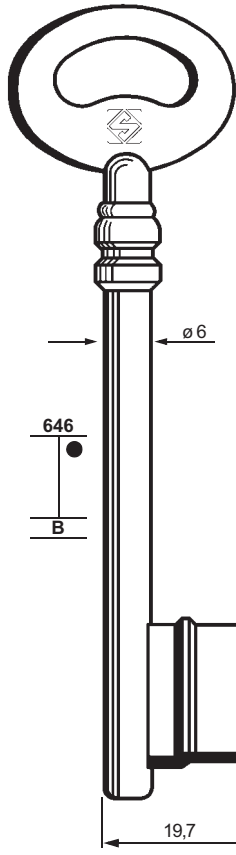

PIC710L- . .

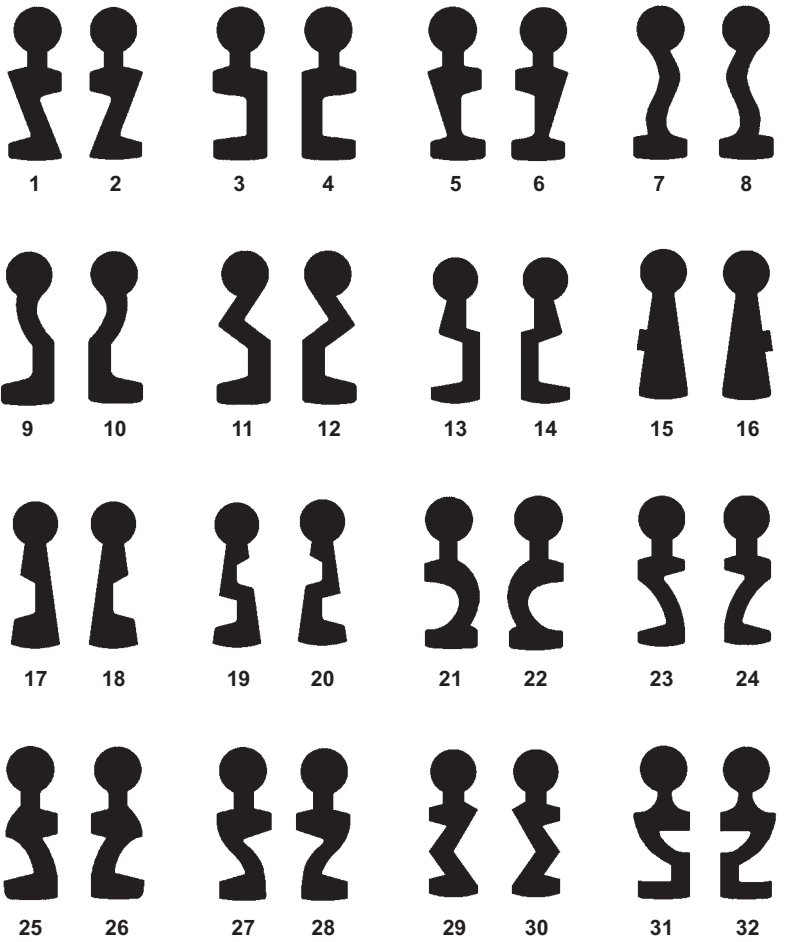

FOR:
PER:

POLLUX

PROGRES FONTAINE

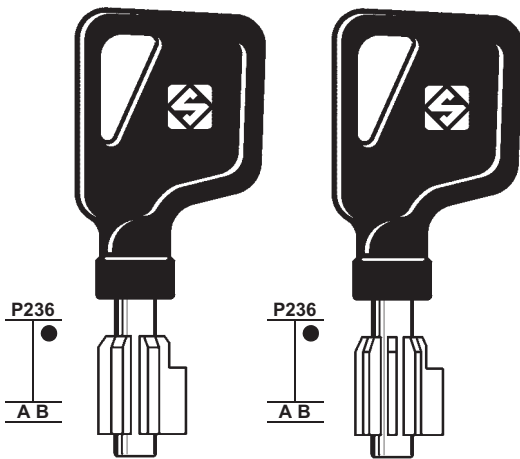

5PX1P



5PX6P



5PX2P

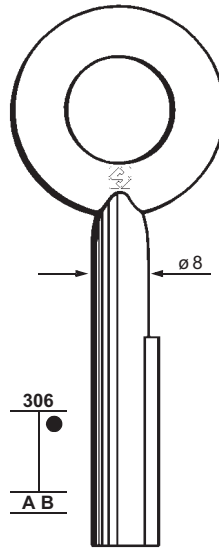

5PE1

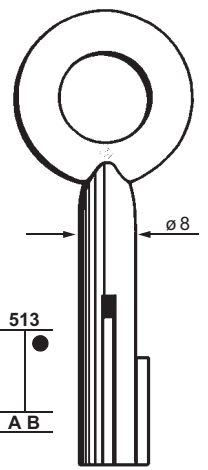

5PE2



5PE3



5PE4



5PE5

FOR:
PER: **REFORM**

RUBIS

STUV

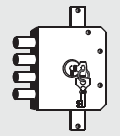

103

FOR/PER

REFORM (A)

RUBIS (F)

RUSSIA (RUS)

SELECT (F)

STUV (D)

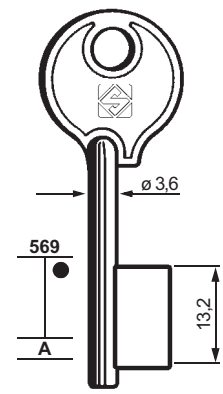
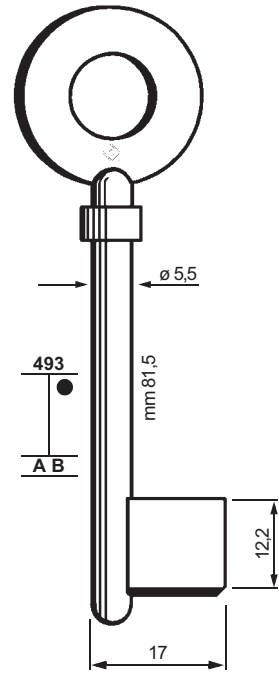
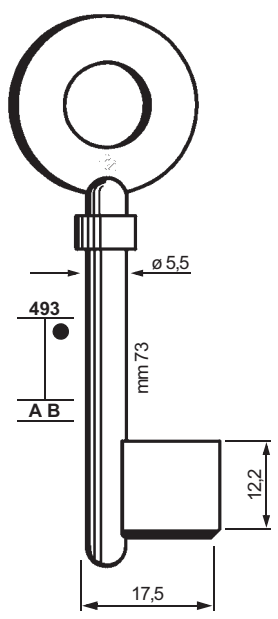
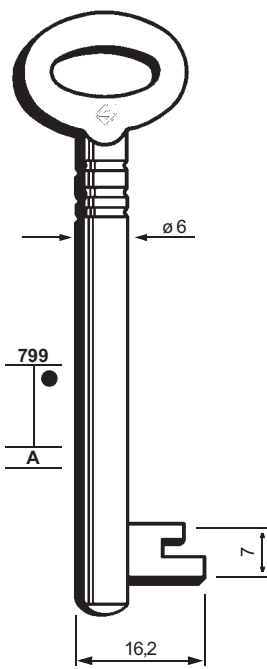

RF700



RS602



RS603



RS616



RS617

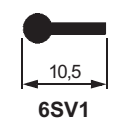

6SV1



RS604



RS601



RS615

FOR:
PER: **RUSSIA**

SELECT

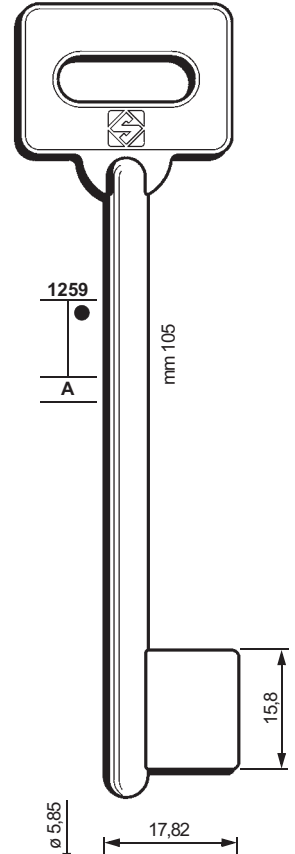

6RUS1

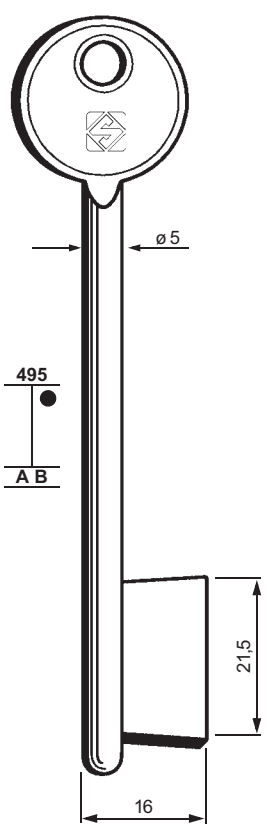

6SE1

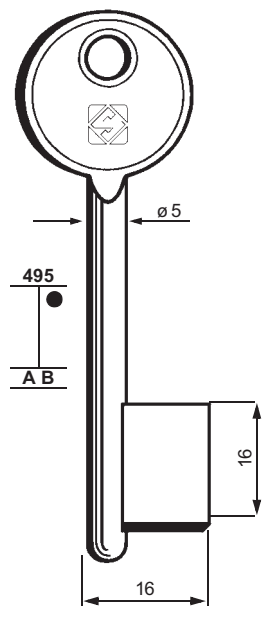

6SE2

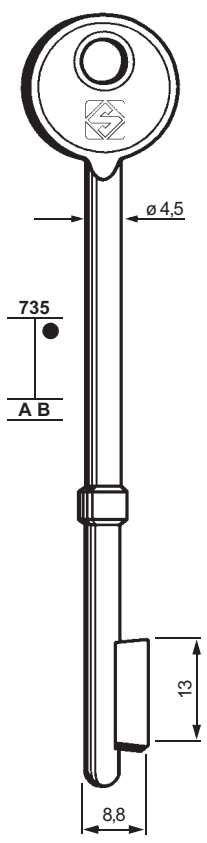

6SE3

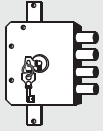

104

FOR/PER

SPERRZEUGE (D)

FOR:
PER:

SPERRZEUGE

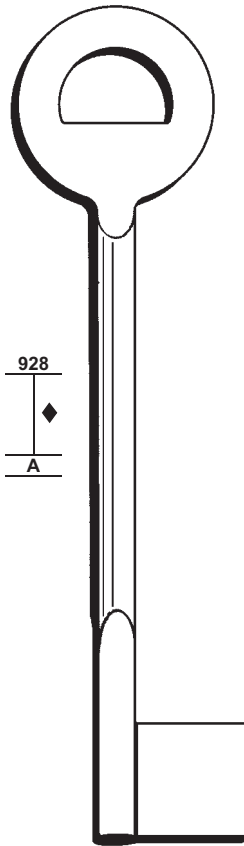

9911S



9911S-K1

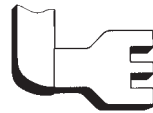

9911S-K2



9911S-K3

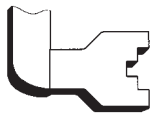

9911S-K4

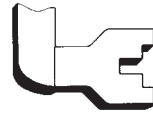

9911S-K5

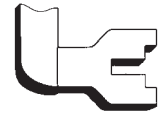

9911S-K6

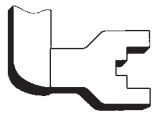

9911S-K7

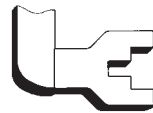

9911S-K8

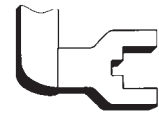

9911S-K9



9911S-K10



9911S-K11

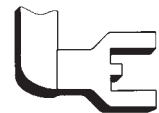

9911S-K12

FOR:
PER:

SPERRZEUGE

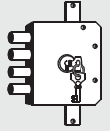

105

FOR/PER

SPERRZEUGE (D)

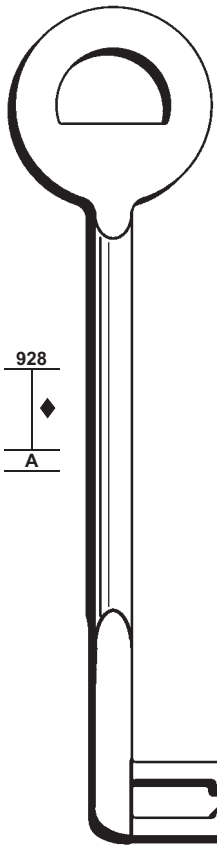

928
A

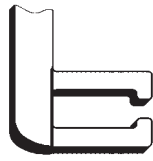

9911S-01

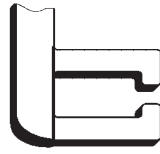

9911S-02

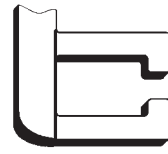

9911S-03

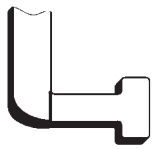

9911S-04

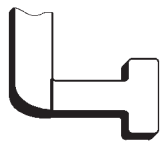

9911S-05

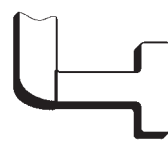

9911S-06

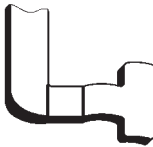

9911S-07



9911S-08

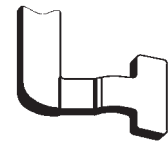

9911S-09

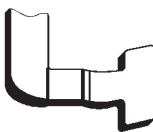

9911S-10



9911S-11



9911S-12

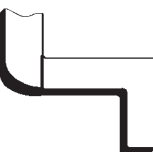

9911S-13



9911S-14

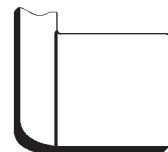

9911S-15



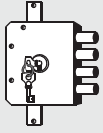

106

FOR/PER

TRIOVING (N)

UNION (GB)

+ KROMNI (97)

FOR:

PER:

TRIOVING

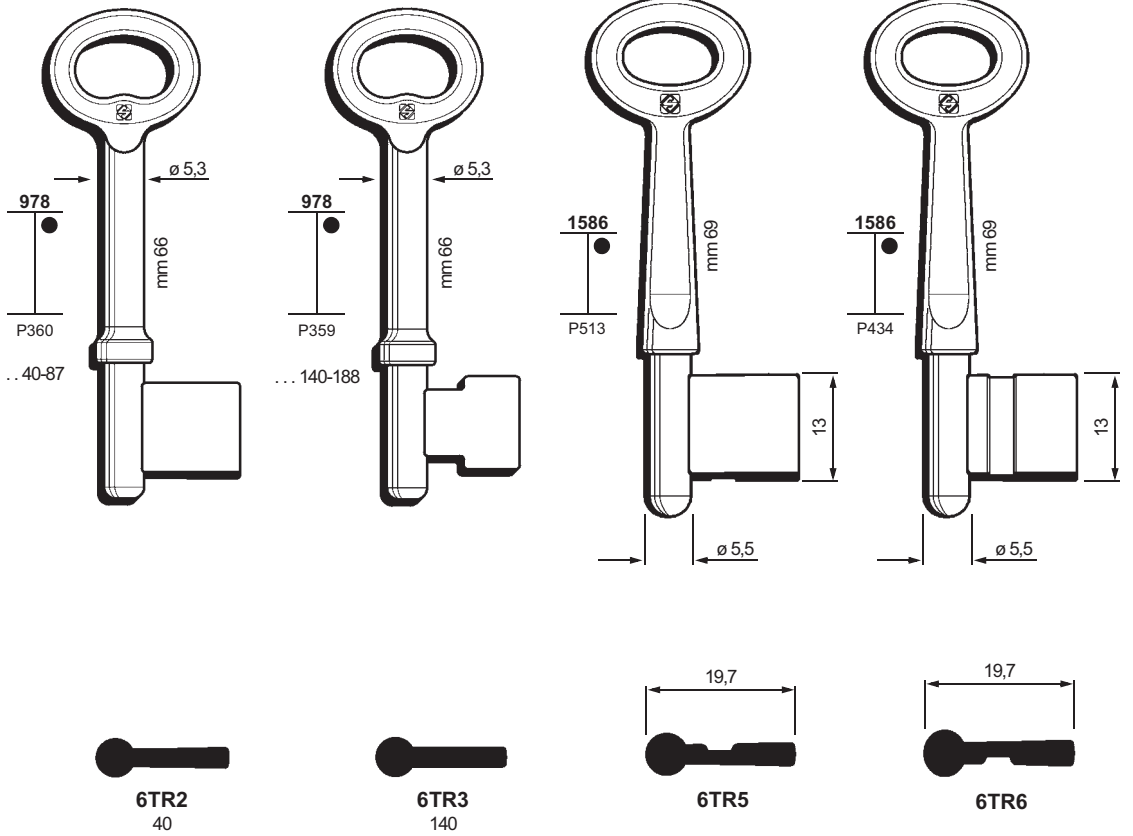

FOR:

PER:

TRIOVING

UNION

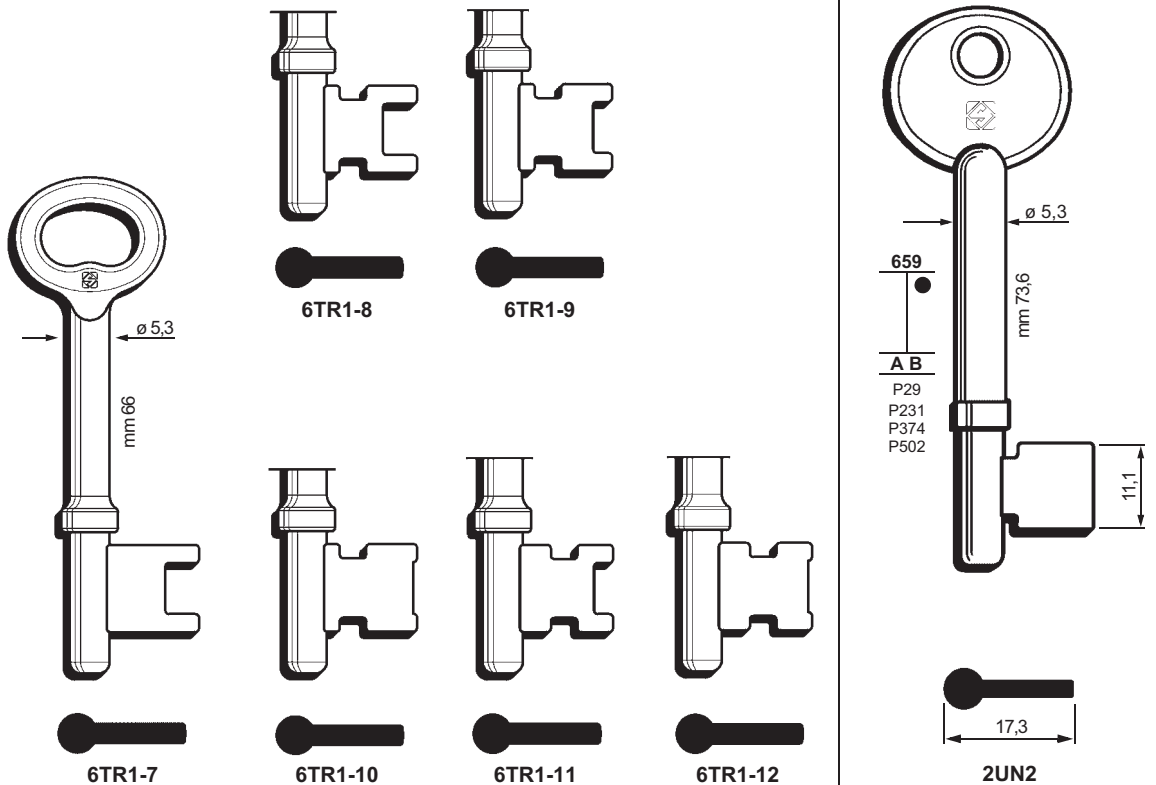

FOR:
PER:

UNION

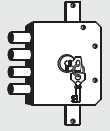

107

FOR/PER

UNION (GB)

+ KROMNI (97)

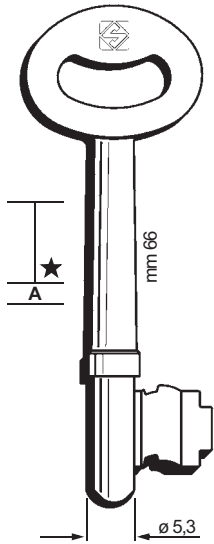

- M26H
- M32H
- M14H
- M20H

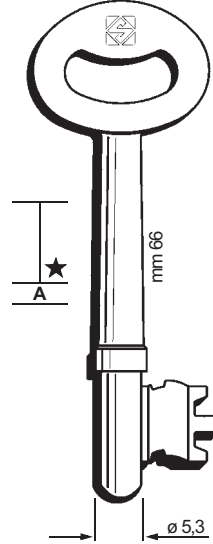

- M25H
- M31H
- M13H

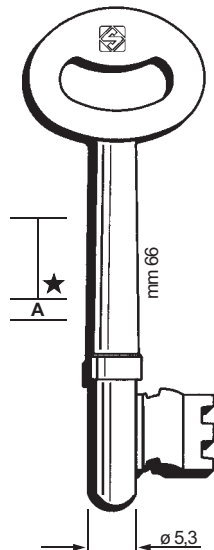

- M21H
- M27H
- M9H
- M15H
- M37H
- M33H

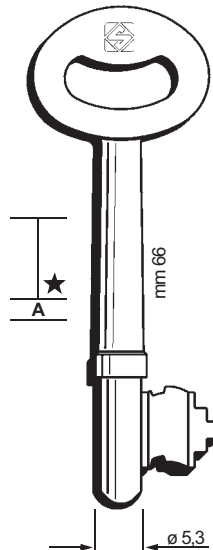

- M22H
- M28H
- M10H
- M16H
- M38H
- M34H

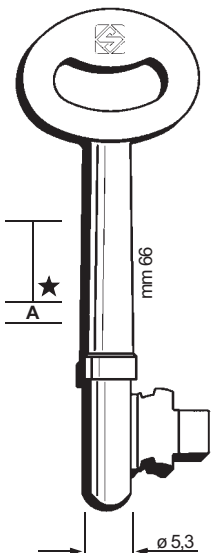

- M23H
- M29H
- M39H
- M35H

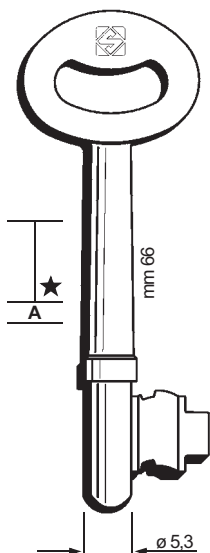

- M24H
- M30H
- M12H
- M18H
- M40H
- M36H

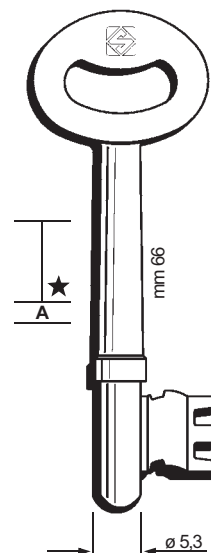

- M17H
- M11H

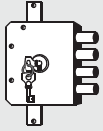

108

FOR/PER
VACHETTE (F)

FOR:
PER:

VACHETTE

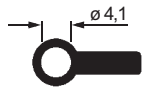
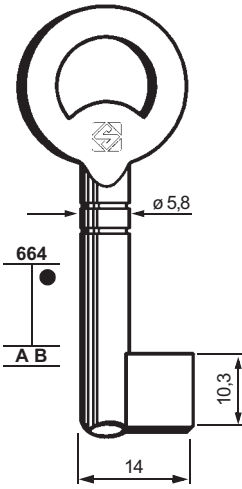

VAC304

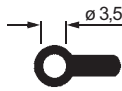
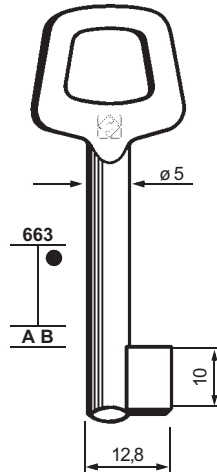

VAC303

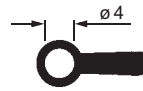
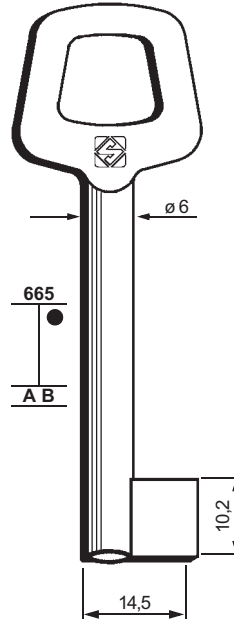

VAC305

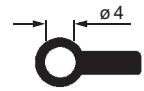
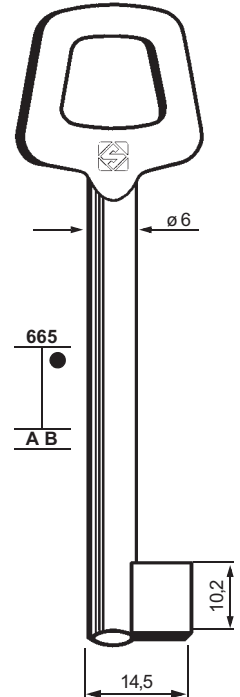

VAC306

FOR:
PER:

VACHETTE

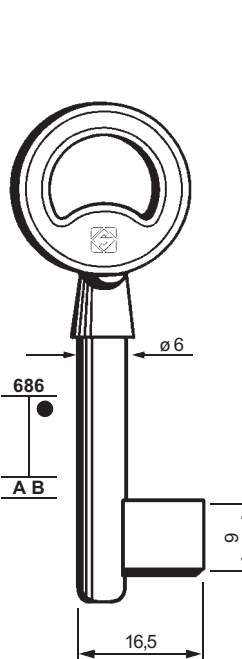

VAC301

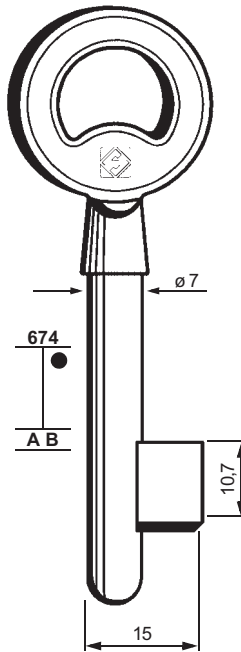

VAC302

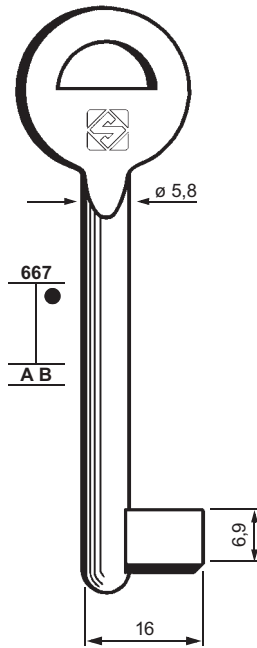

6VAC1



6VAC1-1



6VAC1-2



6VAC1-6

FOR:
PER:

VIGIE PICARD

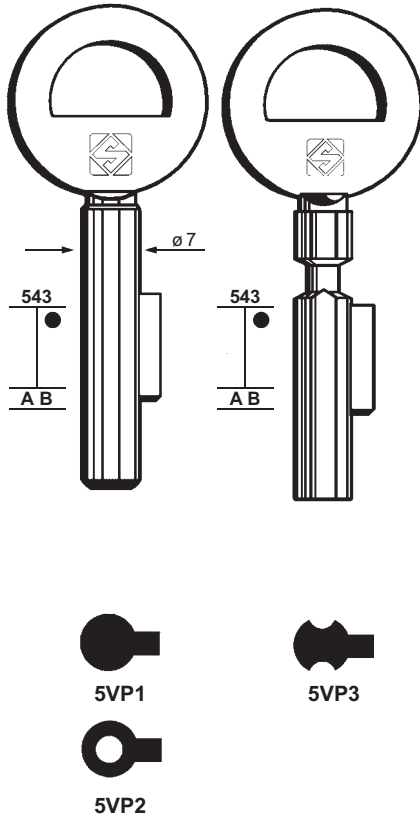

WG

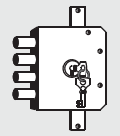
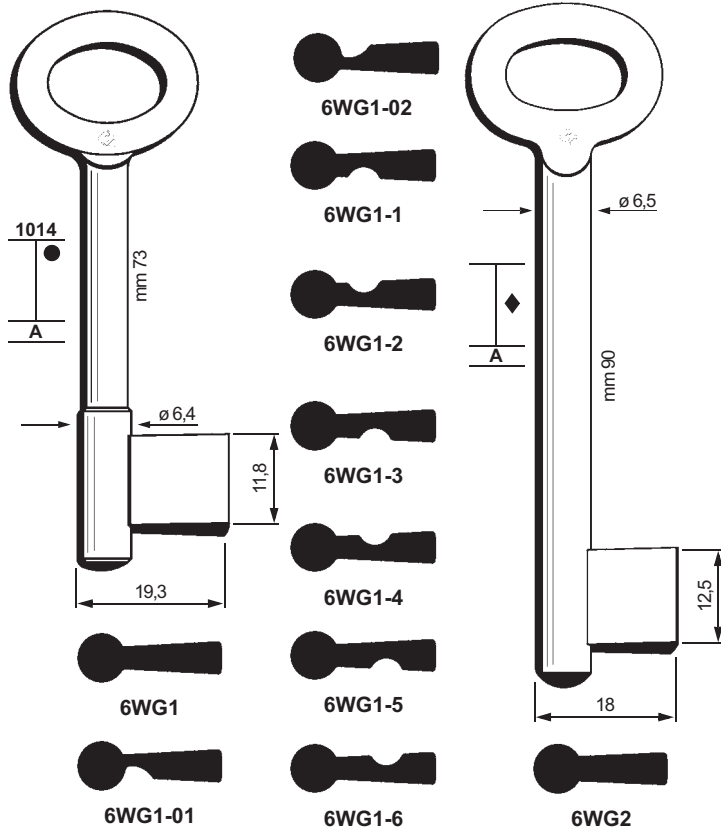

109

FOR/PER

VIGIE PICARD (F)

V.S.B. (NL)
NEMEF (100-100)

WG (A)

WITTKOPP (D)
BODE (87)

YALE (GB)

ZORATTO (I)

FOR:
PER:

YALE

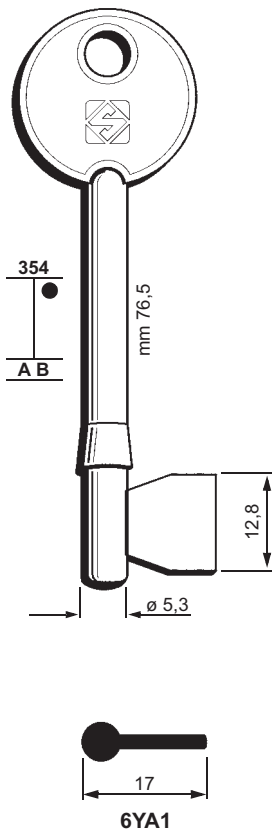

ZORATTO

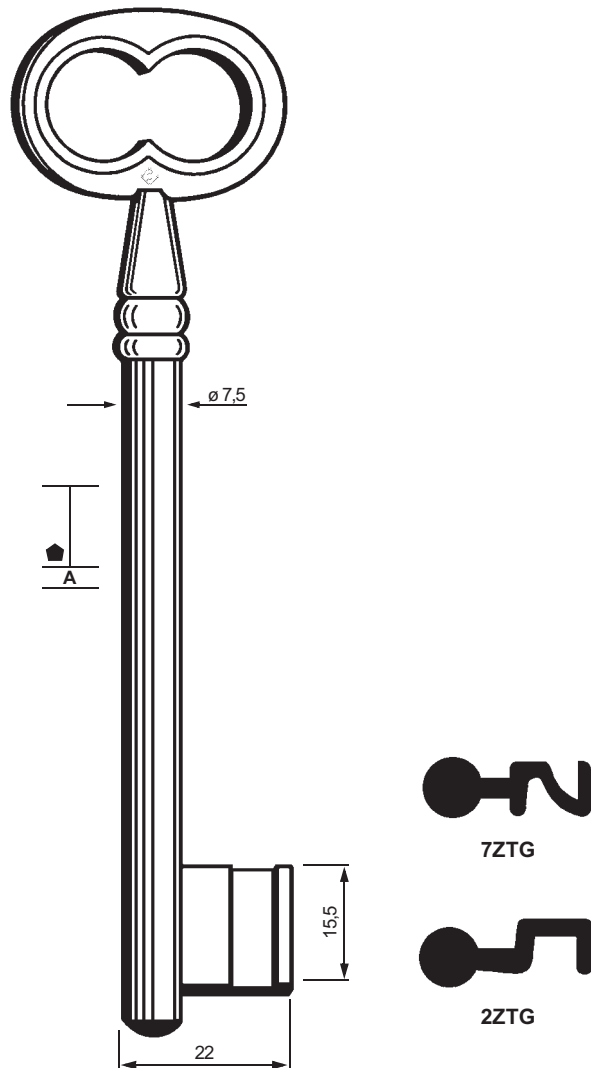

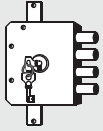

110

FOR/PER

CHIAVI ADATTABILI
MASCHI a GORGES

FOR:
PER:

CHIAVI ADATTABILI - MASCHI a GORGES

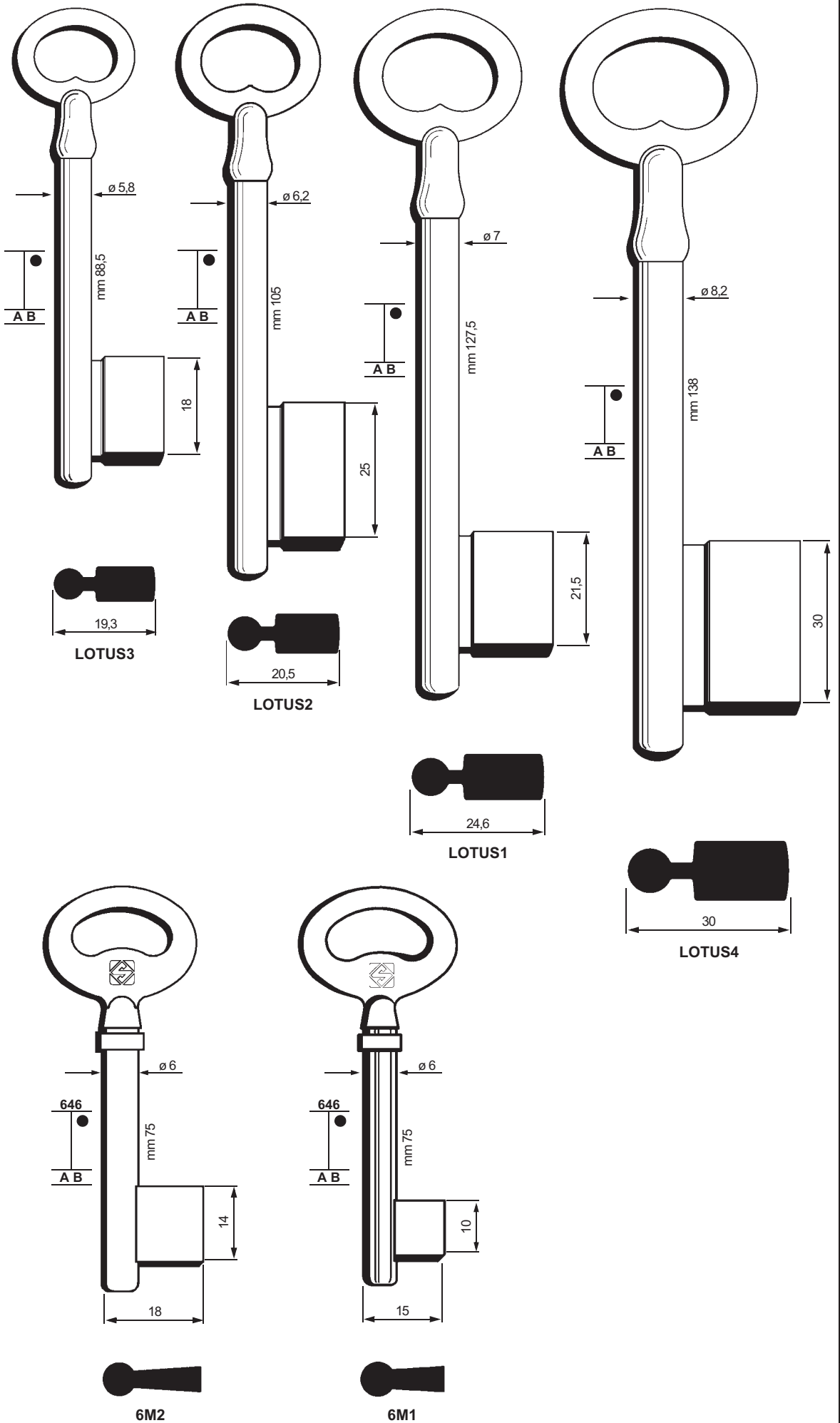

FOR:
PER:

CHIAVI ADATTABILI - FEMMINE a GORGES

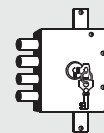

111

FOR/PER

CHIAVI ADATTABILI
FEMMINE a GORGES

FEMMINE a GORGES

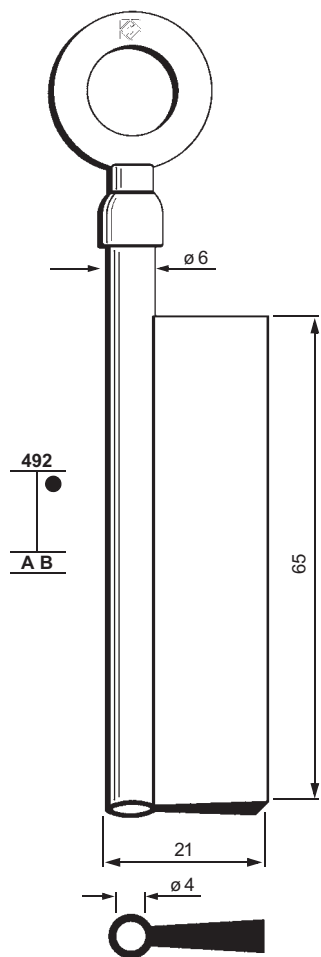

6F31

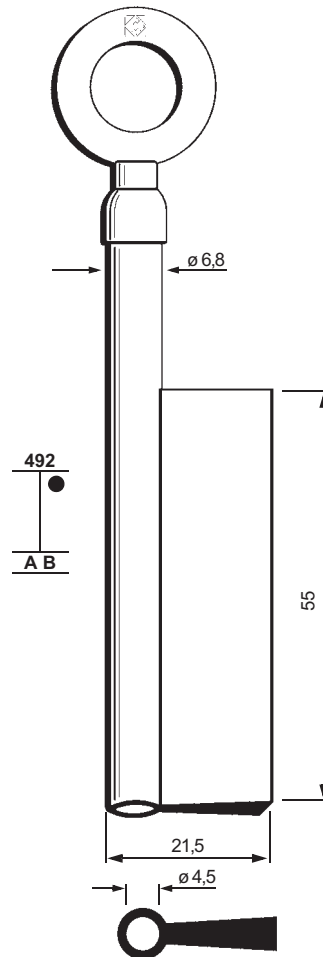

6F34

FOR:
PER:

FEMMINE a GORGES

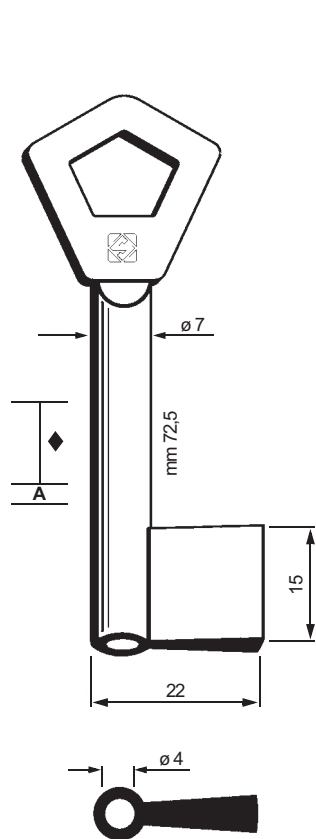

6922P4

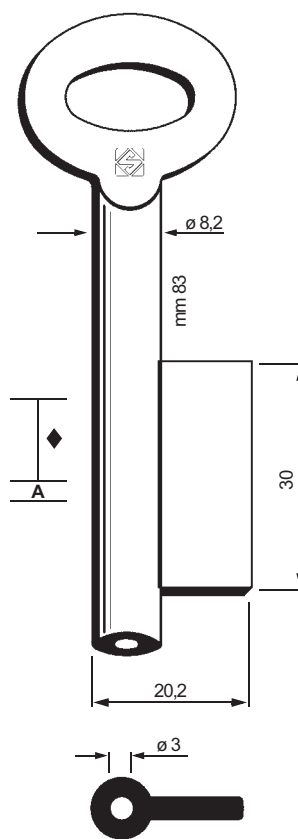

G707

GERMANY

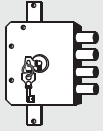

112

FOR/PER

CHIAVI ADATTABILI
MASCHI a GORGES

CHIAVI ADATTABILI
FEMMINE a GORGES

FOR:
PER:

CHIAVI ADATTABILI - MASCHI a GORGES

Art.	Ø	L
6M3	5,5	80
6M4	6	80
6M5	5	90
6M6	5,5	90
6M7	6	90
6M8	5	95
6M9	5,5	95
6M10	6	95
6M11	5	100
6M12	5,5	100
6M13	6	100
6M14	6,5	100

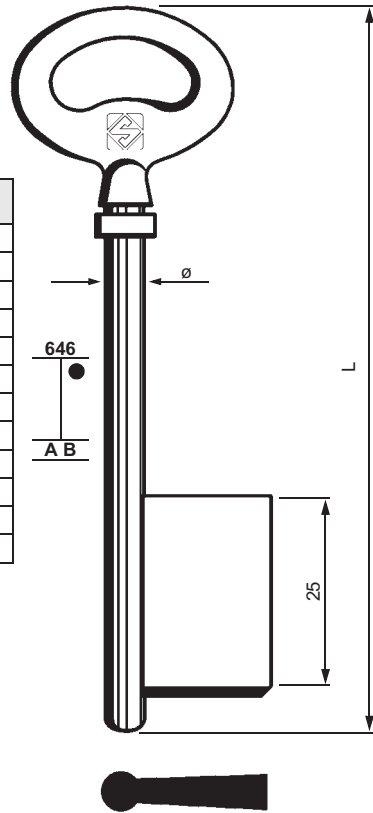

Art.	Ø	L
6M15	5	95
6M16	5,5	95
6M32	5,8	95
6M17	6	98
6M18	6,5	95
6M19	5	100
6M20	5,5	100
6M21	6	100
6M22	6,5	100
6M23	5	110
6M24	5,5	110
6M25	6	110
6M26	6,5	110
6M27	5	120
6M28	5,5	120
6M29	6	120
6M30	6,5	120
6M35	6	140

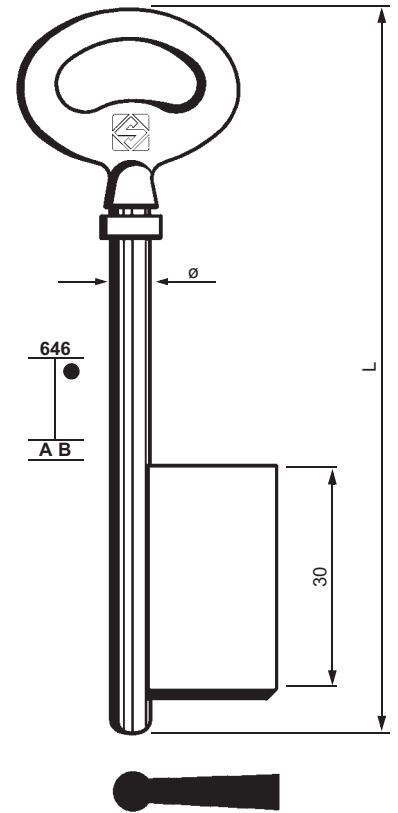

FOR:
PER:

CHIAVI ADATTABILI - FEMMINE a GORGES

Art.	Ø	L	Ø i
6F3	5,5	75	3,5
6F4	6	75	4
6F5	5	85	3
6F6	5,5	85	3,5
6F7	6	85	4
6F8	5	90	3
6F9	5,5	90	3,5
6F10	6	90	4
6F11	5	95	3
6F12	5,5	95	3,5
6F13	6	95	4
6F14	6,5	95	4

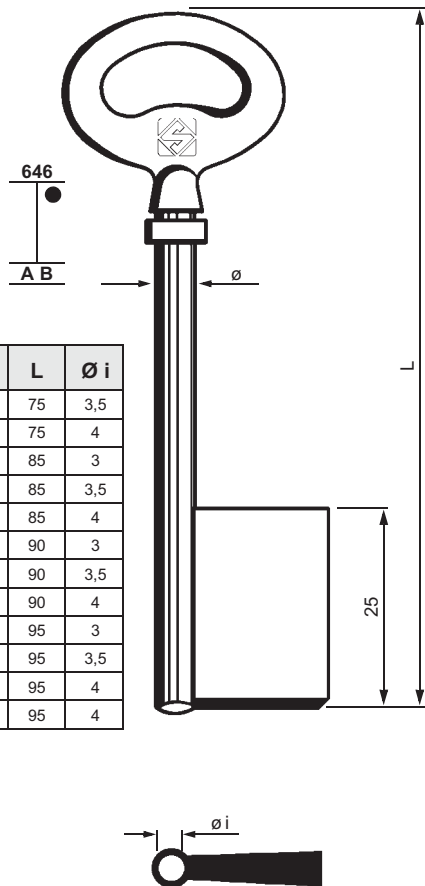

Art.	Ø	L	Ø i
6F15	5	90	3
6F16	5,5	90	3,5
6F17	6	93	4
6F18	6,5	90	4
6F19	5	95	3
6F20	5,5	95	3,5
6F21	6	95	4
6F22	6,5	95	4
6F23	5	105	3
6F24	5,5	105	3,5
6F25	6	105	4
6F26	6,5	105	4
6F27	5	115	3
6F28	5,5	115	3,5
6F29	6	115	4
6F30	6,5	115	4

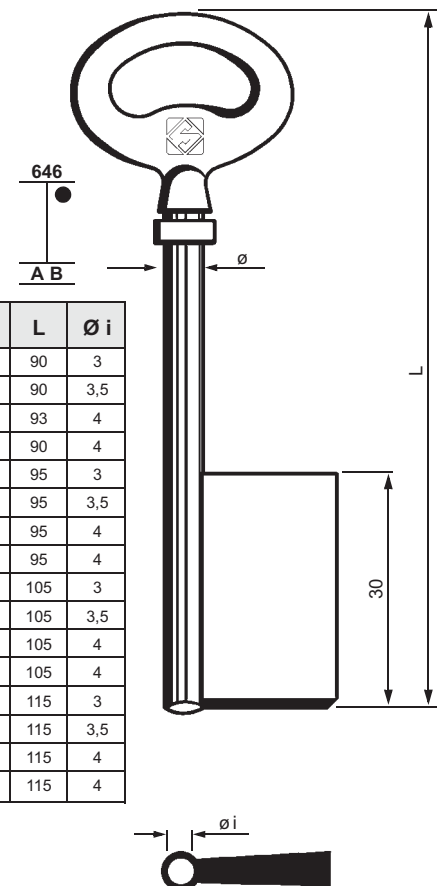

FOR:
PER:

MASCHI a GORGES

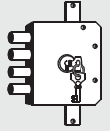

113

FOR/PER

MASCHI A GORGES

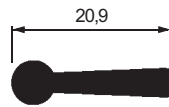
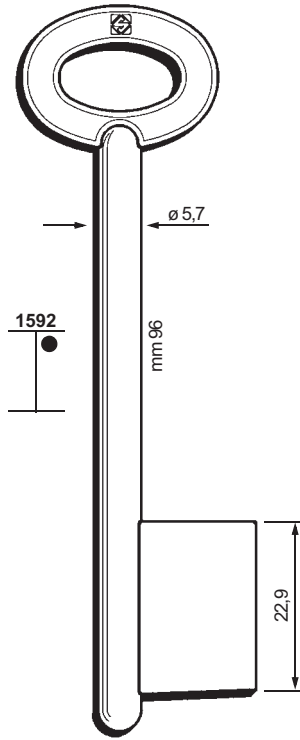

6M38

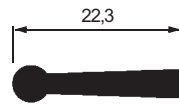
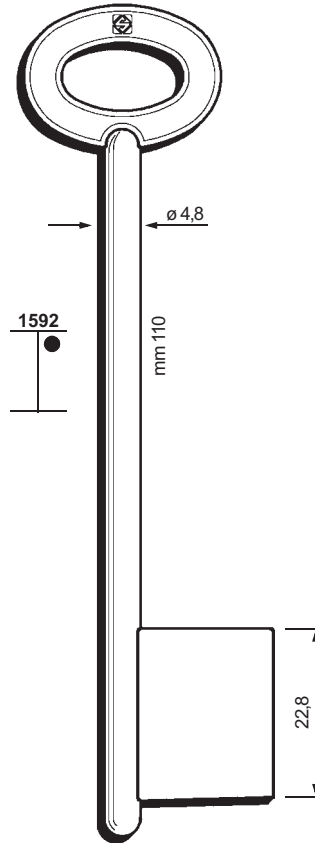

6M37

FOR:
PER:

MASCHI a GORGES

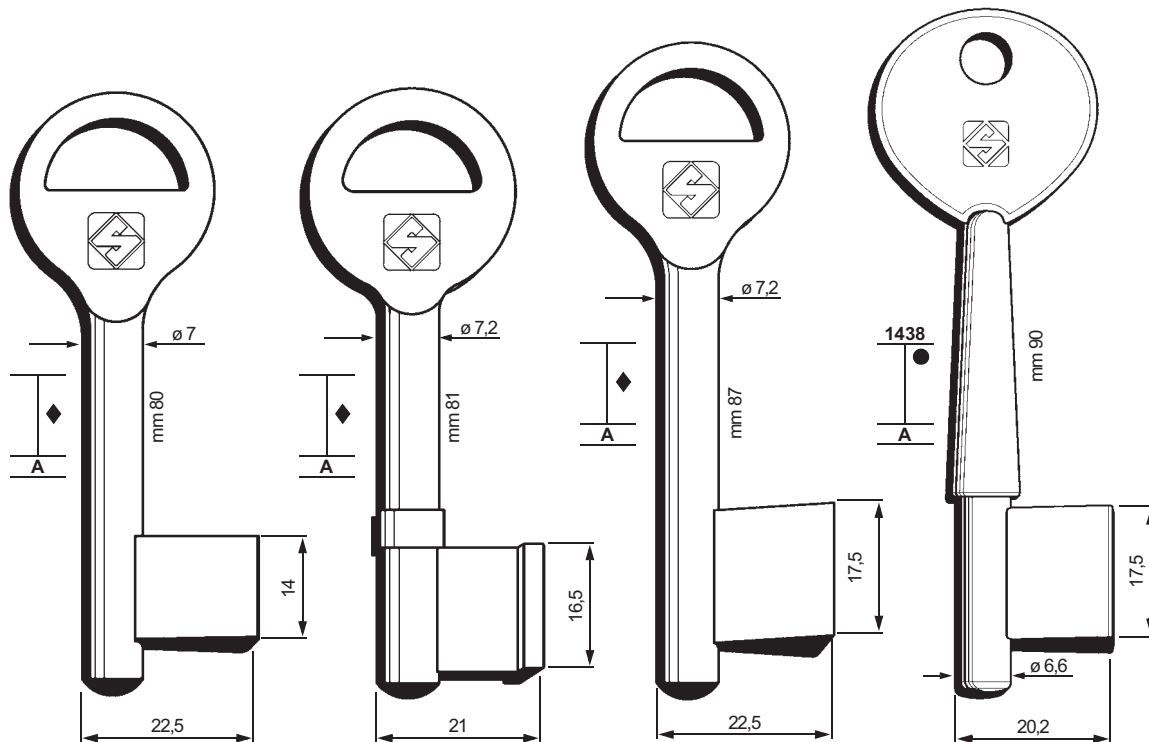

G685



G713



G662



6M36

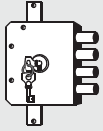

114

FOR:
PER:

MASCHI a GORGES

PER/FOR:
GLITTENBERG

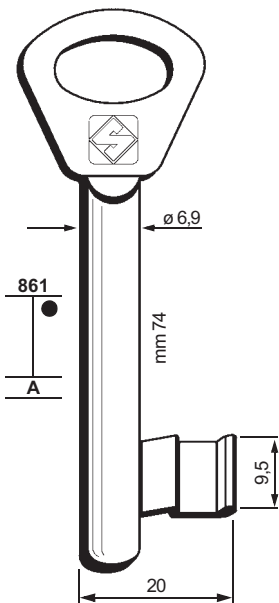

G6-1



G6-41



G6-109



G6-235



G6-2



G6-42



G6-110



G6-236



G6-9



G6-53



G6-121



G6-263



G6-10



G6-54



G6-122



G6-264



G6-13



G6-55



G6-145



G6-273



G6-14



G6-56



G6-146



G6-274



G6-15



G6-57



G6-161



G6-285



G6-16



G6-58



G6-162



G6-286



G6-21



G6-69



G6-173



G6-287



G6-22



G6-70



G6-174



G6-288



G6-31



G6-81



G6-183



G6-32



G6-82



G6-184



G6-37



G6-99



G6-217



G6-38



G6-100



G6-218

FOR:
PER:

MASCHI e FEMMINE a GORGES

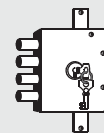

115

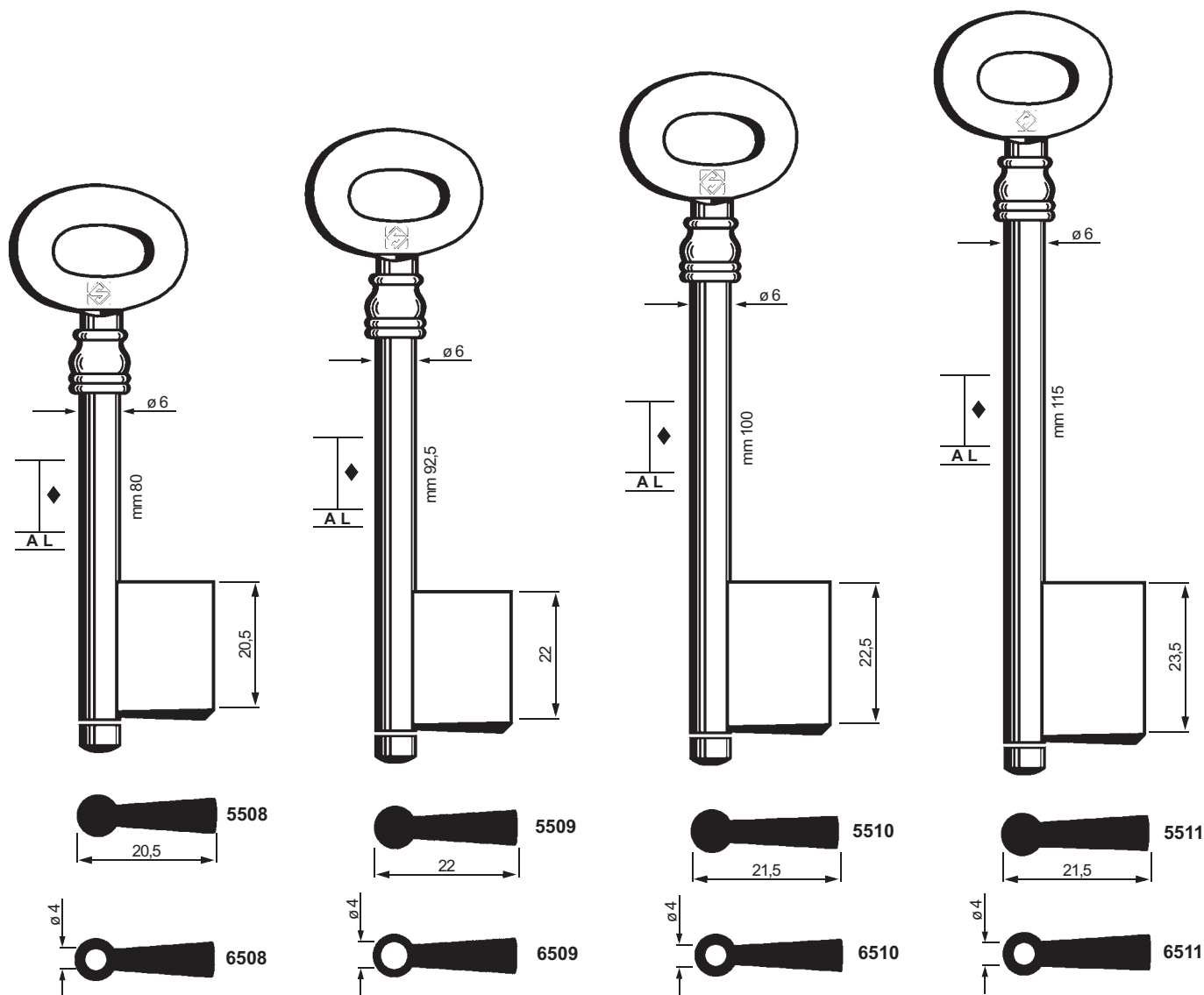



FOR:
PER:

MASCHI e FEMMINE a GORGES

116

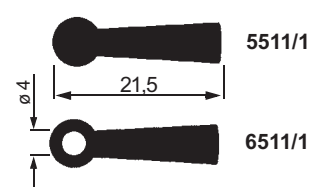
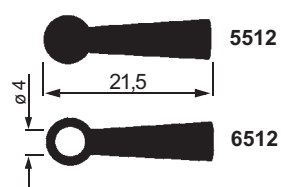
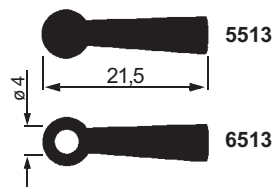
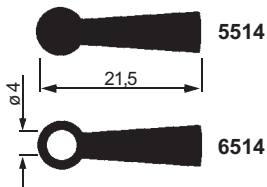
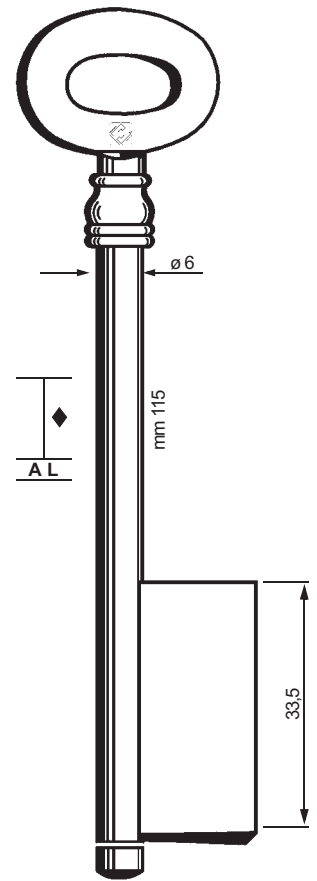
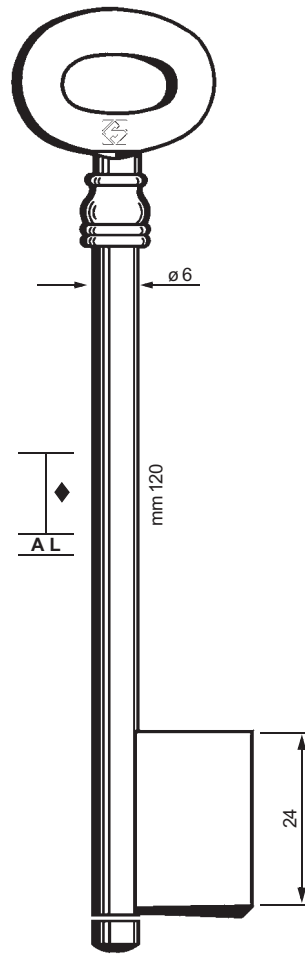
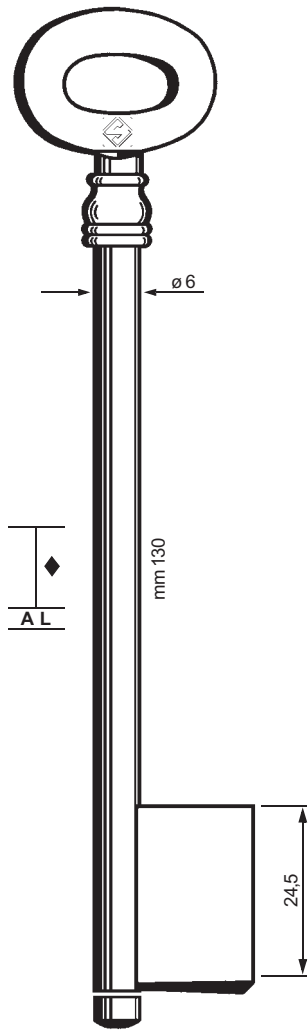
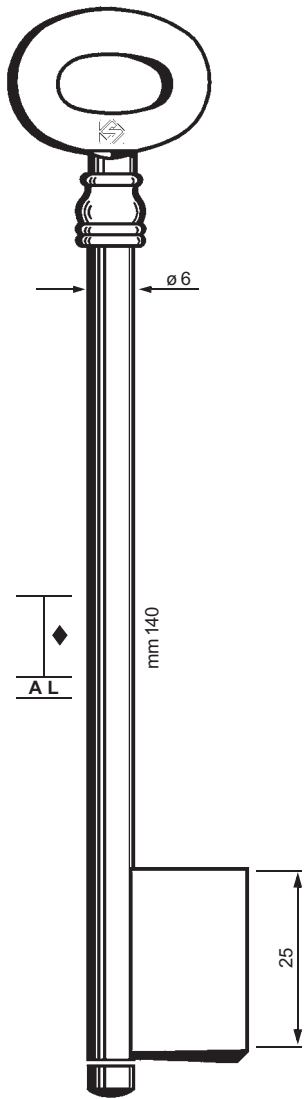

FOR:
PER:

MASCHI e FEMMINE con MAZZETTA

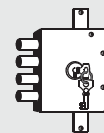

117

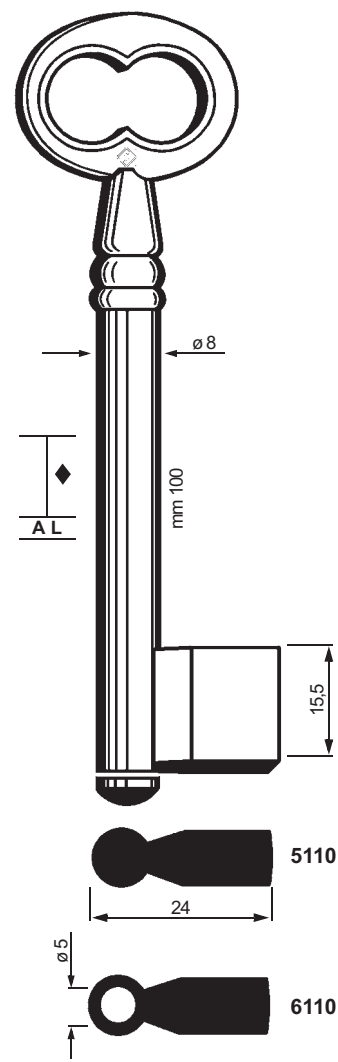
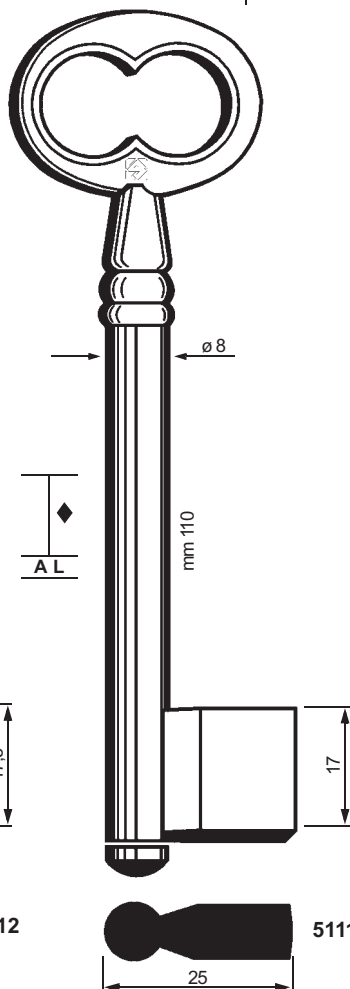
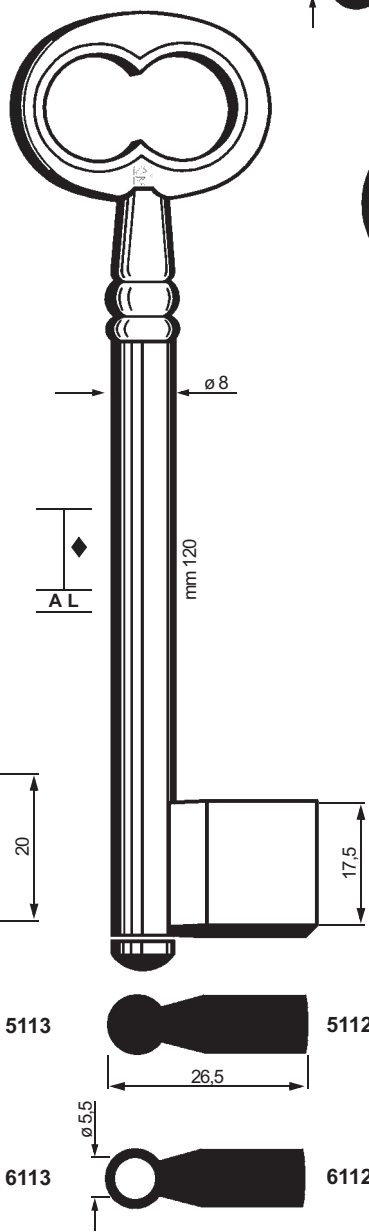
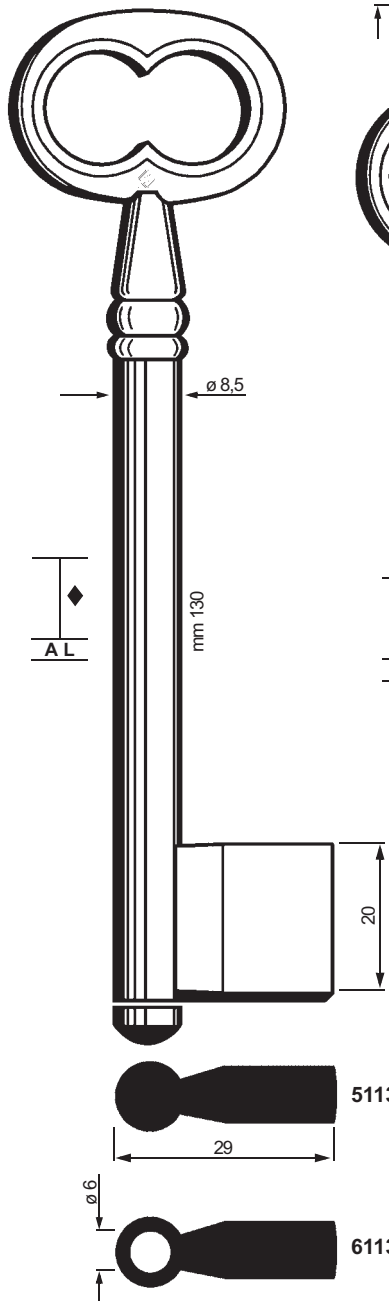
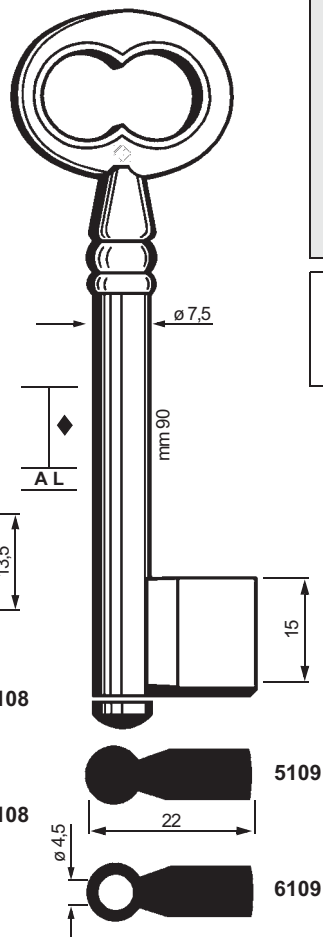
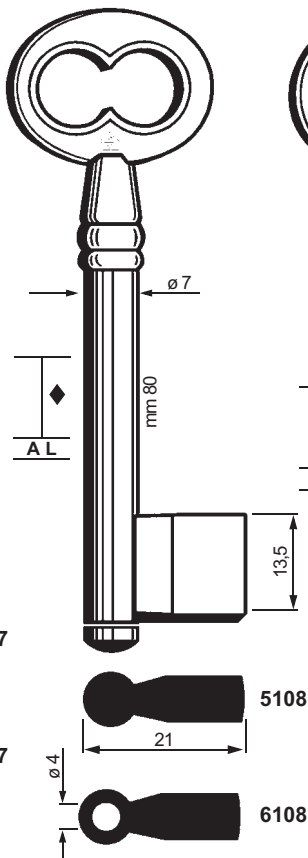
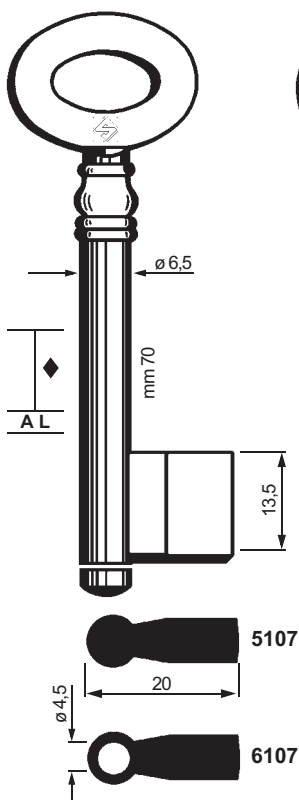
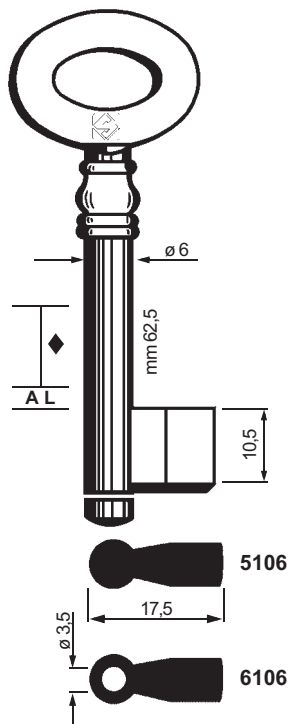

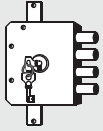

118

FOR:

PER:

MASCHI e FEMMINE con MAZZETTA

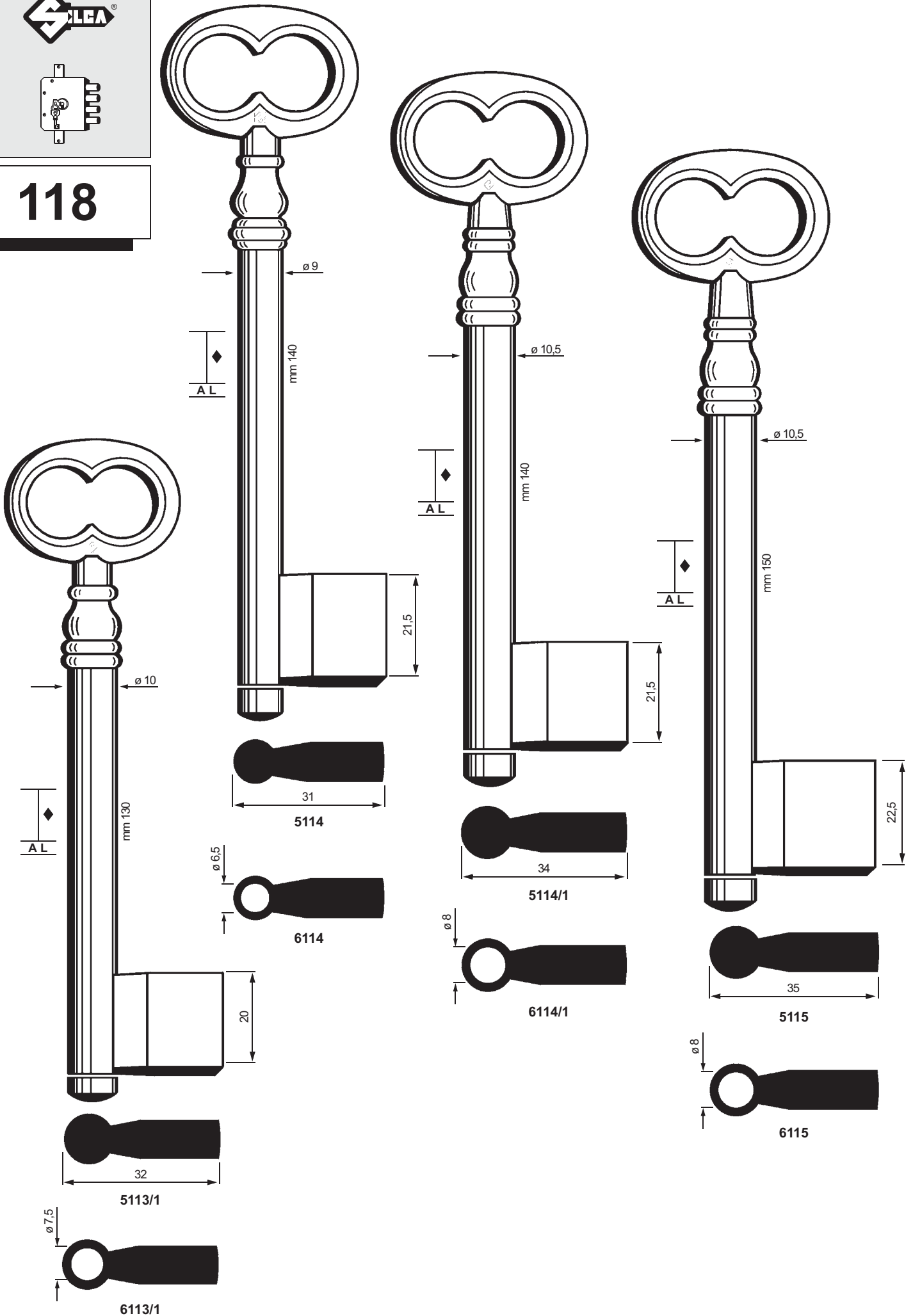

FOR:
PER:

FEMMINE FIRENZE

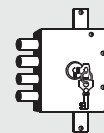

119

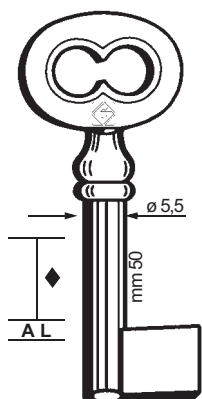

6605

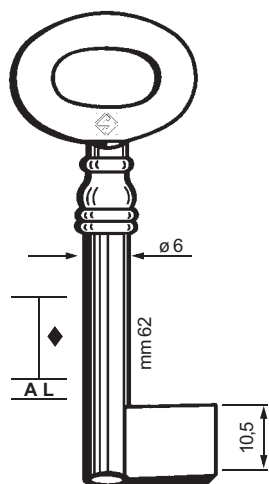

6606

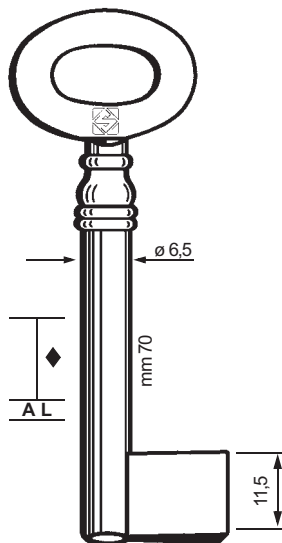

6607

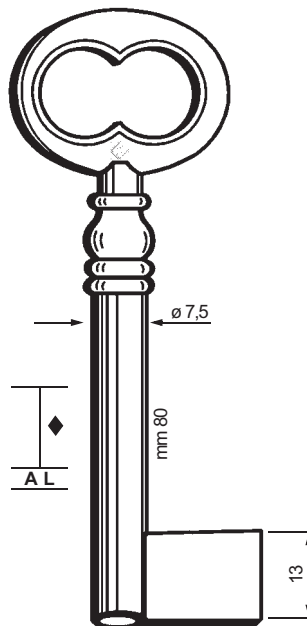

6608

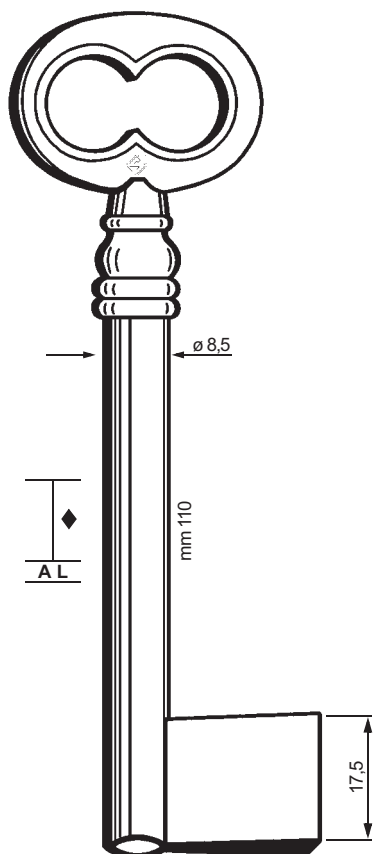

6611

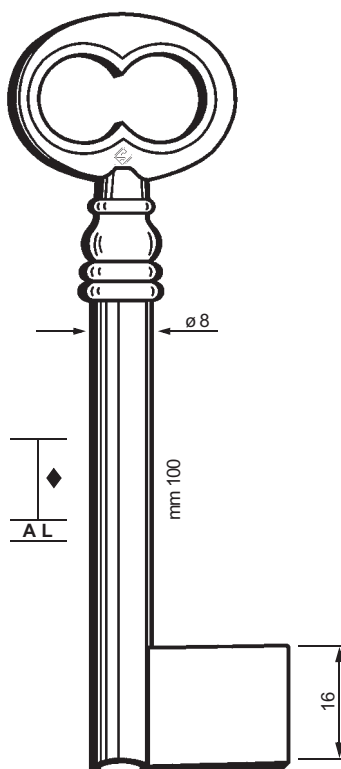

6610

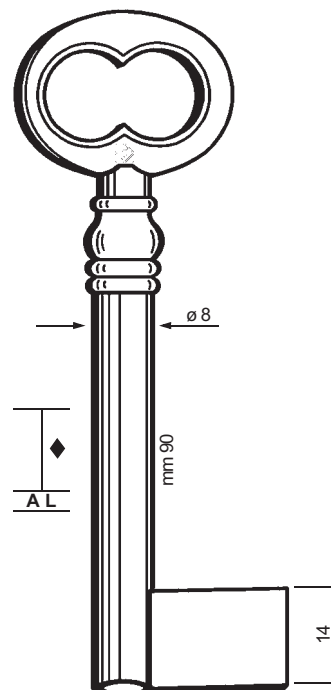

6609

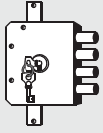

120

FOR:
PER:

FEMMINE FIRENZE

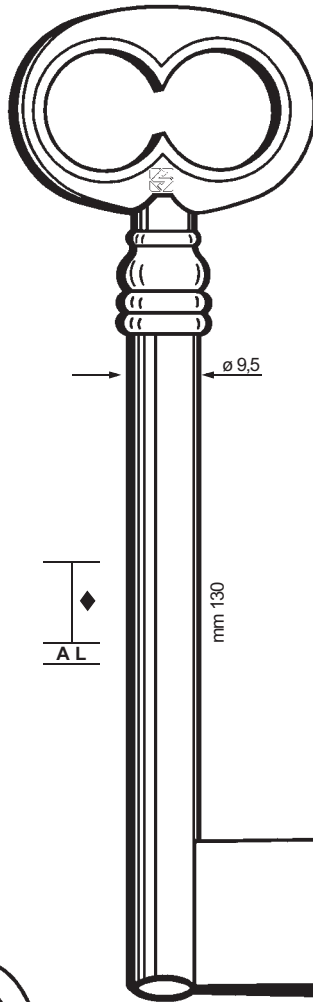

AL

mm 130

AL

mm 140

20.5

$\varnothing 7$

32

6613

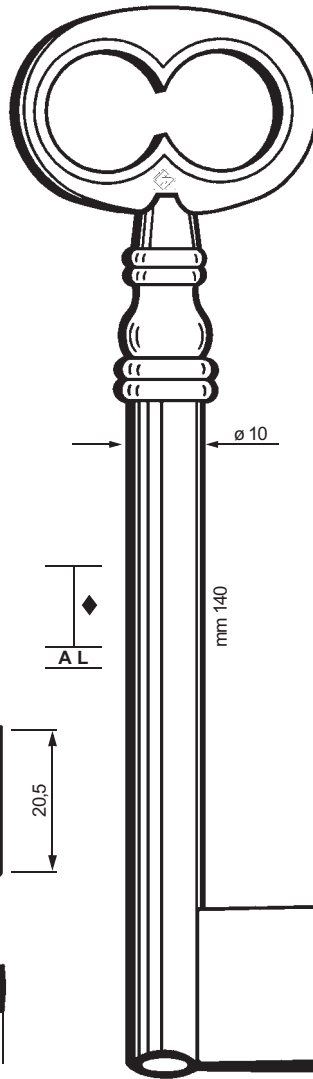

$\varnothing 10$

AL

$\varnothing 8$

34.5

6614

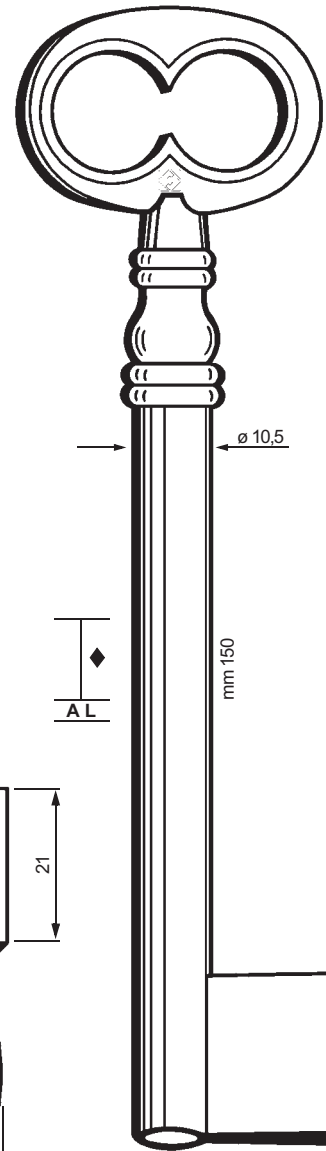

AL

mm 150

22.5

$\varnothing 9$

35

6615

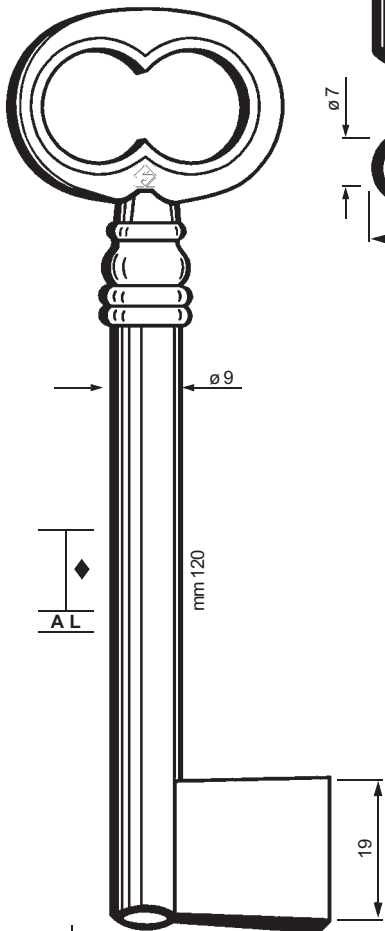

AL

mm 120

19

$\varnothing 6$

29

6612

FOR:
PER:

MASCHI e FEMMINE

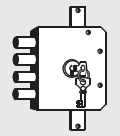

121

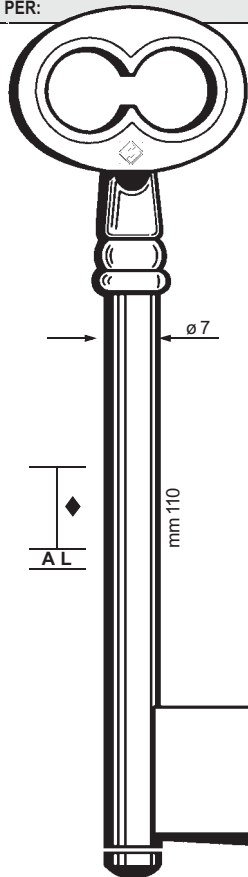

5411

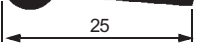

6411

alla LOMBARDA

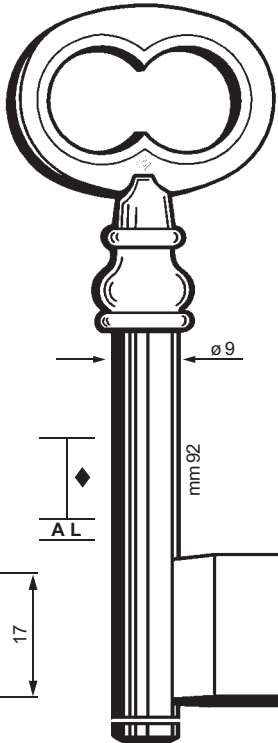

5309



6309

per CANCELLO

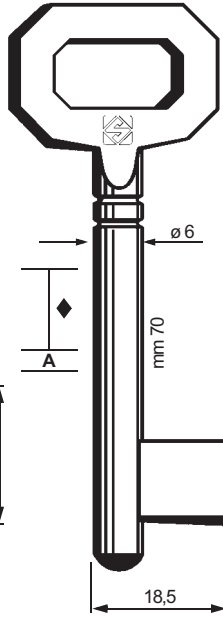

5602

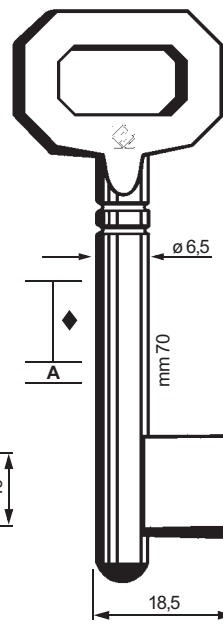

5601



tipo PATENT

tipo PATENT

FOR:
PER:

MASCHI e FEMMINE per MOBILI

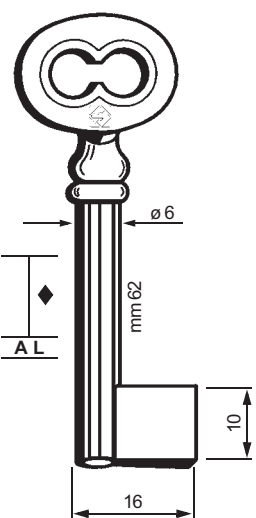

6506

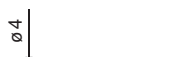

ITALY

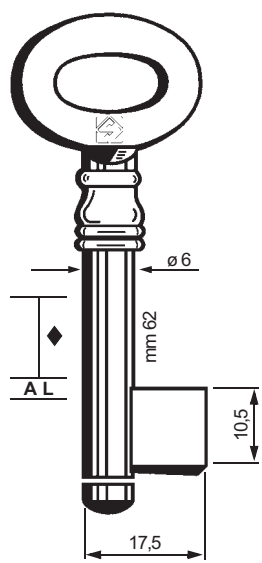

5206



ITALY

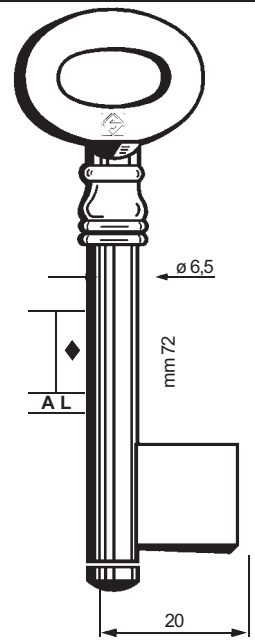

5207



ITALY

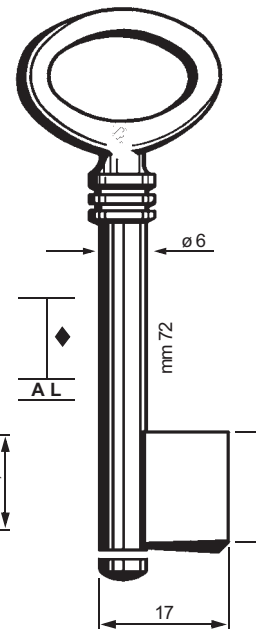

5507



FRANCE

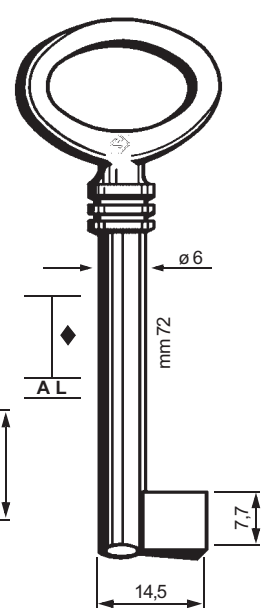

6507/1



FRANCE

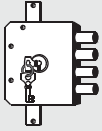

122

FOR:

PER:

MASCHI con CORONA

Art.	Ø
5818	4
5828	4,5
5838	5
5848	5,5

Art.	Ø
5817	4
5827	4,5
5837	5
5847	5,5

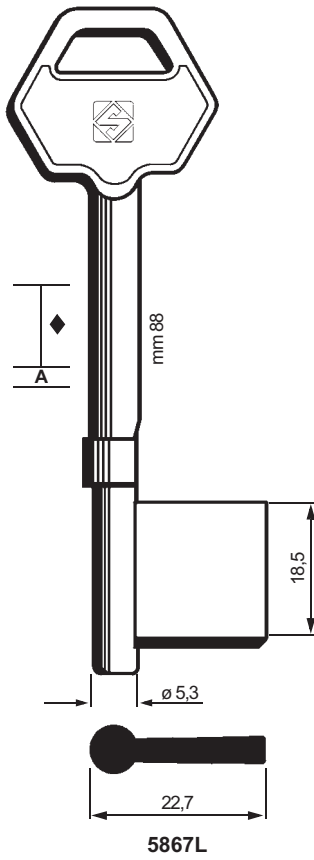

per LIPS

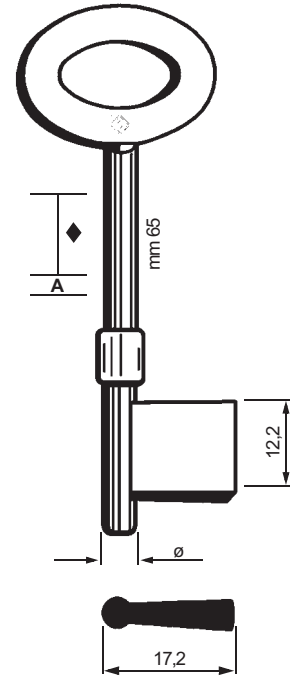
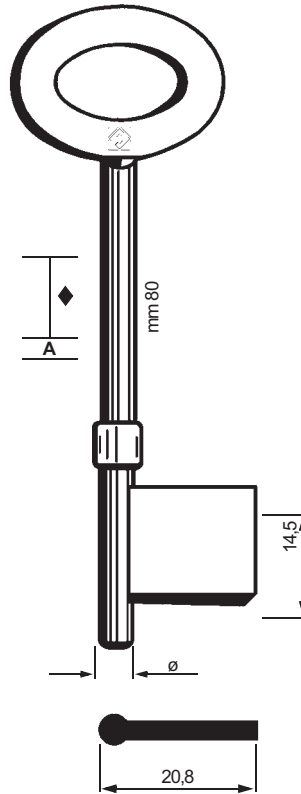

per LITTO

FOR:

PER:

MASCHI per CANCELLETTO

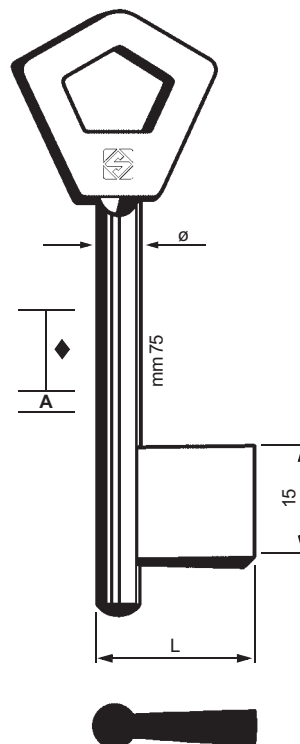
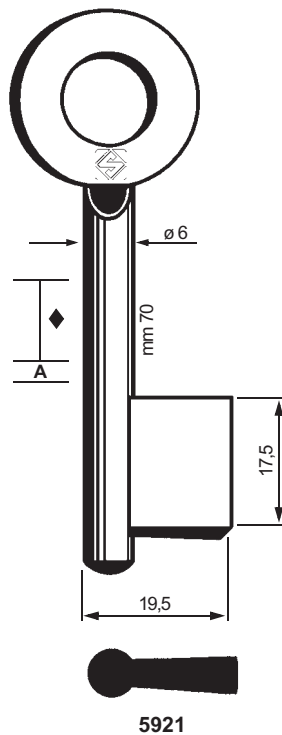
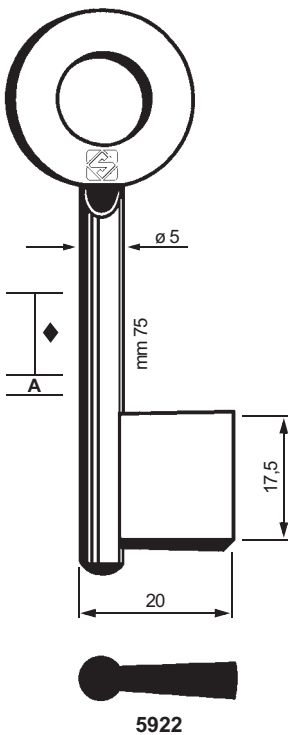

Art.	Ø	L
5922 P5	4	20,5
5922 P6	4,5	20,75
5922 P	5	21
5922 P1	5,5	21,25
5922 P2	6	21,5
5922 P3	6,5	21,75
5922 P4	7	22
5922 P7	7,5	22,25
5922 P8	8	22,5

FOR:
PER:

MASCHI tipo PIEMONTE

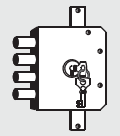

123

Art.	Ø
5908	3,5
5910	4,5

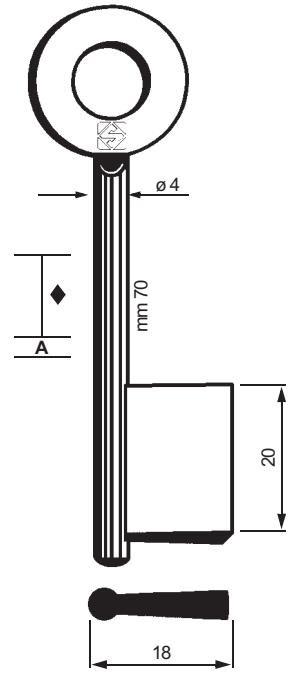
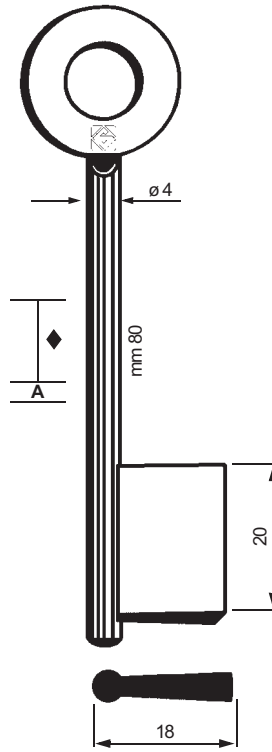
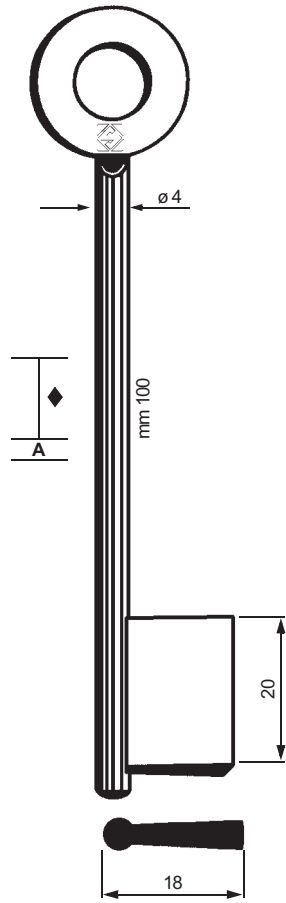
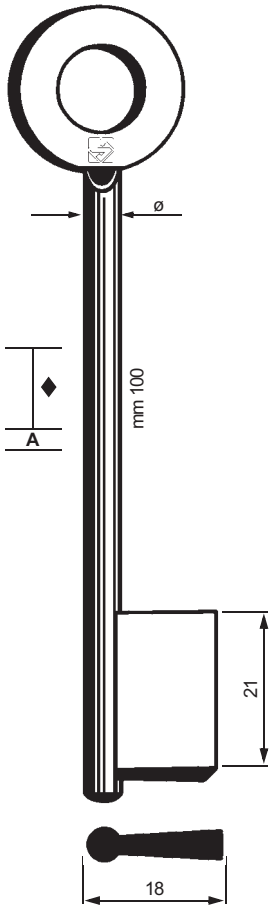

5909

5903

5901

BEC DE CAN

FOR:
PER:

MASCHI e FEMMINE da CASSETTO

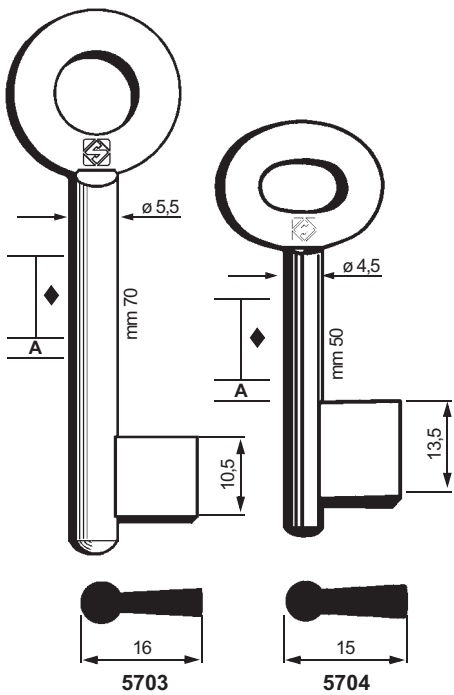

MASCHI

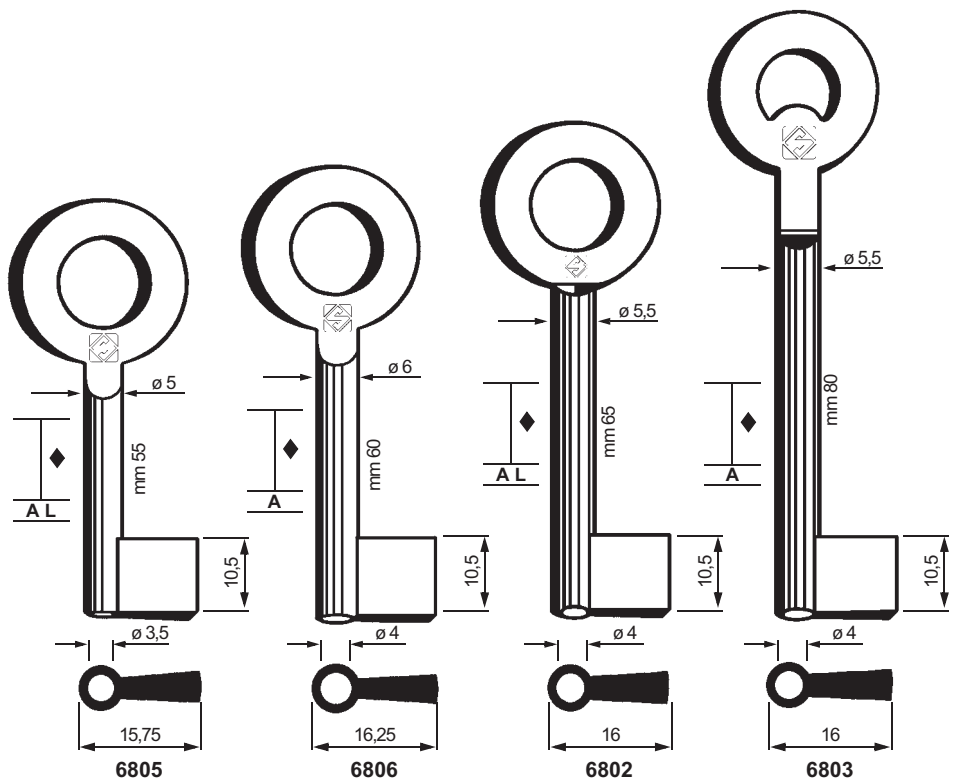

FEMMINE

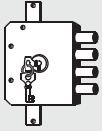

FOR:
PER:

MASCHI serie SPECIALE

124

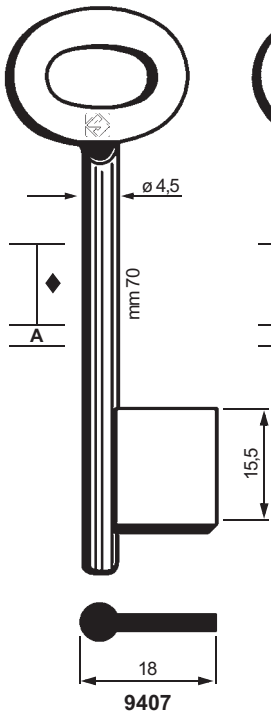

Mod. SAUDI

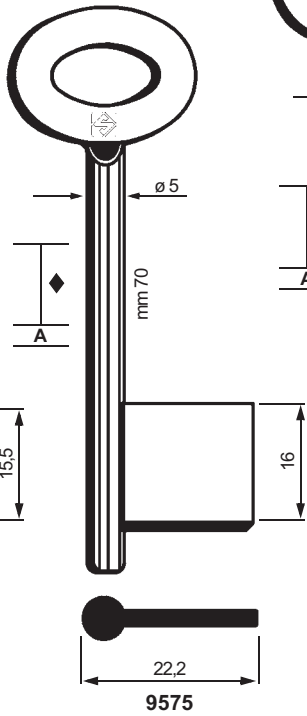

Mod. U.K.

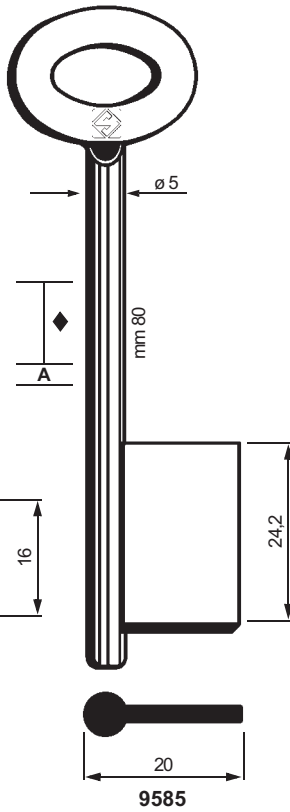

Mod. U.K.

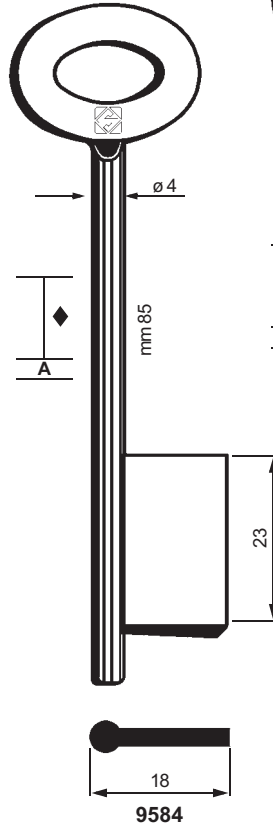

Mod. U.K.

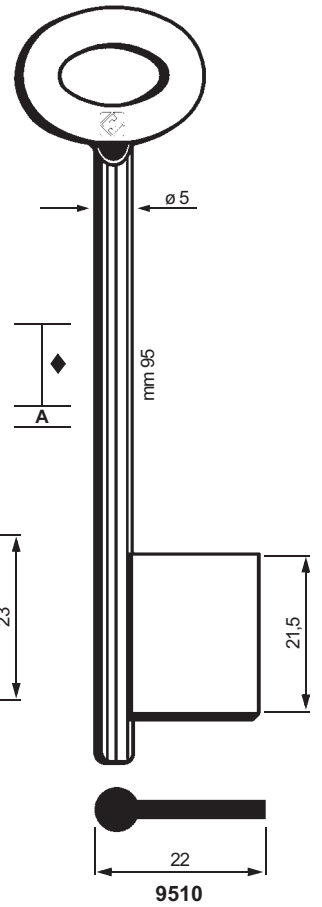

Mod. U.K.

FOR:
PER:

MASCHI e FEMMINE

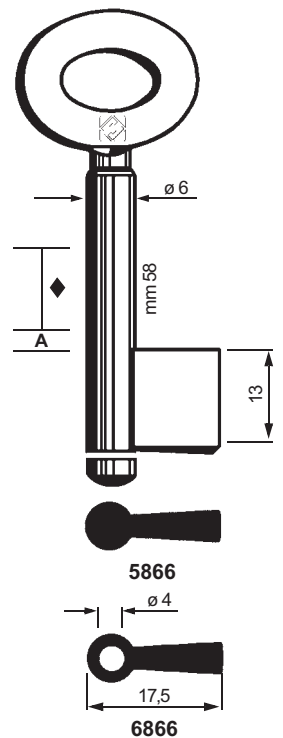
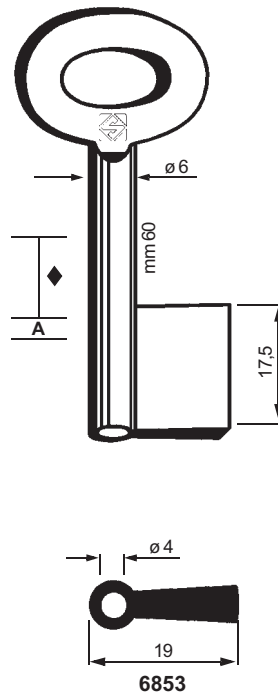
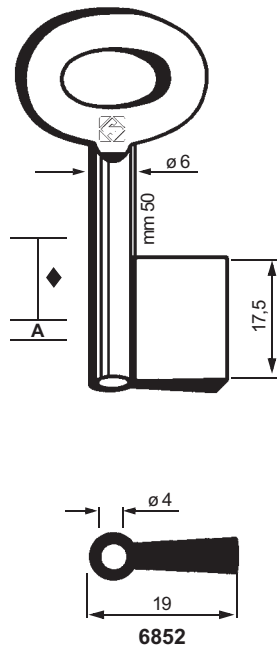
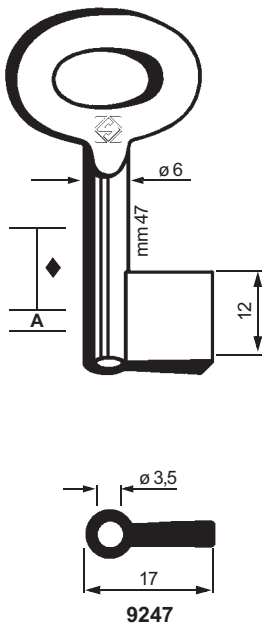

per CASSETTE PORTAVALORI

FOR:
PER:

FEMMINE

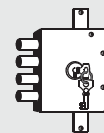

125

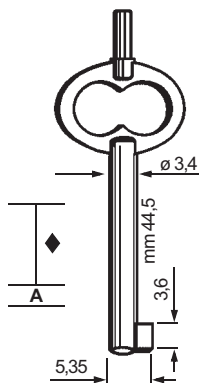

6750

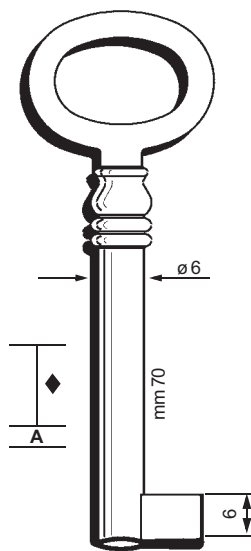

6507/4

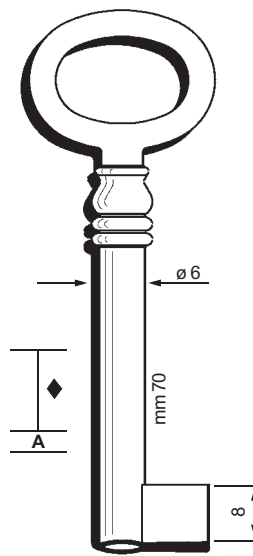

6507/2

per MANETTE
chiavi "POLICE"

GERMANY

FOR: **MASCHI e FEMMINE per SERRANDA**

MASCHI tipo TRIESTE

Art.	Tipo	\varnothing	$\varnothing i$
9107	M	7	
9207	F	7	4,5
9102	M	8	
9202	F	8	4,5

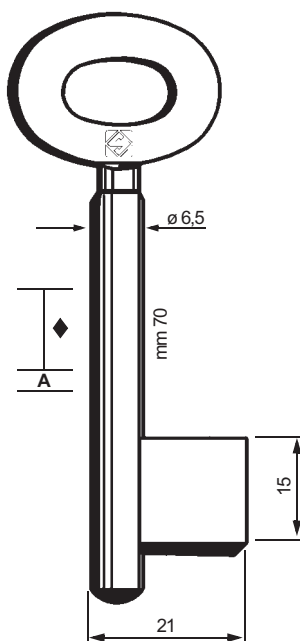
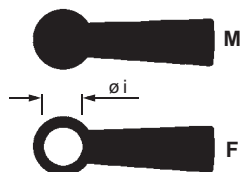
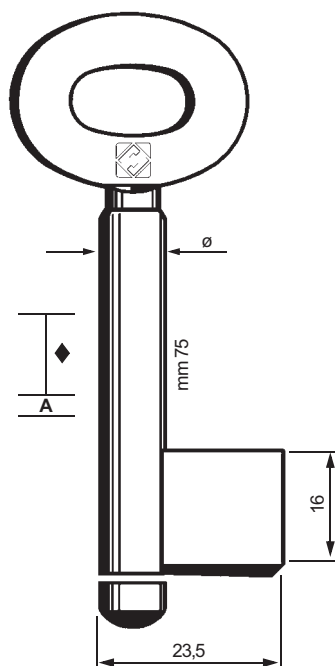

9404

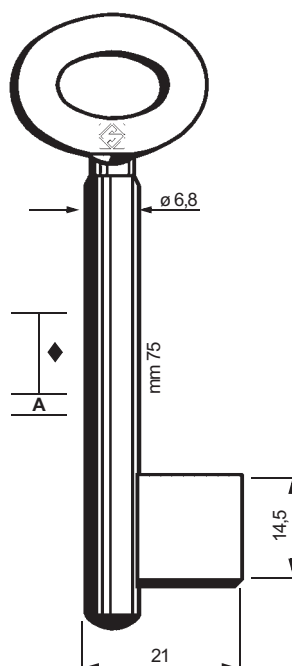

9601

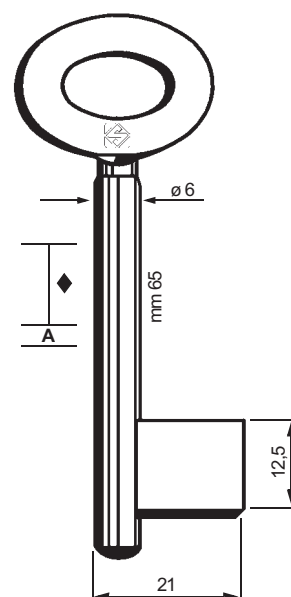

9600

per serrature Mod. WERTHEIM

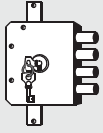

126

FOR:
PER:

MASCHI

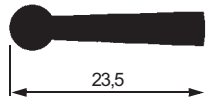
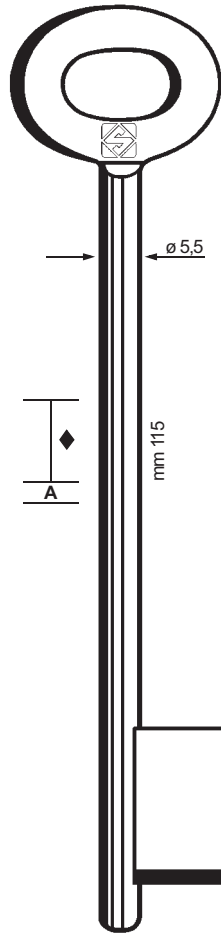

9755

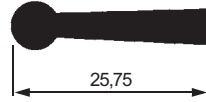
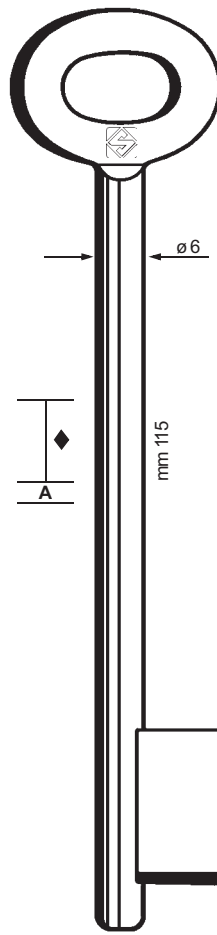

9706

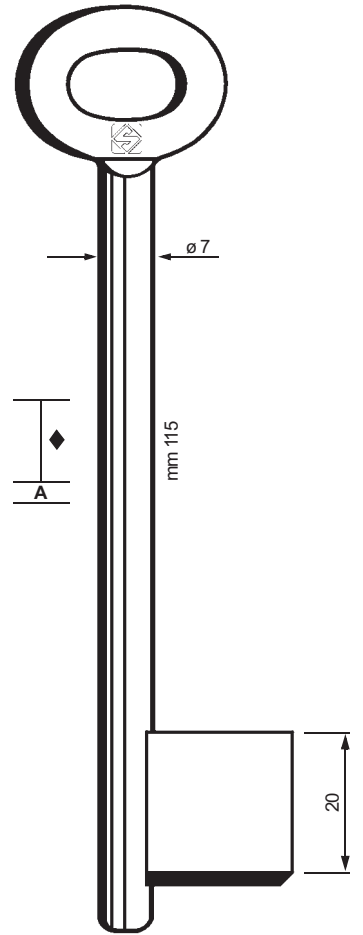

9707

Mod. BENELUX

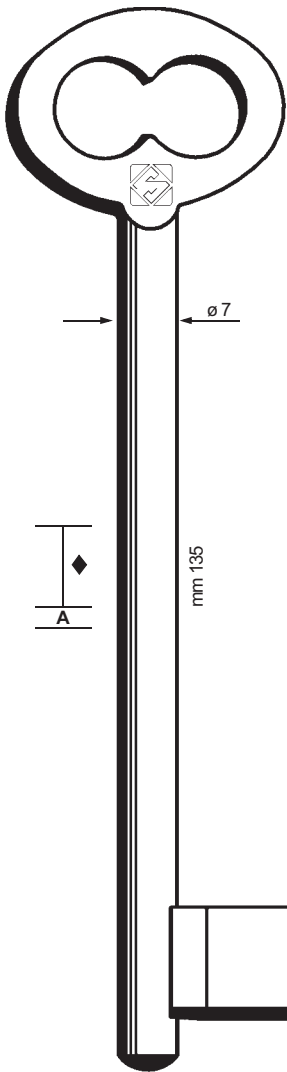

5114/2

ITALY



Patent keys
Chiavi patent
Patentschlüssel
Clés patent
Llaves patent
Chaves Patent



IMPORTANT - IMPORTANTE - WICHTIG - IMPORTANT - IMPORTANTE - IMPORTANTE

GB

IMPORTANT - In order to improve service we have updated the information about patent keys in the catalogue.

Where applicable, you will find key references for replacement blanks or for key blanks that can be used in the place of the original one.

CATALOGUE INDICATIONS:

	Obsolete keys not available from stock.
"REPLACED BY"	Obsolete references with the symbol are replaced by the key references indicated.
"OBTAINABLE FROM"	Obsolete references with the symbol can be obtained by machining the key reference indicated.

I

IMPORTANTE - Al fine di migliorare il servizio abbiamo aggiornato le informazioni a catalogo relative alle chiavi patent.

Troverete indicate, in corrispondenza degli articoli che le prevedono, le referenze chiavi degli articoli sostitutivi o quelle degli articoli che possono essere utilizzati in alternativa all'articolo originario.

INDICAZIONI A CATALOGO:

	Chiavi obsolete non disponibili a stock.
"SOSTITUITE DA"	Le referenze obsolete contraddistinte dal simbolo sono sostituite dalle referenze chiave indicate.
"OTTENIBILI CON"	Le referenze obsolete contraddistinte dal simbolo sono ottenibili, tramite opportune lavorazioni, con la referenza chiave indicata.

D

WICHTIG - Zur Verbesserung des Service wurden die Informationen im Katalog bezüglich Patentschlüssel aktualisiert.

Sie finden zu den entsprechenden Artikeln Angaben bezüglich Referenzschlüssel für Ersatzartikel oder Artikel, die als Alternative zum Originalartikel verwendet werden können.

ANGABEN IM KATALOG:

	Überholte Schlüssel, die nicht mehr auf Lager sind.
"ERSETZT DURCH"	Die durch das Symbol gekennzeichneten überholten Referenzartikel wurden durch die angegebenen Referenzschlüssel ersetzt.
"ERHÄLTICH MIT"	Die durch das Symbol gekennzeichneten Referenzartikel sind durch Bearbeitungen der angegebenen Referenzschlüssel erhältlich.

F

IMPORTANT - Dans le but d'améliorer notre service, nous avons mis à jour les informations concernant les clés Patent dans notre catalogue.

Vous trouverez, pour les articles où la chose est prévue, les références clés des articles de remplacement ou celles des articles pouvant être utilisés en alternative à l'article original.

LÉGENDES DU CATALOGUE:

	Clés obsolètes non disponibles de stock.
"REPLACÉES PAR"	Les références obsolètes marquées du symbole sont remplacées par les références clés indiquées.
"RÉALISABLES PAR"	Les références obsolètes marquées du symbole sont réalisables, moyennant des usinages particuliers, avec la référence clé indiquée.

E

IMPORTANTE - Con el fin de mejorar el servicio, hemos puesto al día las informaciones en el catálogo correspondientes a las llaves patent.

Ud. podrá encontrar, en correspondencia con los artículos que las prevén, las referencias llaves de los artículos sustitutivos o las de los artículos que pueden utilizarse como alternativa al artículo originario.

INDICACIONES EN CATÁLOGO:

	Llaves obsoletas no disponibles en stock.
"SUSTITUIDAS POR"	Las referencias obsoletas marcadas por el símbolo están sustituidas por las referencias llave indicadas.
"OBTENIBLE CON"	Las referencias obsoletas marcadas por el símbolo pueden obtenerse, gracias a trabajos específicos, con la referencia llave indicada.

P

IMPORTANTE - A fim de melhorar o serviço, no catálogo foram atualizadas as informações relativas às chaves patent.

Estão indicadas, em correspondência dos artigos que as prevêm, as referências chaves dos artigos substitutivos ou as dos artigos que podem ser utilizados em alternativa ao artigo original.

INDICAÇÕES NO CATÁLOGO:

	Chaves antigas não disponíveis no estoque.
"SUBSTITUIDAS POR"	As referências antigas marcadas com o símbolo foram substituídas pelas referências chaves indicadas.
"PODEM SER OBTIDAS COM"	as referências antigas marcadas com o símbolo podem ser obtidas, por meio de trabalhos adequados, com a referência chave indicada.

FOR:
PER:

AGB  8

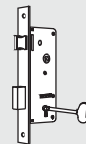

129

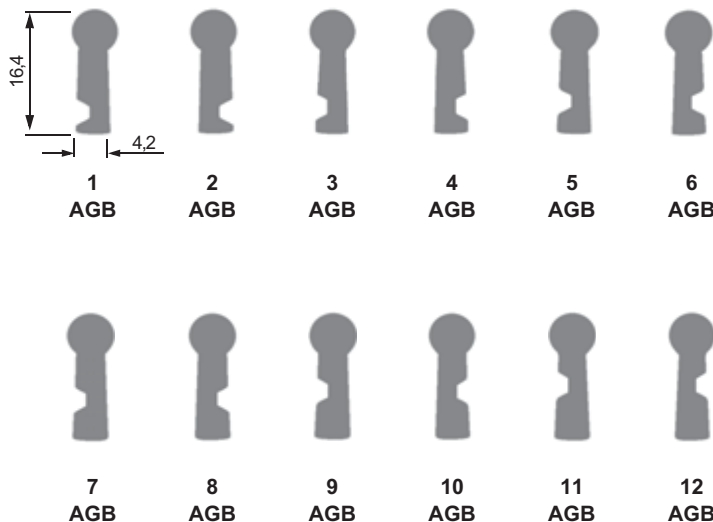
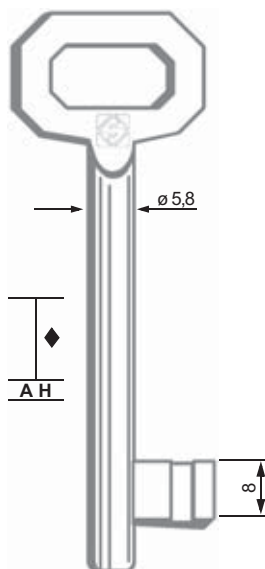

Chiavi obsolete non disponibili a stock - Obsolete keys not available from stock - Überholte Schlüssel, die nicht mehr auf Lager sind - Clés obsolètes non disponibles de stock - Llaves obsoletas no disponibles en stock - Chaves antigas não disponíveis no estoque



Replaced by: / Sostituite da:
Ersetzt durch: / Remplacées par:
Substituidas por: / Substituído por:



Obtainable with: / Ottenibili con:
Realisierbar mit: / Réalisables avec:
Obtenibles con: / Conseguível com:

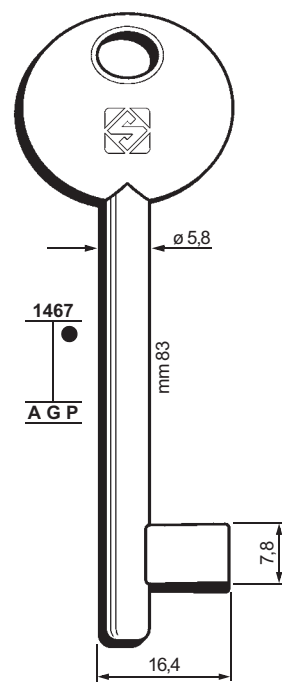
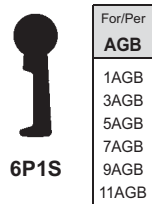
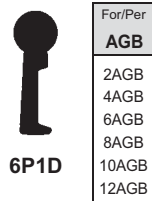
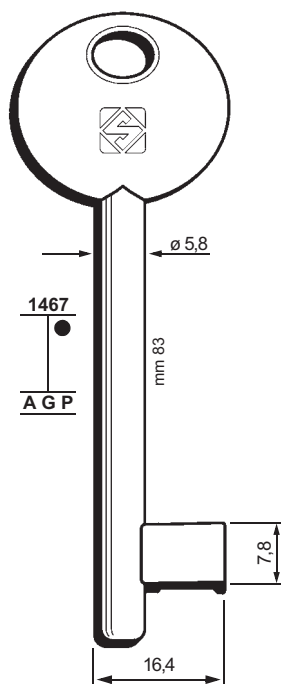

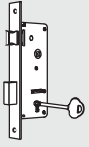

130

FOR:
PER:

BKS

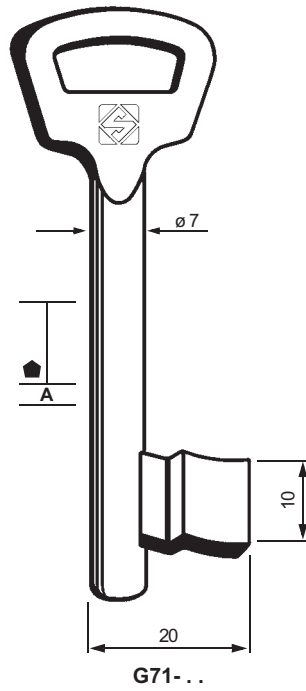

13 1/2



15 1/2



17 1/2



19 1/2



21 1/2



23 1/2



27 1/2



31 1/2

PER:
FOR:

BKS

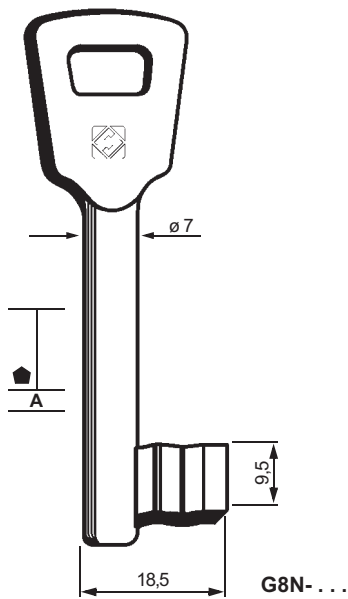

0



1



2



3



4



5



6



7



8



9

FOR:
PER:

BONAITI - "GB" ▣ 6

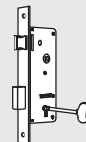

131

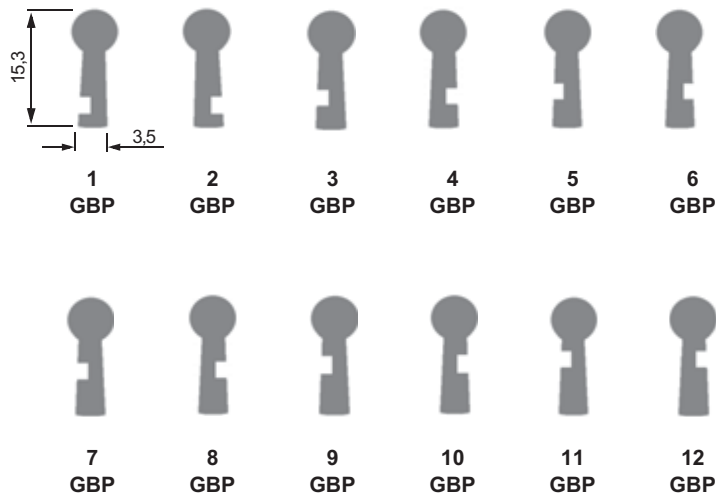
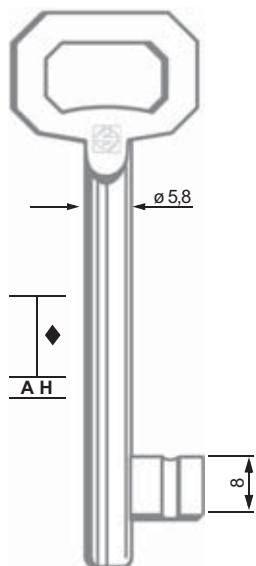

Chiavi obsolete non disponibili a stock - Obsolete keys not available from stock - Überholte Schlüssel, die nicht mehr auf Lager sind - Clés obsolètes non disponibles de stock - Llaves obsoletas no disponibles en stock - Chaves antigas não disponíveis no estoque



**Replaced by: / Sostituite da:
Ersetzt durch: / Remplacées par:
Substituidas por: / Substituído por:**



**Obtainable with: / Ottenibili con:
Realisierbar mit: / Réalisables avec:
Obtenibles con: / Conseguível com:**

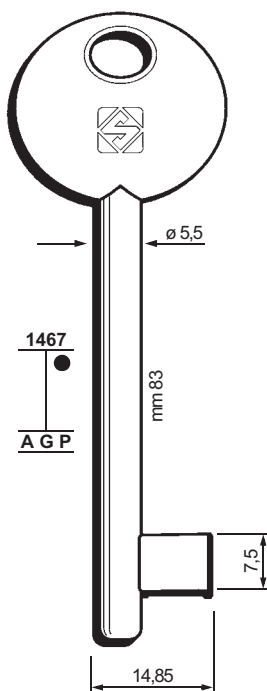

For/Per
BONAITI
2GBP
4GBP
6GBP
8GBP
10GBP
12GBP

For/Per
BONAITI
1GBP
3GBP
5GBP
7GBP
9GBP
11GBP

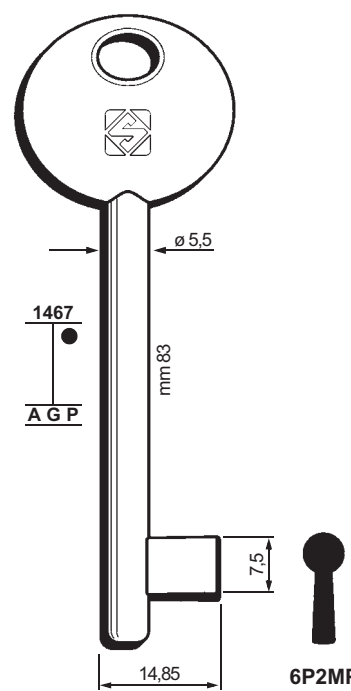

6P2MP

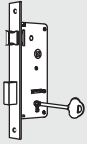

132

FOR:
PER:

BONAITI - "GB" \square 8

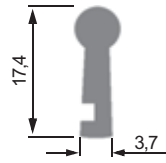
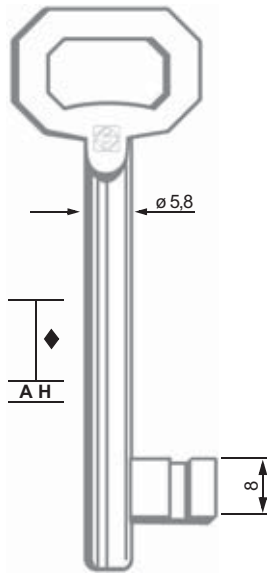

- | | | | | | |
|----------|----------|----------|-----------|-----------|-----------|
| 1
GBG | 2
GBG | 3
GBG | 4
GBG | 5
GBG | 6
GBG |
| 7
GBG | 8
GBG | 9
GBG | 10
GBG | 11
GBG | 12
GBG |



Chiavi obsolete non disponibili a stock - Obsolete keys not available from stock - Überholte Schlüssel, die nicht mehr auf Lager sind - Clés obsolètes non disponibles de stock - Llaves obsoletas no disponibles en stock - Chaves antigas não disponíveis no estoque



Replaced by: / Sostituite da:
Ersetzt durch: / Remplacées par:
Substituidas por: / Substituído por:

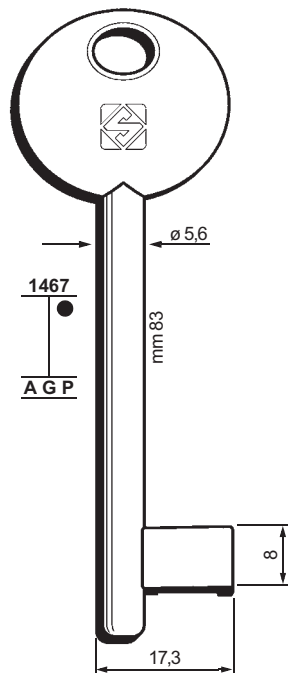

6P3D

For/Per	BONAITI
	2GBG
	4GBG
	6GBG
	8GBG
	10GBG
	12GBG



6P3S

For/Per	BONAITI
	1GBG
	3GBG
	5GBG
	7GBG
	9GBG
	11GBG



133

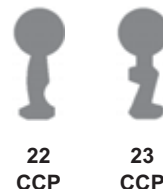
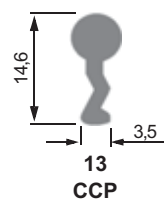
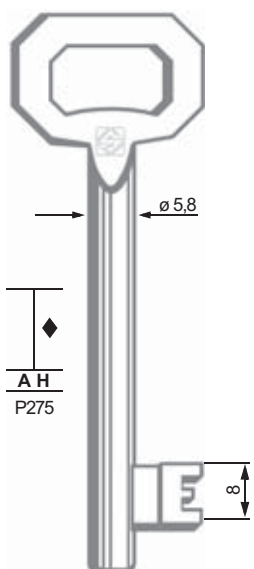
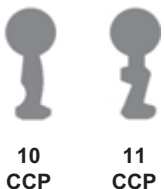
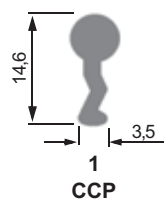
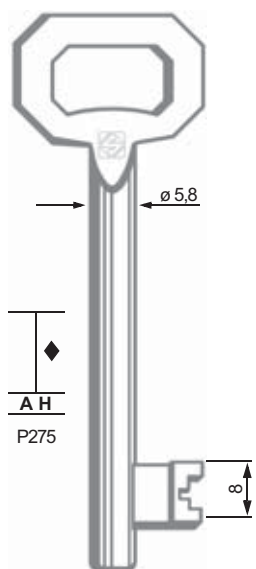

Chiavi obsolete non disponibili a stock - Obsolete keys not available from stock - Überholte Schlüssel, die nicht mehr auf Lager sind - Clés obsolètes non disponibles de stock - Llaves obsoletas no disponibles en stock - Chaves antigas não disponíveis no estoque



Replaced by: / Sostituite da:
Ersetzt durch: / Remplacées par:
Substituidas por: / Substituído por:

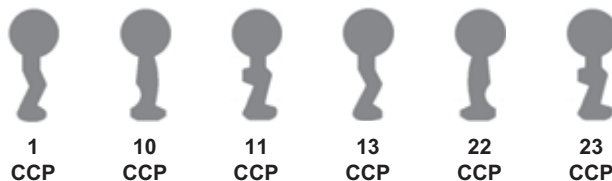
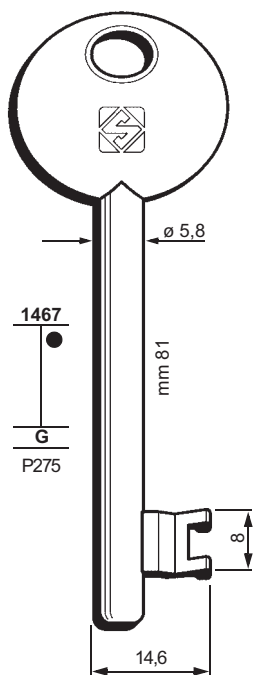

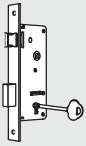

134

FOR:
PER:

CORNI  6

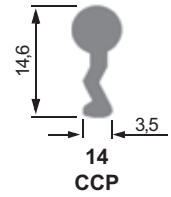
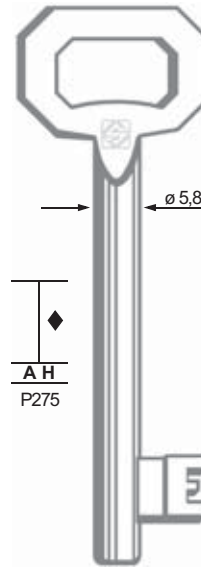
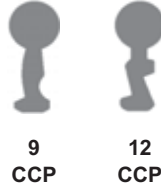
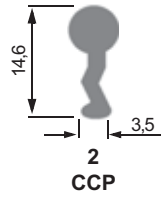
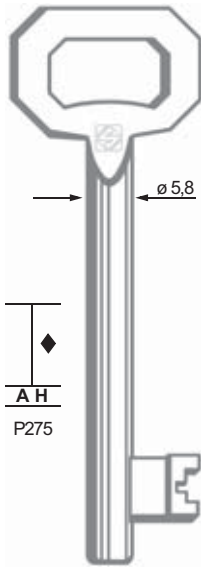

Chiavi obsolete non disponibili a stock - Obsolete keys not available from stock - Überholte Schlüssel, die nicht mehr auf Lager sind - Clés obsolètes non disponibles de stock - Llaves obsoletas no disponibles en stock - Chaves antigas não disponíveis no estoque



Replaced by: / Sostituite da:
Ersetzt durch: / Remplacées par:
Substituidas por: / Substituído por:

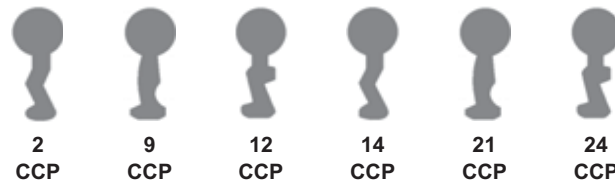
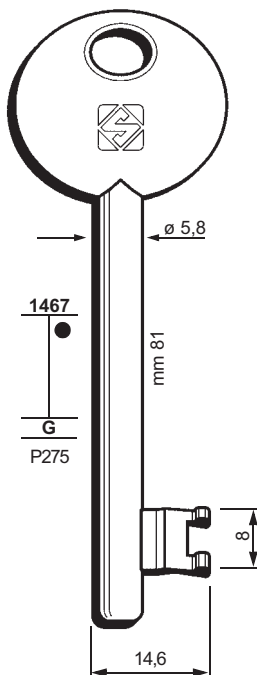



135

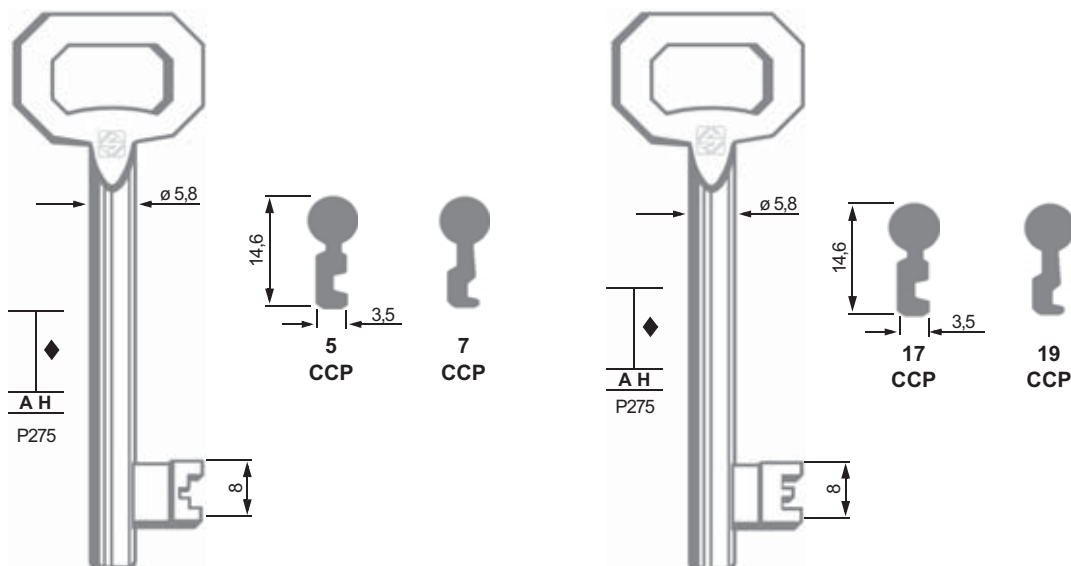

Chiavi obsolete non disponibili a stock - Obsolete keys not available from stock - Überholte Schlüssel, die nicht mehr auf Lager sind - Clés obsolètes non disponibles de stock - Llaves obsoletas no disponibles en stock - Chaves antigas não disponíveis no estoque



Replaced by: / Sostituite da:
Ersetzt durch: / Remplacées par:
Substituidas por: / Substituído por:

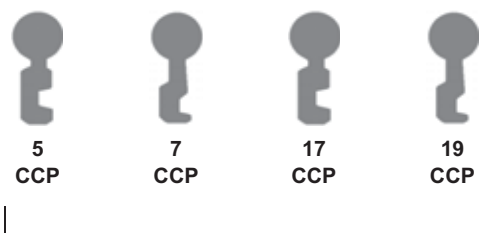
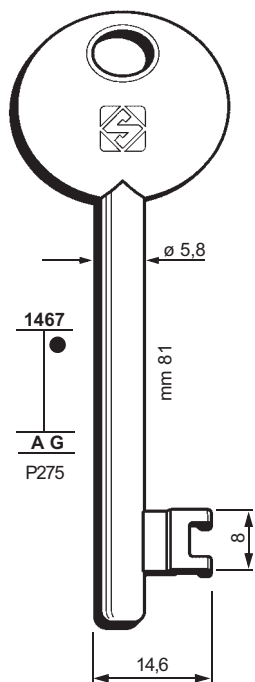

6P10D-1

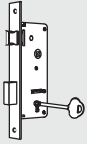

FOR:
PER:

CORNI  6

136

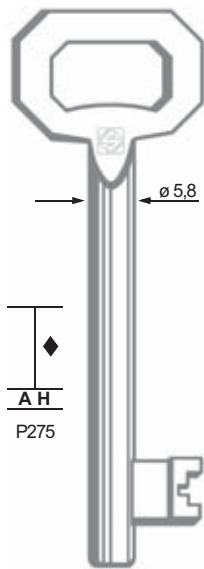

A H
P275

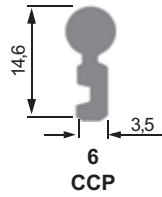

6
CCP



8
CCP

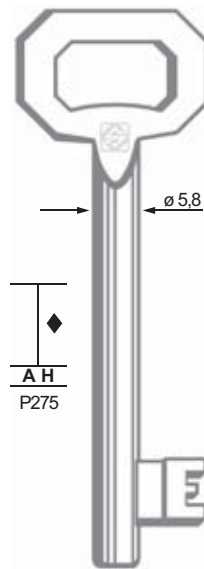

A H
P275

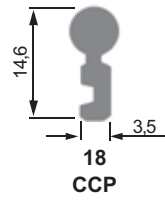

18
CCP



20
CCP



Chiavi obsolete non disponibili a stock - Obsolete keys not available from stock - Überholte Schlüssel, die nicht mehr auf Lager sind - Clés obsolètes non disponibles de stock - Llaves obsoletas no disponibles en stock - Chaves antigas não disponíveis no estoque



Replaced by: / Sostituite da:
Ersetzt durch: / Remplacées par:
Substituidas por: / Substituído por:

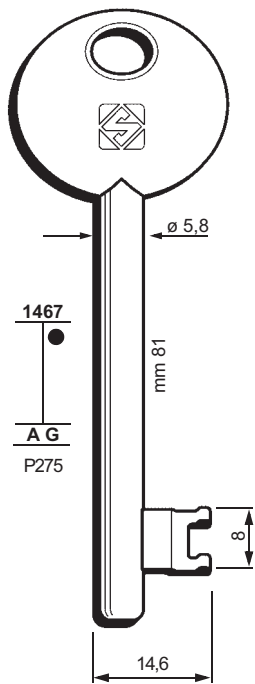

1467
A G
P275

mm 81

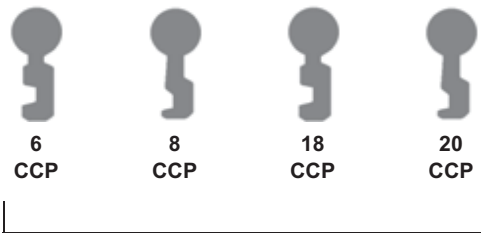

6P10S-1



137

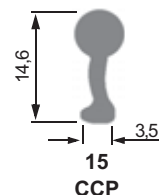
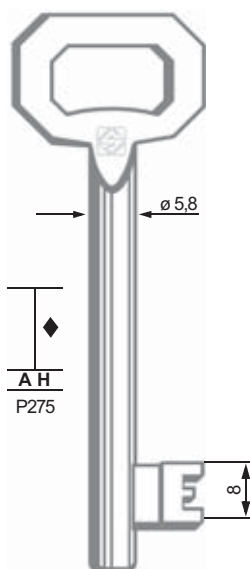
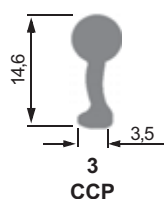
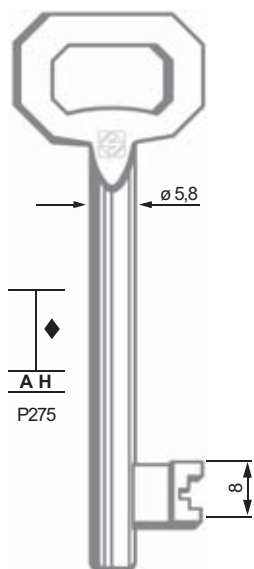

Chiavi obsolete non disponibili a stock - Obsolete keys not available from stock - Überholte Schlüssel, die nicht mehr auf Lager sind - Clés obsolètes non disponibles de stock - Llaves obsoletas no disponibles en stock - Chaves antigas não disponíveis no estoque



Replaced by: / Sostituite da:
Ersetzt durch: / Remplacées par:
Substituidas por: / Substituído por:

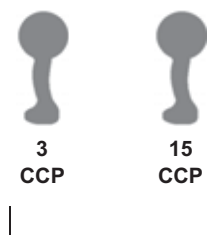
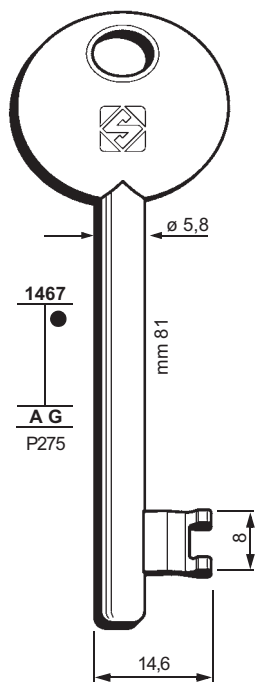

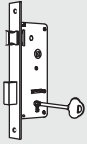

138

FOR:
PER:

CORNI \square 6

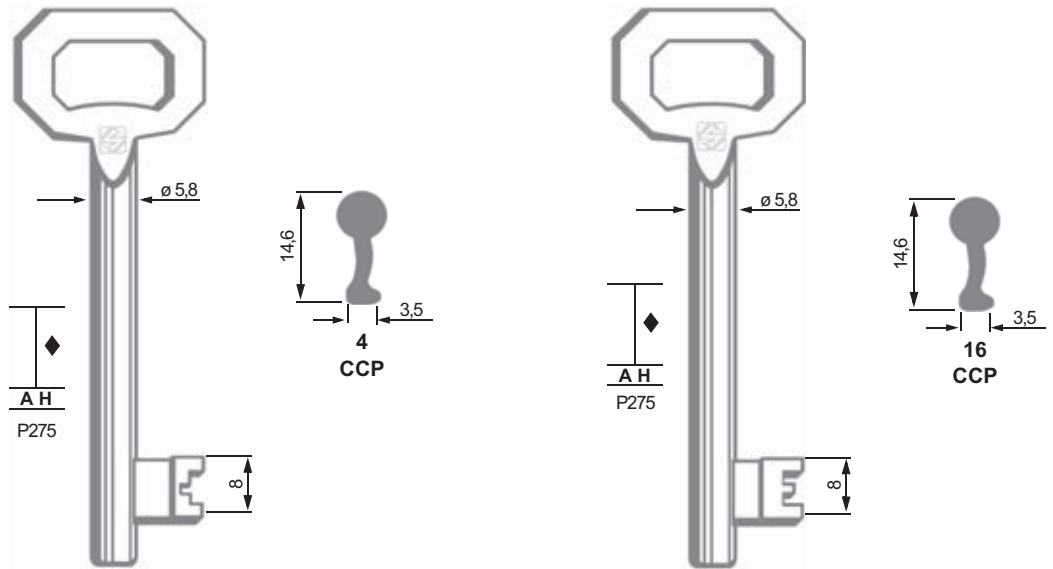

Chiavi obsolete non disponibili a stock - Obsolete keys not available from stock - Überholte Schlüssel, die nicht mehr auf Lager sind - Clés obsolètes non disponibles de stock - Llaves obsoletas no disponibles en stock - Chaves antigas não disponíveis no estoque

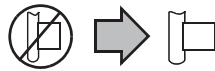

Replaced by: / Sostituite da:
Ersetzt durch: / Remplacées par:
Substituidas por: / Substituído por:

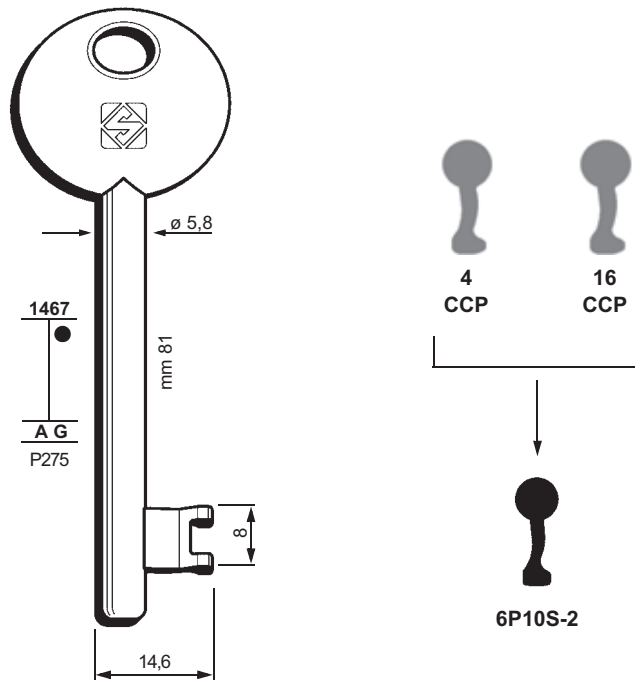

FOR:
PER:

CORNI  8



139

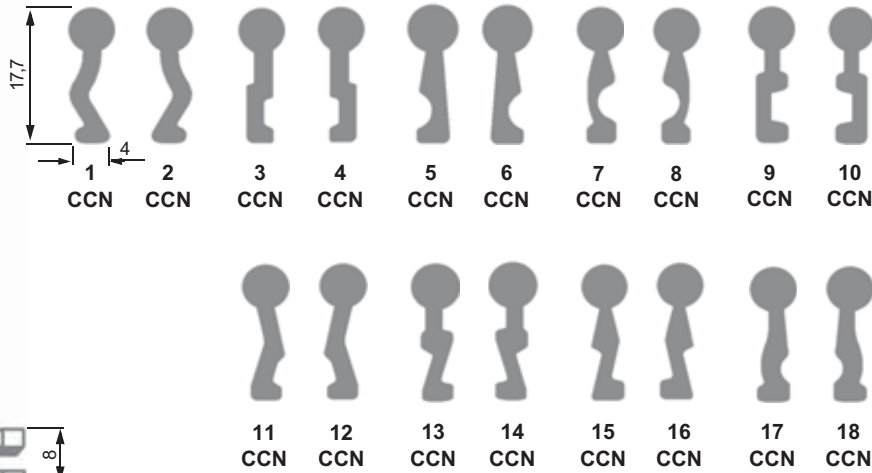
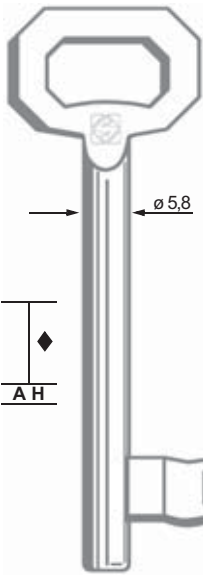

A H



Chiavi obsolete non disponibili a stock - Obsolete keys not available from stock - Überholte Schlüssel, die nicht mehr auf Lager sind - Clés obsolètes non disponibles de stock - Llaves obsoletas no disponibles en stock - Chaves antigas não disponíveis no estoque



Replaced by: / Sostituite da:
Ersetzt durch: / Remplacées par:
Substituidas por: / Substituído por:

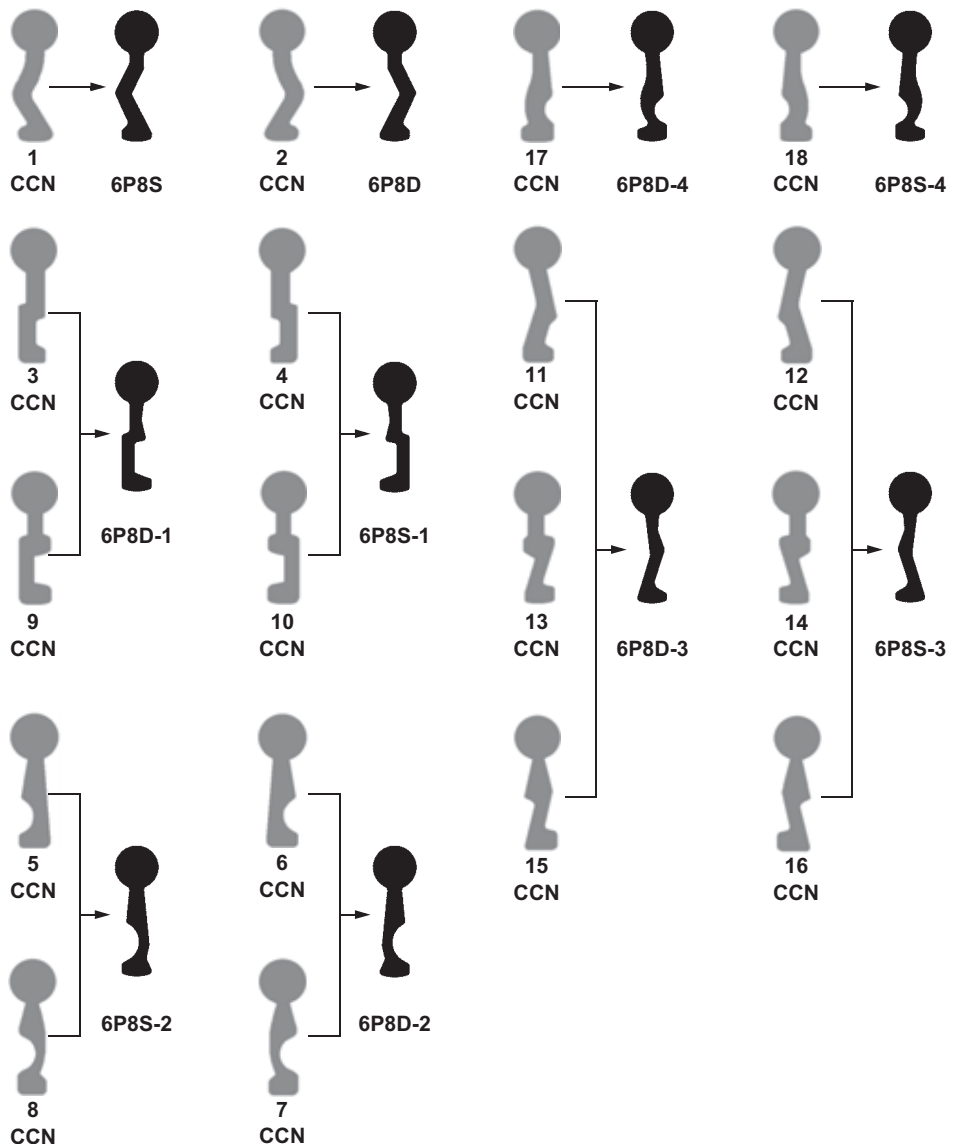
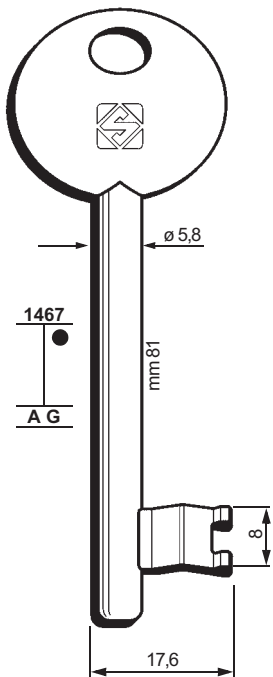



FOR:
PER:

CORNI  8

140

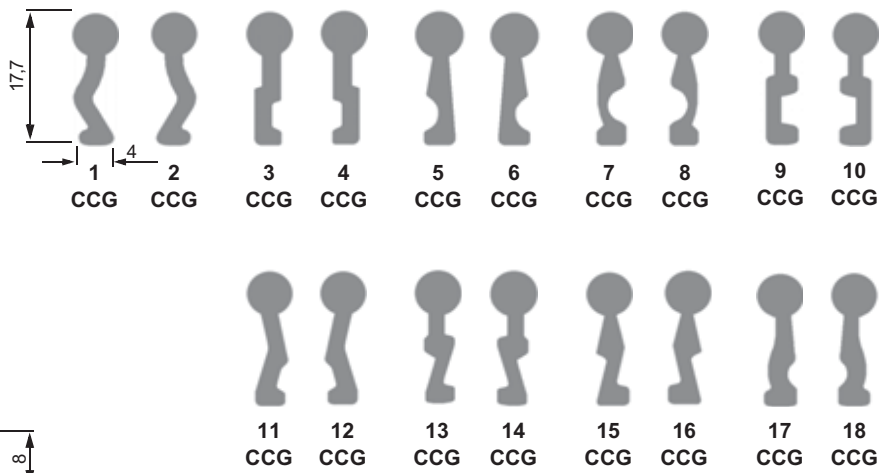
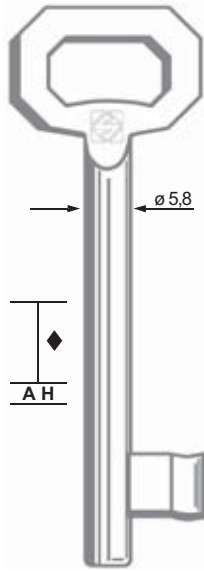

Chiavi obsolete non disponibili a stock - Obsolete keys not available from stock - Überholte Schlüssel, die nicht mehr auf Lager sind - Clés obsolètes non disponibles de stock - Llaves obsoletas no disponibles en stock - Chaves antigas não disponíveis no estoque

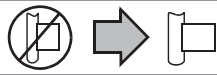

Replaced by: / Sostituite da:
Ersetzt durch: / Remplacées par:
Substituidas por: / Substituído por:

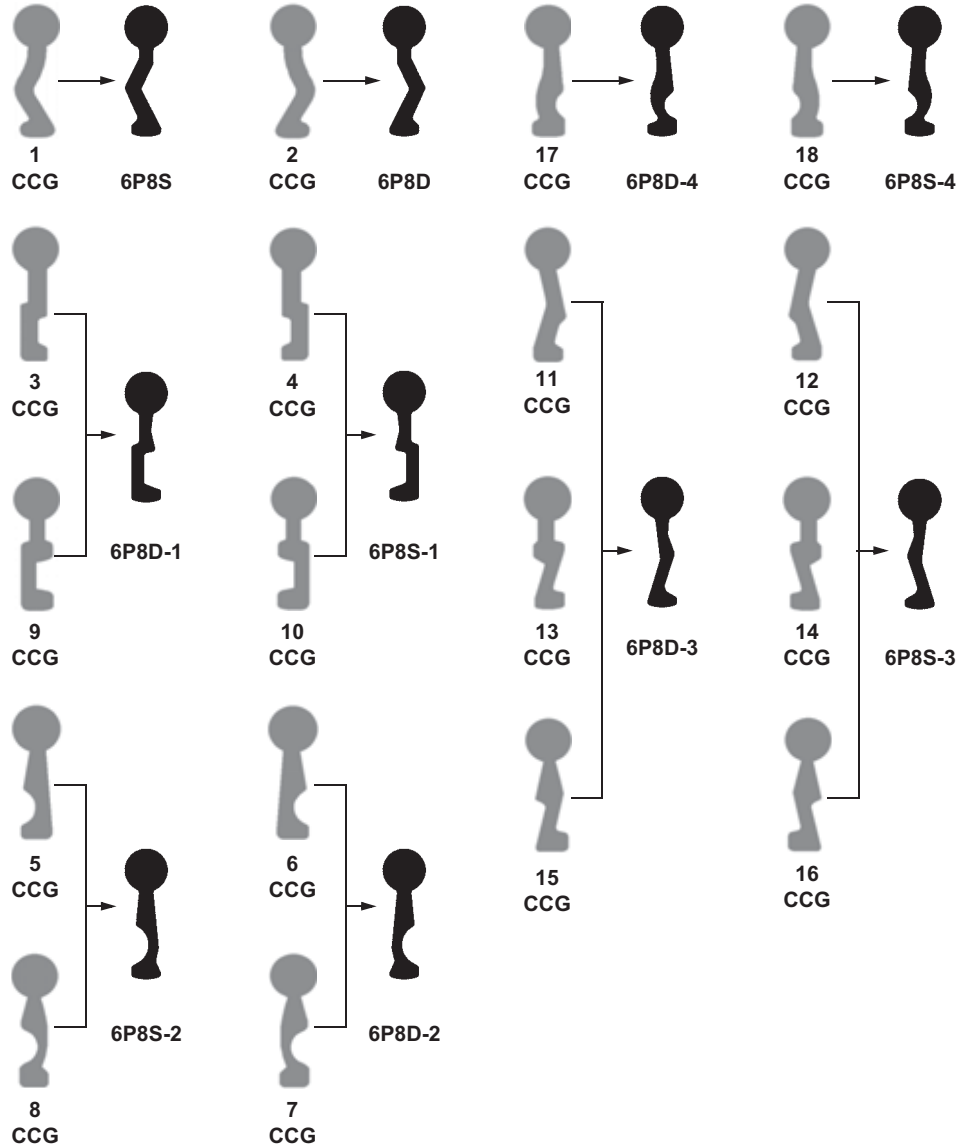
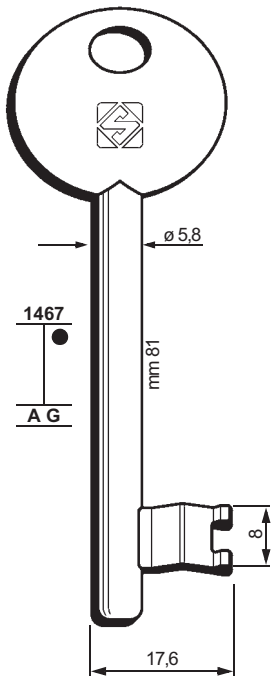

FOR:
PER:

CORNI  8

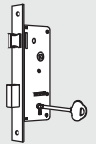

141

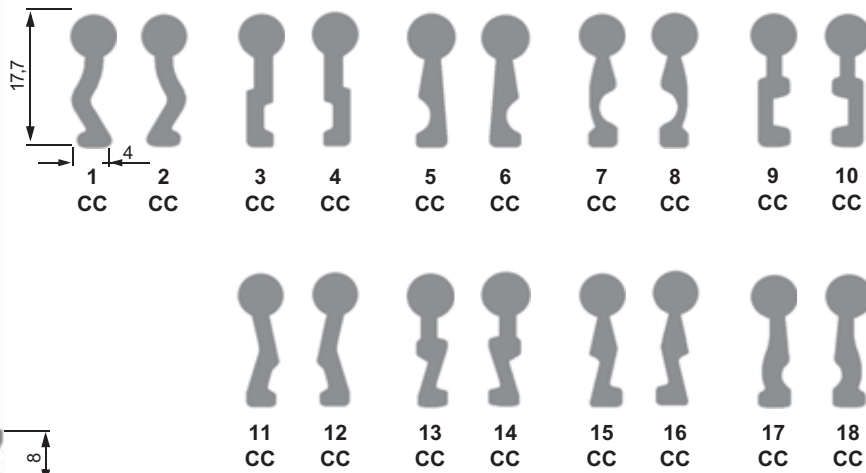
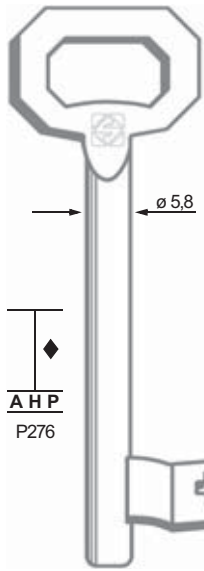

Chiavi obsolete non disponibili a stock - Obsolete keys not available from stock - Überholte Schlüssel, die nicht mehr auf Lager sind - Clés obsolètes non disponibles de stock - Llaves obsoletas no disponibles en stock - Chaves antigas não disponíveis no estoque



Replaced by: / Sostituite da:
Ersetzt durch: / Remplacées par:
Substituidas por: / Substituído por:

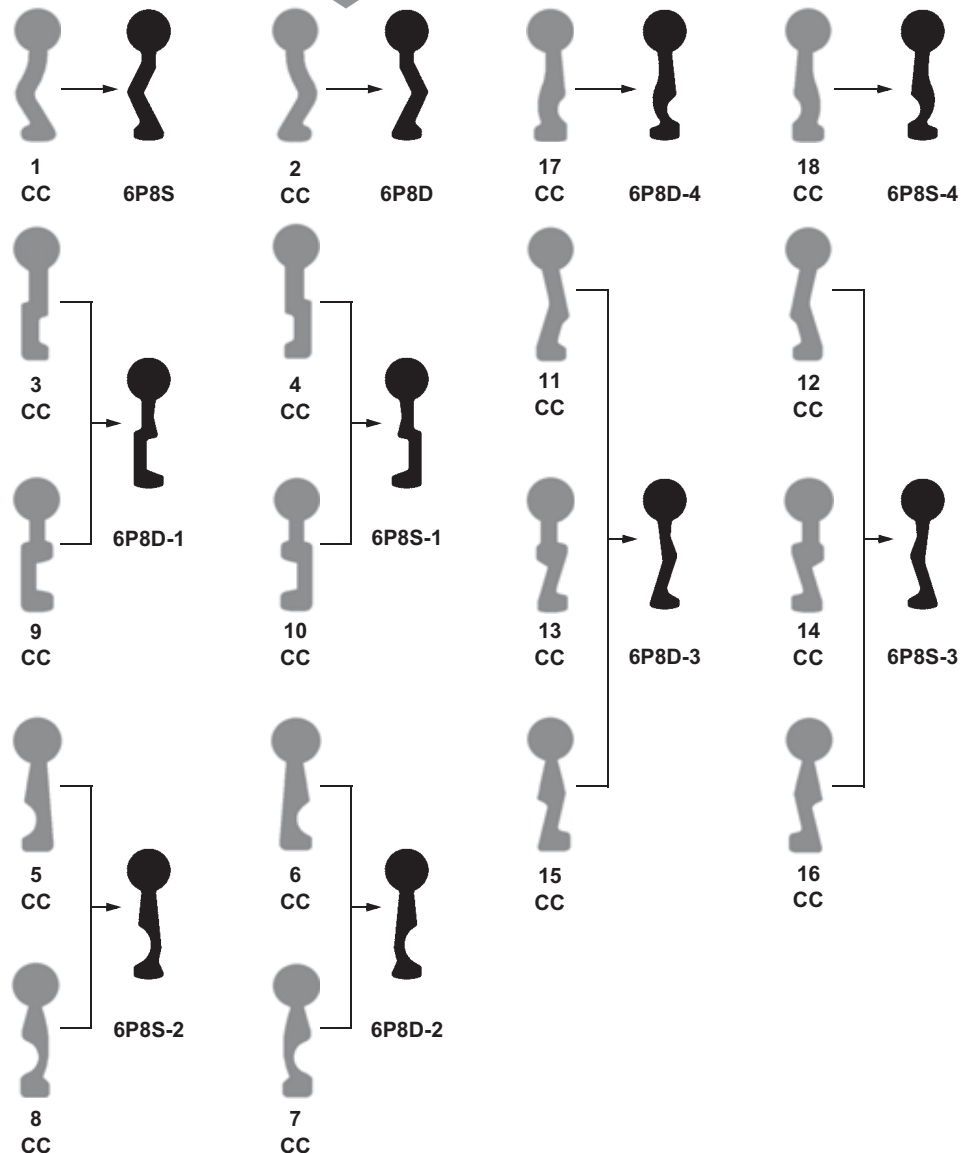
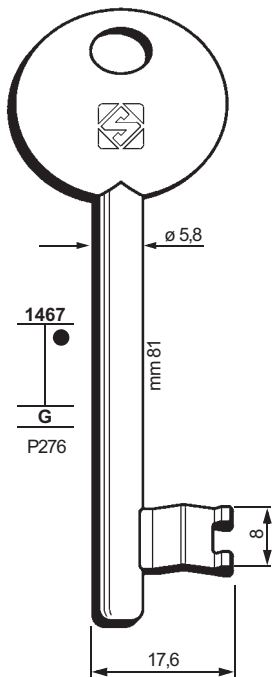



FOR:
PER:

CORNI 8

142

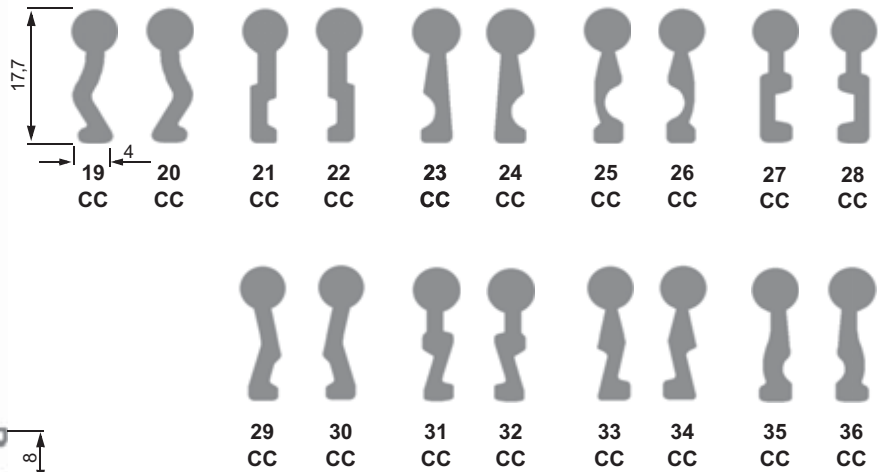
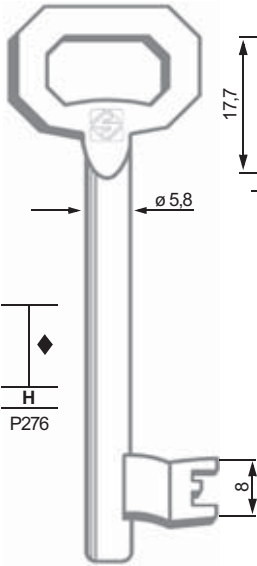

Chiavi obsolete non disponibili a stock - Obsolete keys not available from stock - Überholte Schlüssel, die nicht mehr auf Lager sind - Clés obsolètes non disponibles de stock - Llaves obsoletas no disponibles en stock - Chaves antigas não disponíveis no estoque



Replaced by: / Sostituite da:
Ersetzt durch: / Remplacées par:
Substituidas por: / Substituído por:

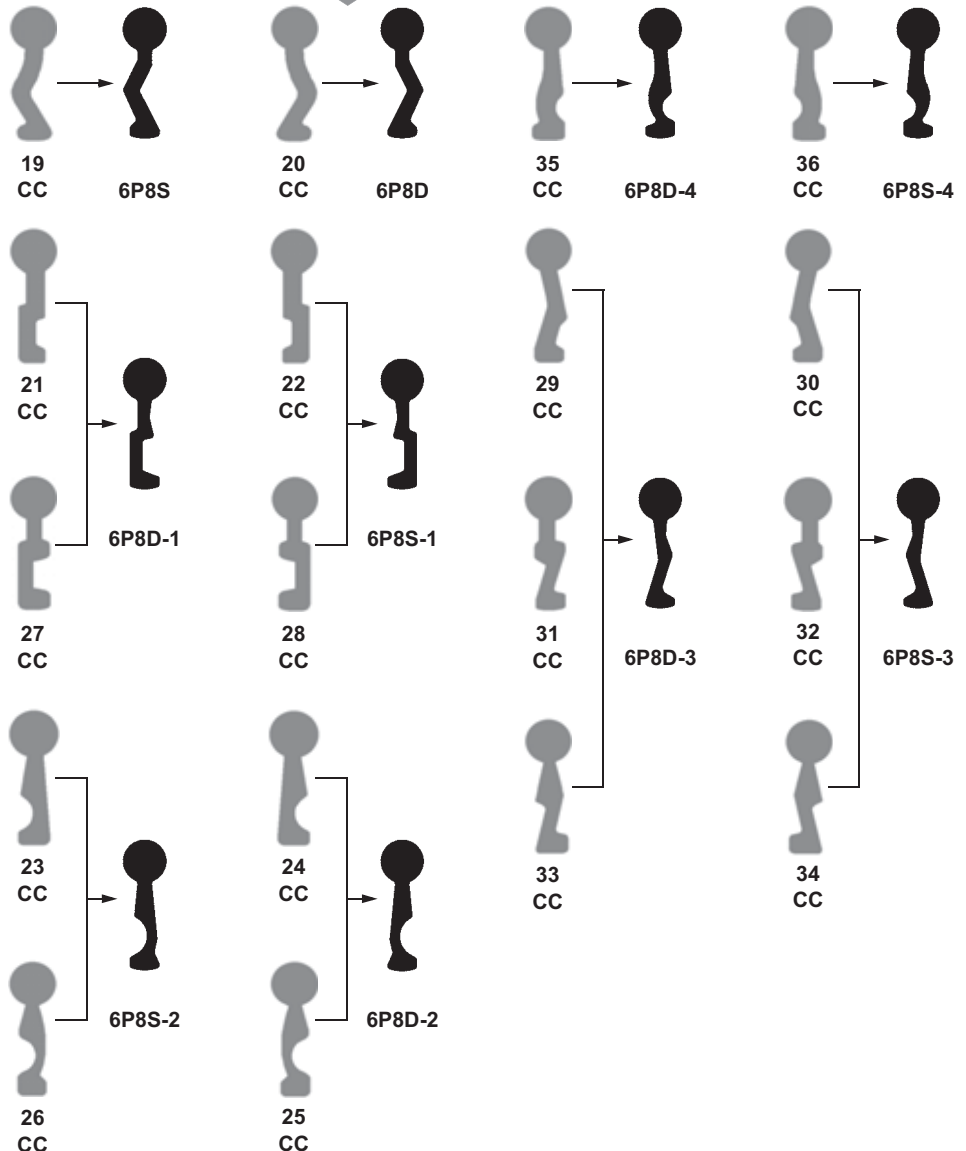
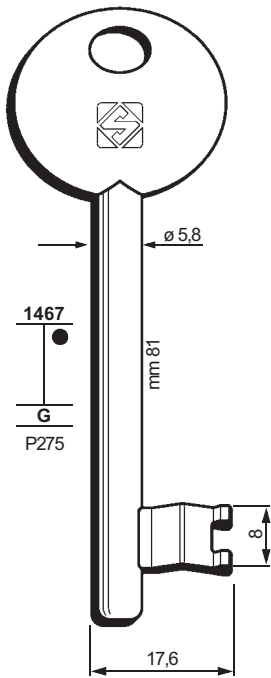









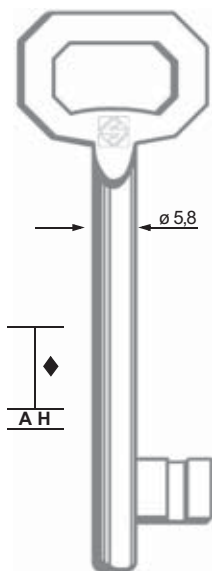

FOR:
PER:

CORNI  **8**



143



						
Art. Silca →	1 MPN	2 MPN	5 MPN	6 MPN	7 MPN	8 MPN
Corni orig. →	51	52	53	54	55	56
						
	9 MPN	10 MPN	11 MPN	12 MPN		
	57	58	59	60		



Chiavi obsolete non disponibili a stock - Obsolete keys not available from stock - Überholte Schlüssel, die nicht mehr auf Lager sind - Clés obsolètes non disponibles de stock - Llaves obsoletas no disponibles en stock - Chaves antigas não disponíveis no estoque



**Replaced by: / Sostituite da:
Ersetzt durch: / Remplacées par:
Substituidas por: / Substituído por:**



**Obtainable with: / Ottenibili con:
Realisierbar mit: / Réalisables avec:
Obtenibles con: / Conseguível com:**

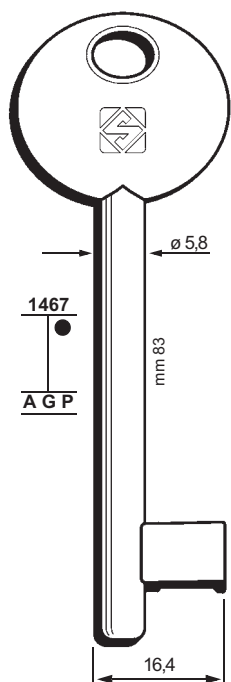

6P1D

For/Per	CORN
	1MPN
	5MPN
	7MPN
	9MPN
	11MPN

6P1S

For/Per	CORN
	2MPN
	6MPN
	8MPN
	10MPN
	12MPN

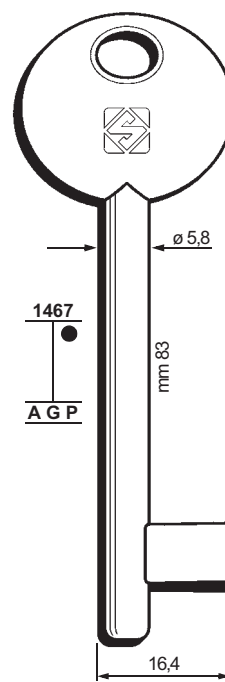

6P1MP

For/Per	CORN
	1MPN
	2MPN
	3MPN
	4MPN
	5MPN
	6MPN
	7MPN
	8MPN
	9MPN
	10MPN
	11MPN
	12MPN

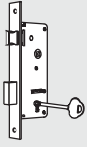

FOR:
PER:

DEBEAURAIN

144

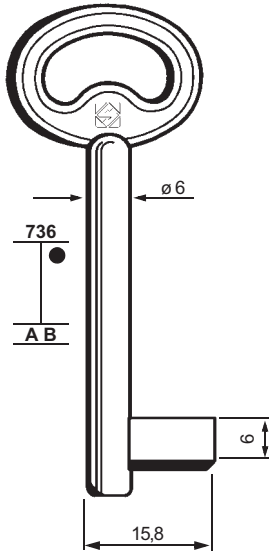

PER:
FOR:

EUREKA

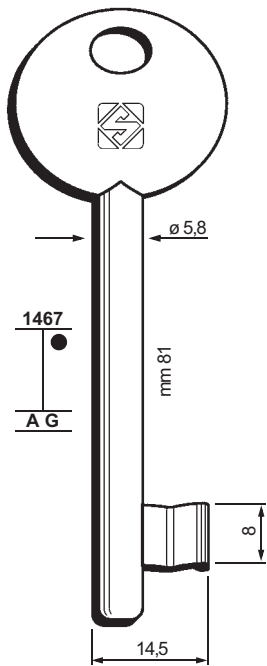

FOR:
PER:

GEGE

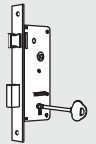

145

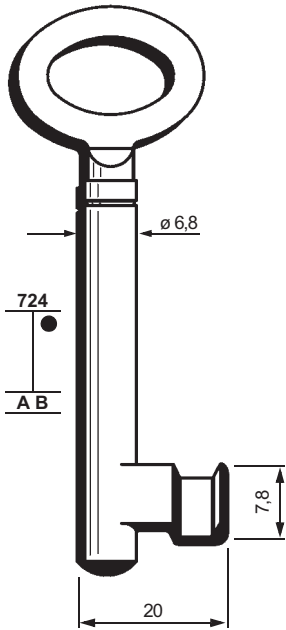

GE700-2



GE700-4



GE700-5



GE700-6



GE700-8



GE700-12



GE700-14



GE700-15



GE700-17



GE700-19



GE700-21



GE700-22



GE700-23



GE700-24



GE700-25



GE700-27



GE700-28



GE700-29



GE700-30



GE700-32



GE700-33



GE700-34



GE700-35



GE700-36



GE700-38



GE700-39



GE700-40



GE700-41



GE700-42



GE700-43



GE700-44



GE700-45



GE700-47



GE700-48



GE700-49



GE700-51



GE700-52



GE700-53



GE700-54



GE700-55



GE700-56



GE700-57



GE700-58



GE700-59



GE700-60

FOR:
PER:

LAPERCHE

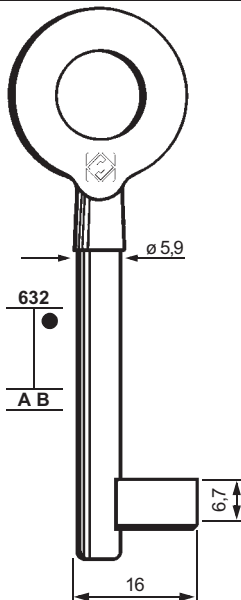

LH710L-3



LH710L-4



LH710L-5



LH710L-6



LH710L



LH710L-9



LH710L-10

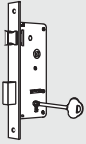

FOR:
PER:

MAVE

146

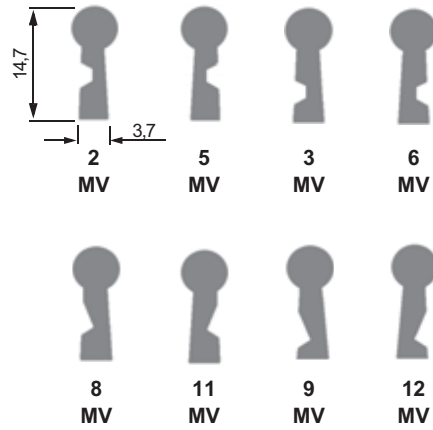
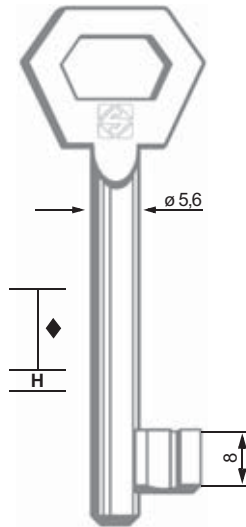

Chiavi obsolete non disponibili a stock - Obsolete keys not available from stock - Überholte Schlüssel, die nicht mehr auf Lager sind - Clés obsolètes non disponibles de stock - Llaves obsoletas no disponibles en stock - Chaves antigas não disponíveis no estoque

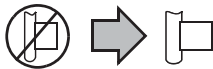

Replaced by: / Sostituite da:
Ersetzt durch: / Remplacées par:
Substituidas por: / Substituído por:

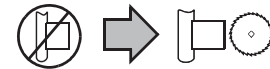

Obtainable with: / Ottenibili con:
Realisierbar mit: / Réalisables avec:
Obtenibles con: / Consequível com:

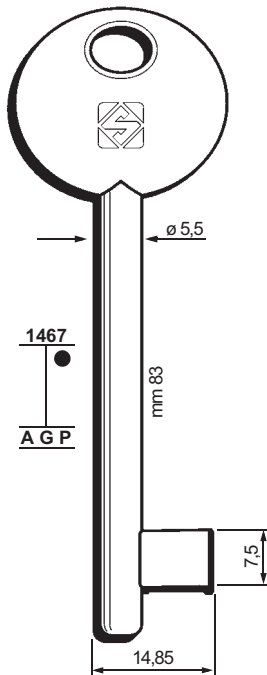

For/Per
MAVE
5MV
6MV
11MV
12MV



For/Per
MAVE
2MV
3MV
8MV
9MV

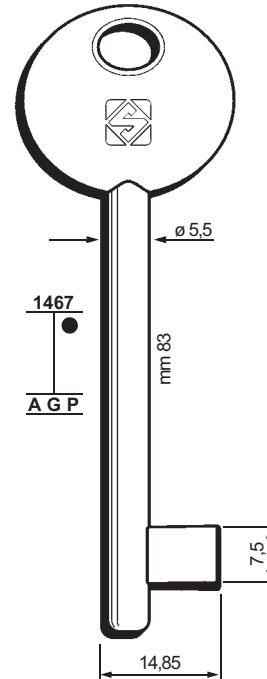

FOR:
PER:

MG - (MONTI per cancello)

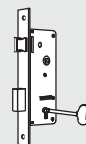

147

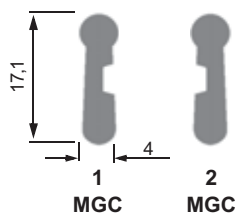
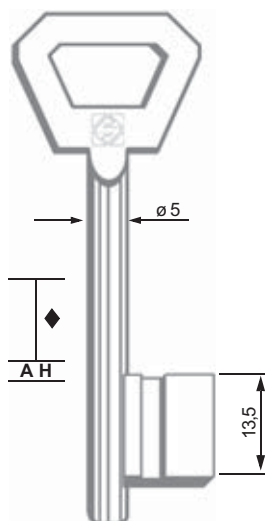

Chiavi obsolete non disponibili a stock - Obsolete keys not available from stock - Überholte Schlüssel, die nicht mehr auf Lager sind - Clés obsolètes non disponibles de stock - Llaves obsoletas no disponibles en stock - Chaves antigas não disponíveis no estoque



Obtainable with: / Ottenibili con:
Realisierbar mit: / Réalisables avec:
Obtenibles con: / Conseguível com:

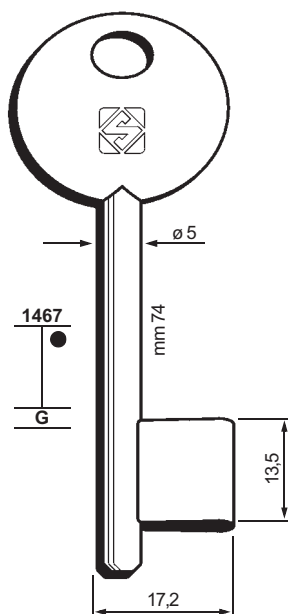

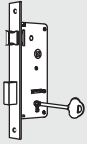

148

FOR:
PER:

MP

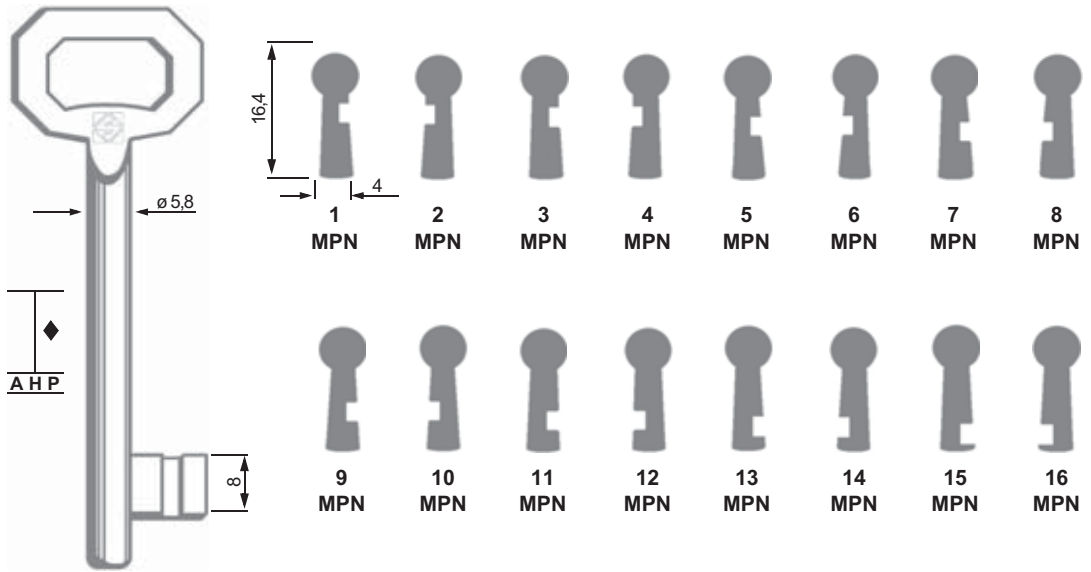

Chiavi obsolete non disponibili a stock - Obsolete keys not available from stock - Überholte Schlüssel, die nicht mehr auf Lager sind - Clés obsolètes non disponibles de stock - Llaves obsoletas no disponibles en stock - Chaves antigas não disponíveis no estoque

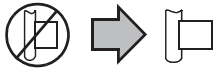

Replaced by: / Sostituite da:
Ersetzt durch: / Remplacées par:
Substituidas por: / Substituído por:



Obtainable with: / Ottenibili con:
Realisierbar mit: / Réalisables avec:
Obtenibles con: / Conseguível com:

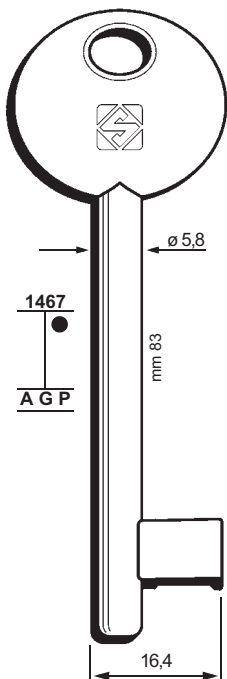

6P1D

For/Per
MP
1MPN
3MPN
5MPN
7MPN
9MPN
11MPN
13MPN
15MPN



6P1S

For/Per
MP
2MPN
4MPN
6MPN
8MPN
10MPN
12MPN
14MPN
16MPN

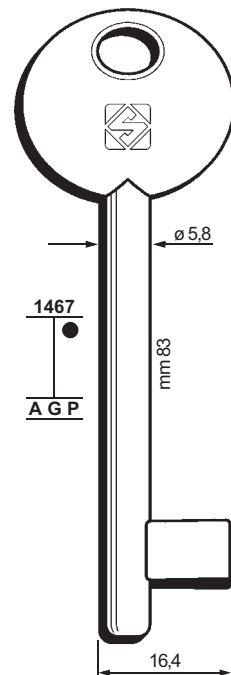

6P1MP

FOR:
PER:

MP

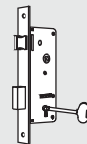

149

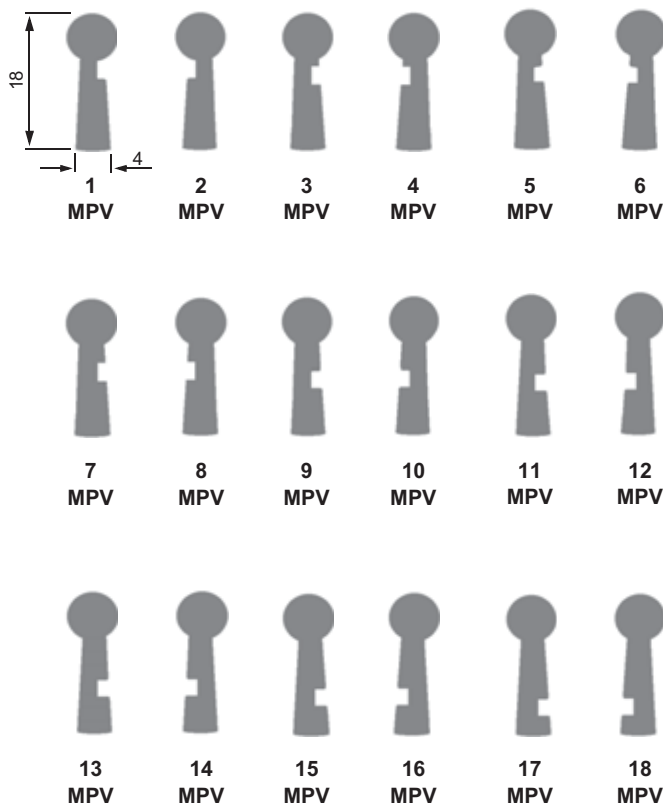
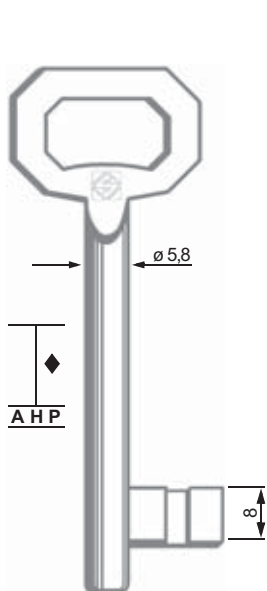

Chiavi obsolete non disponibili a stock - Obsolete keys not available from stock - Überholte Schlüssel, die nicht mehr auf Lager sind - Clés obsolètes non disponibles de stock - Llaves obsoletas no disponibles en stock - Chaves antigas não disponíveis no estoque



Replaced by: / Sostituite da:
Ersetzt durch: / Remplacées par:
Substituidas por: / Substituído por:



Obtainable with: / Ottenibili con:
Realisierbar mit: / Réalisables avec:
Obtenibles con: / Conseguível com:

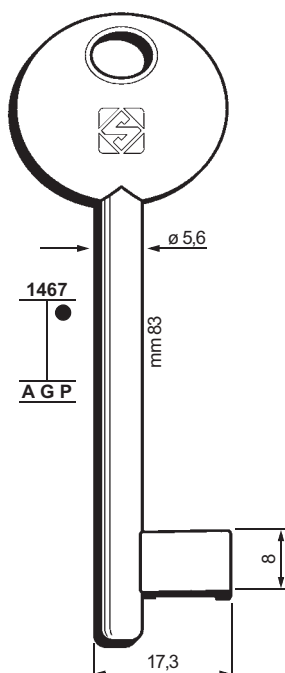

For/Per	MPV
1MPV	
3MPV	
5MPV	
7MPV	
9MPV	
11MPV	
13MPV	
15MPV	
17MPV	

For/Per	MPV
2MPV	
4MPV	
6MPV	
8MPV	
10MPV	
12MPV	
14MPV	
16MPV	
18MPV	

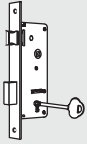

150

FOR:
PER:

MP 4 LEVE

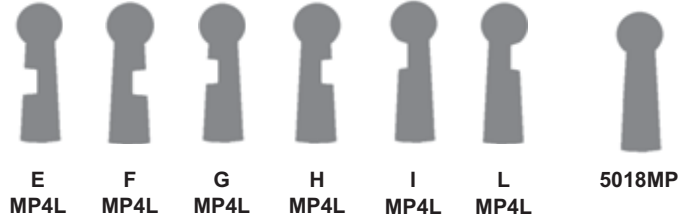
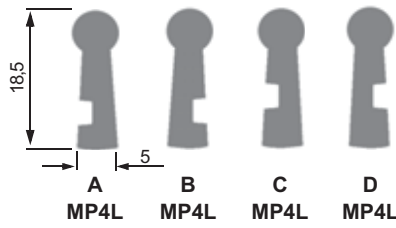
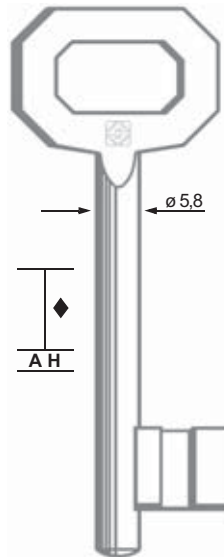

Chiavi obsolete non disponibili a stock - Obsolete keys not available from stock - Überholte Schlüssel, die nicht mehr auf Lager sind - Clés obsolètes non disponibles de stock - Llaves obsoletas no disponibles en stock - Chaves antigas não disponíveis no estoque

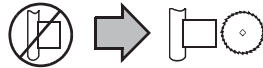

Obtainable with: / Ottenibili con:
Realisierbar mit: / Réalisables avec:
Obtenibles con: / Conseguível com:

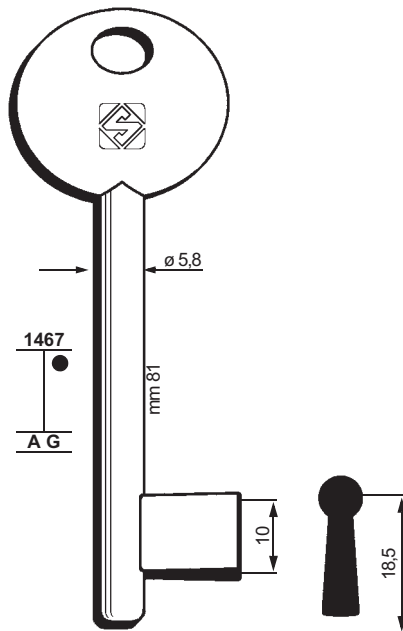

6P9MP

FOR:
PER:

NEMEF

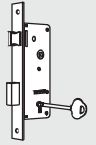

151

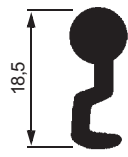
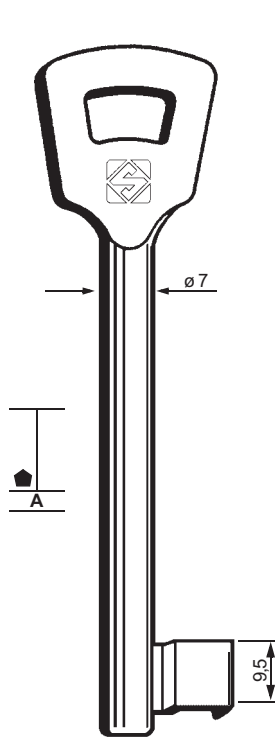

1
NFHL



2
NFHL



3
NFHL



4
NFHL



5
NFHL



6
NFHL



7
NFHL



8
NFHL



9
NFHL



10
NFHL

FOR:
PER:

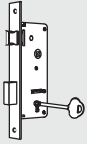

152

FOR:
PER:

OASA

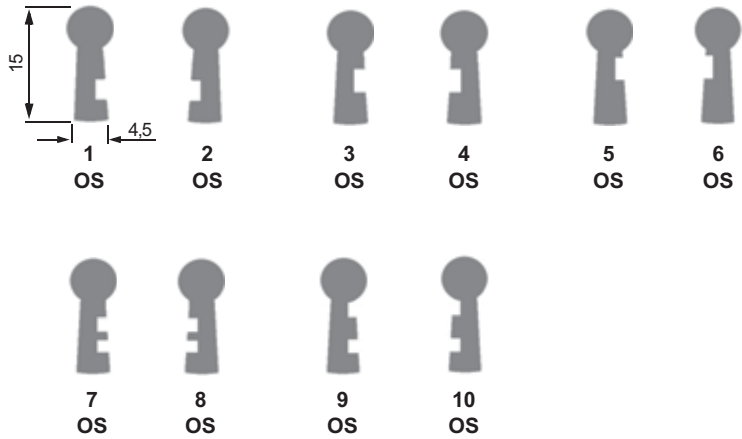
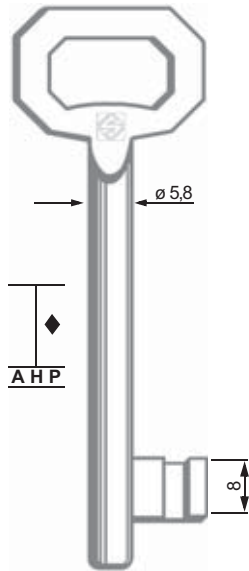

Chiavi obsolete non disponibili a stock - Obsolete keys not available from stock - Überholte Schlüssel, die nicht mehr auf Lager sind - Clés obsolètes non disponibles de stock - Llaves obsoletas no disponibles en stock - Chaves antigas não disponíveis no estoque

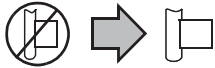

Replaced by: / Sostituite da:
Ersetzt durch: / Remplacées par:
Substituidas por: / Substituído por:

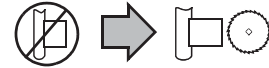

Obtainable with: / Ottenibili con:
Realisierbar mit: / Réalisables avec:
Obtenibles con: / Consequível com:

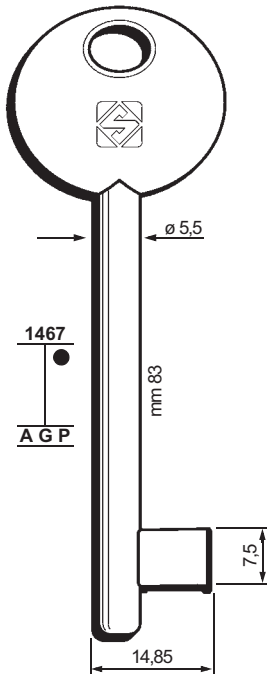

For/Per
OASA
10S
30S
50S
70S
90S



For/Per
OASA
20S
40S
60S
80S
100S

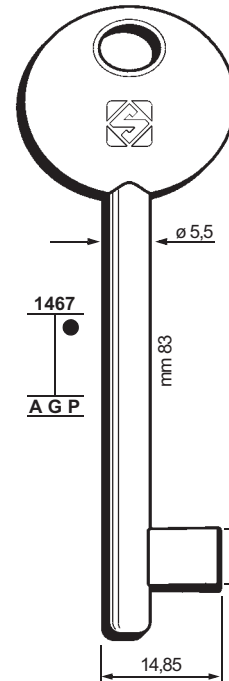

FOR:
PER:

OSMET

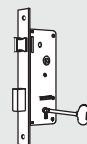

153

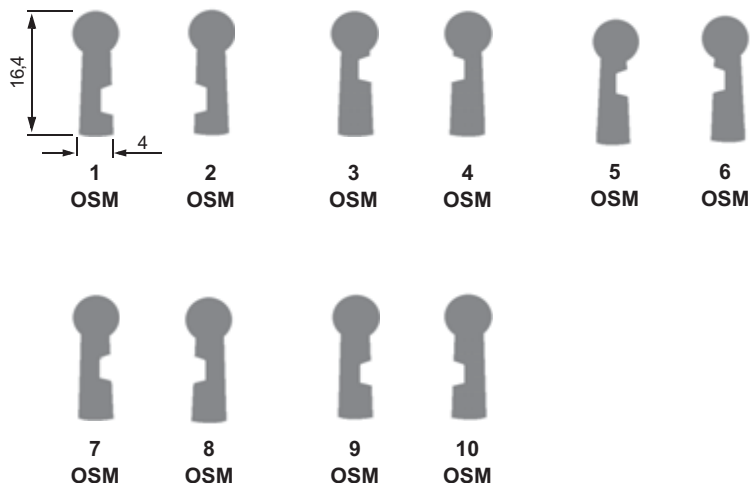
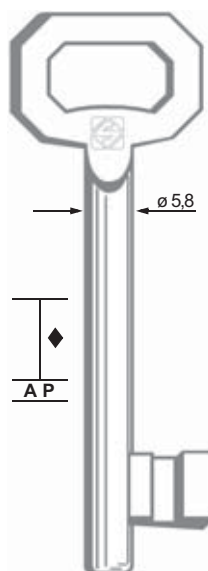

Chiavi obsolete non disponibili a stock - Obsolete keys not available from stock - Überholte Schlüssel, die nicht mehr auf Lager sind - Clés obsolètes non disponibles de stock - Llaves obsoletas no disponibles en stock - Chaves antigas não disponíveis no estoque



Obtainable with: / Ottenibili con:
Realisierbar mit: / Réalisables avec:
Obtenibles con: / Conseguível com:

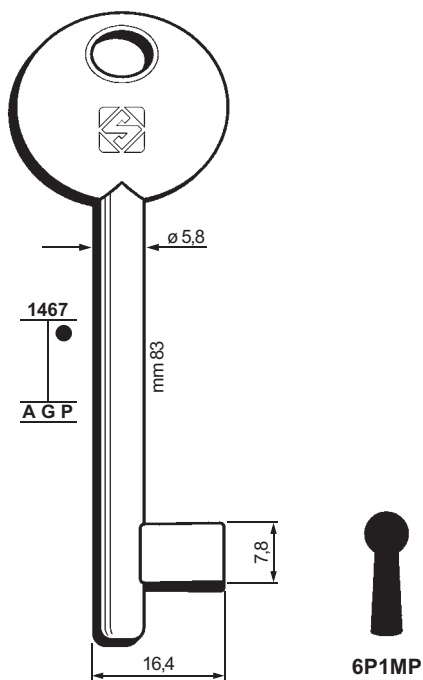

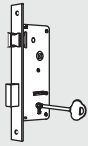

154

FOR:
PER:

PERINO 6

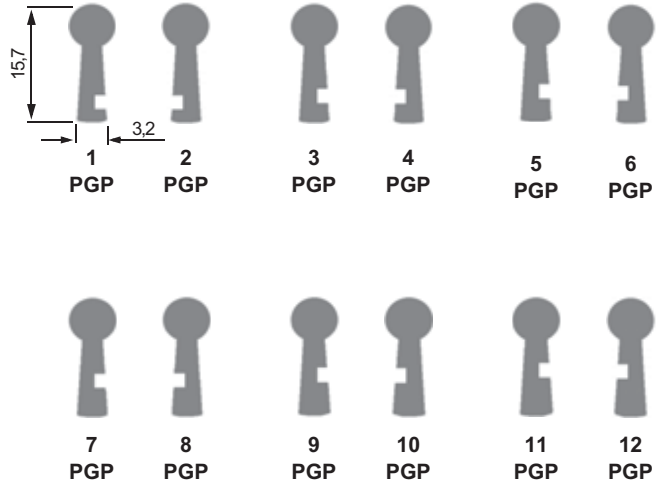
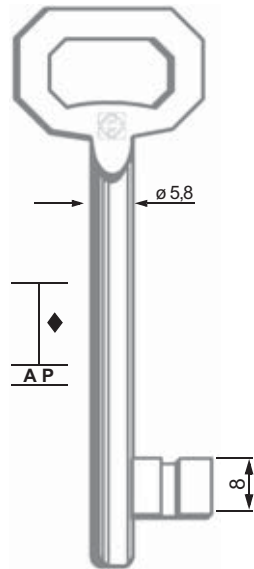

Chiavi obsolete non disponibili a stock - Obsolete keys not available from stock - Überholte Schlüssel, die nicht mehr auf Lager sind - Clés obsolètes non disponibles de stock - Llaves obsoletas no disponibles en stock - Chaves antigas não disponíveis no estoque

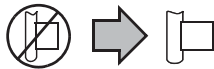

Replaced by: / Sostituite da:
Ersetzt durch: / Remplacées par:
Substituidas por: / Substituído por:

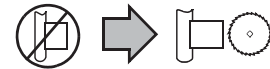

Obtainable with: / Ottenibili con:
Realisierbar mit: / Réalisables avec:
Obtenibles con: / Consequível com:

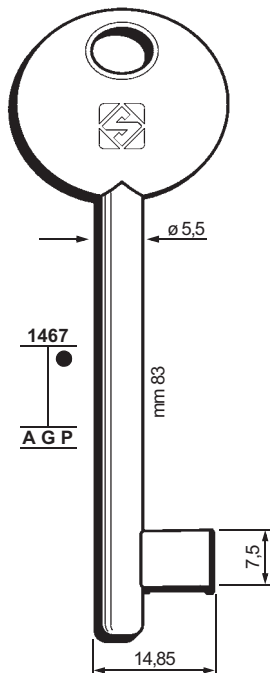

For/Per
PERINO
1PGP
3PGP
5PGP
7PGP
9PGP
11PGP

For/Per
PERINO
2PGP
4PGP
6PGP
8PGP
10PGP
12PGP

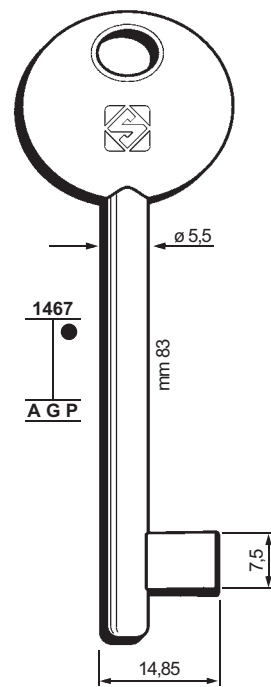

FOR:
PER:

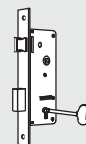

SINA

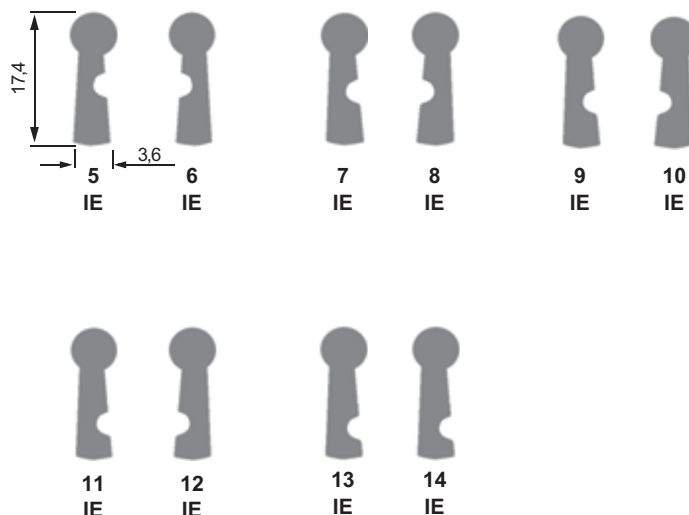
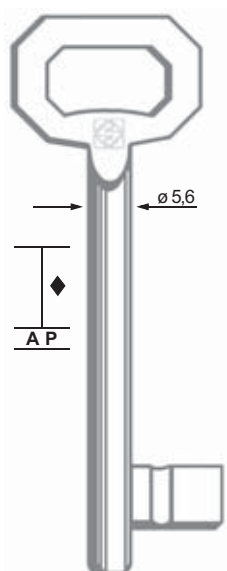

155



Chiavi obsolete non disponibili a stock - Obsolete keys not available from stock - Überholte Schlüssel, die nicht mehr auf Lager sind - Clés obsolètes non disponibles de stock - Llaves obsoletas no disponibles en stock - Chaves antigas não disponíveis no estoque

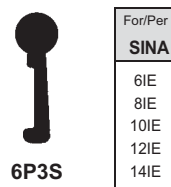
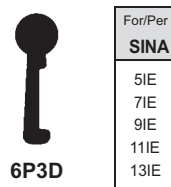
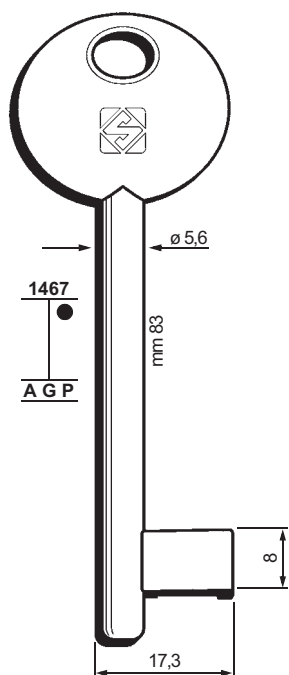

Replaced by: / Sostituite da:
Ersetzt durch: / Remplacées par:
Substituidas por: / Substituído por:

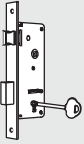



156

FOR:
PER:

SMT  8

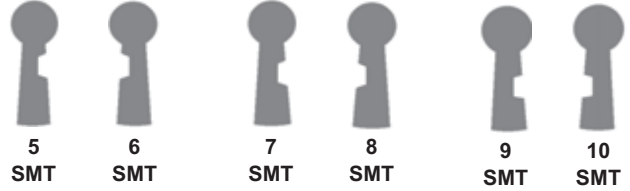
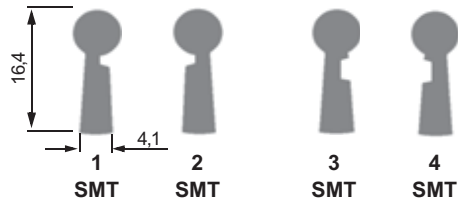
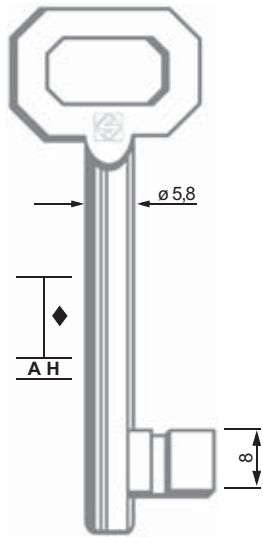

Chiavi obsolete non disponibili a stock - Obsolete keys not available from stock - Überholte Schlüssel, die nicht mehr auf Lager sind - Clés obsolètes non disponibles de stock - Llaves obsoletas no disponibles en stock - Chaves antigas não disponíveis no estoque



Obtainable with: / Ottenibili con:
Realisierbar mit: / Réalisables avec:
Obtenibles con: / Conseguível com:

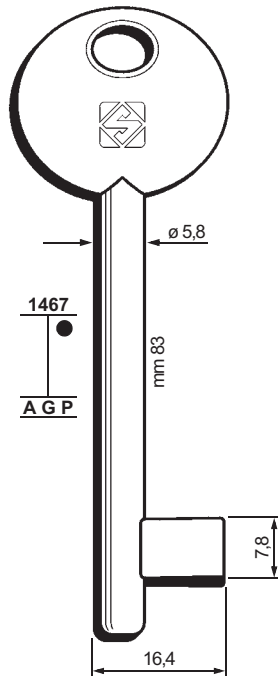

FOR:
PER:

STIQAM

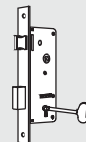

157

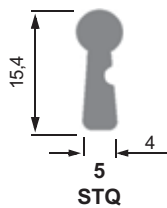
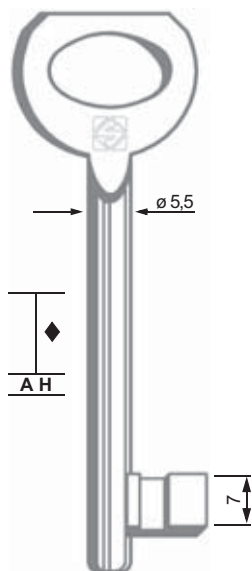

Chiavi obsolete non disponibili a stock - Obsolete keys not available from stock - Überholte Schlüssel, die nicht mehr auf Lager sind - Clés obsolètes non disponibles de stock - Llaves obsoletas no disponibles en stock - Chaves antigas não disponíveis no estoque



**Replaced by: / Sostituite da:
Ersetzt durch: / Remplacées par:
Substituidas por: / Substituído por:**



**Obtainable with: / Ottenibili con:
Realisierbar mit: / Réalisables avec:
Obtenibles con: / Consequível com:**

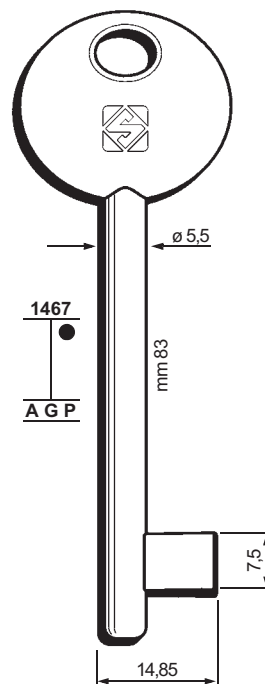
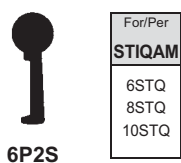
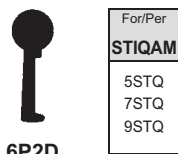
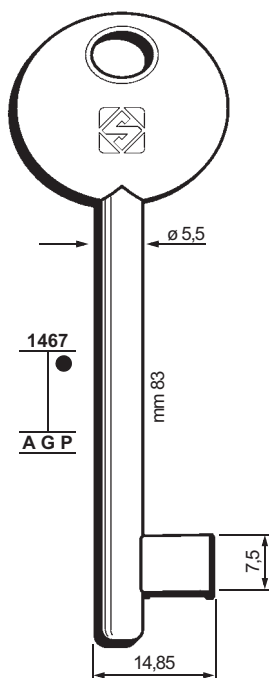

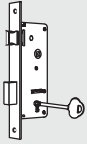

158

FOR:
PER:

PATENT "Passepartout"

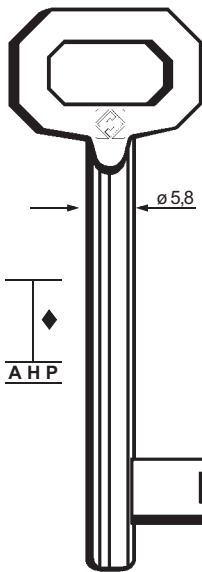

FOR/PER:
CORNI □ 8 (. . C)
(. . CCG)
(. . CCN)



5005C



5006C

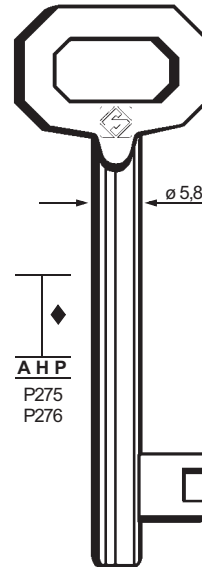

FOR/PER:
CORNI □ 6 (. . CCP)



5009

PER:
FOR:

PATENT "Passepartout"

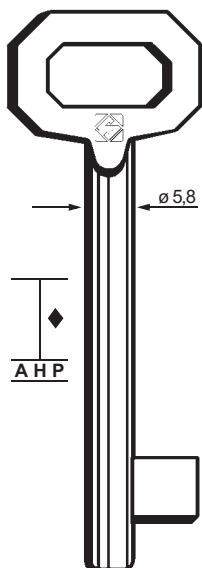

FOR/PER:
BONAITI (. . GBP)
ETNA (. . ET)
MAVE (. . MV)
MP (. . MPP)
OASA (. . OS)
PERINO (. . PGP)

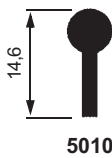

5010

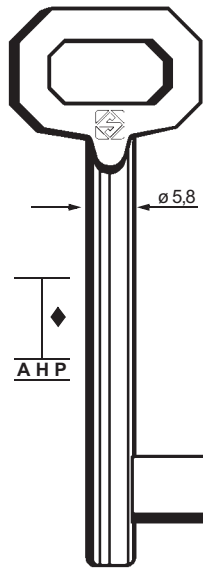

FOR/PER:
AGB (. . AGB)
MP (. . MPN)
PERINO (. . PG)
SMET (. . SM)

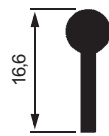

5011

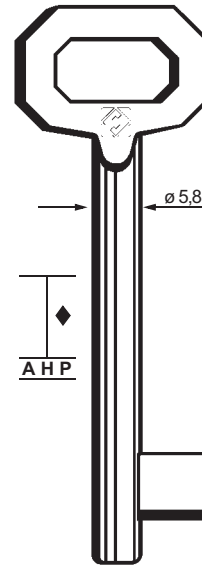

FOR/PER:
BONAITI (. . GBG)
ISEO (. . IE)
MP (. . MPV)

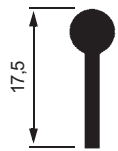

5012

FOR:
PER:

PATENT "Passepartout"

PATENT "tipo vecchio"

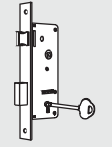

159

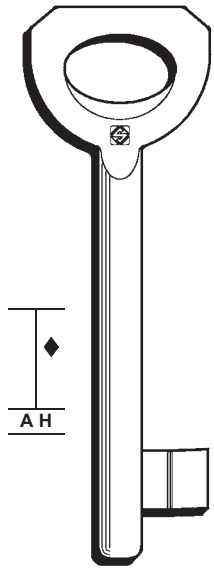

5008EK



5007EK

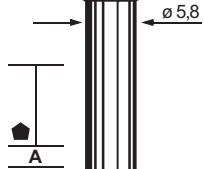
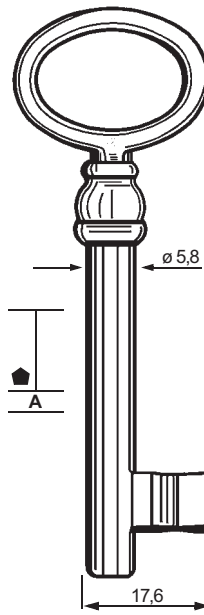

ø 5,8

17,6

7,6



07PV

08PV



13PV

14PV



09PV

10PV



17PV

18PV



15PV

16PV

FOR:
PER:

PATENT "mappa piena"

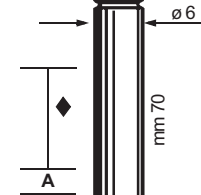
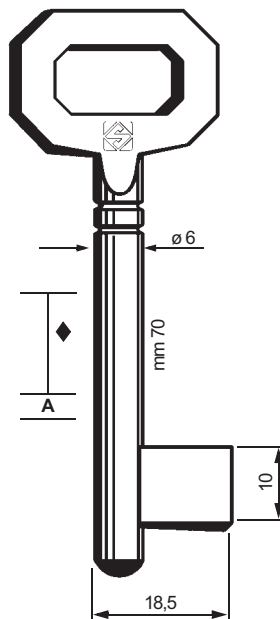

ø 6

mm 70

10

18,5



5602

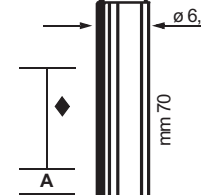
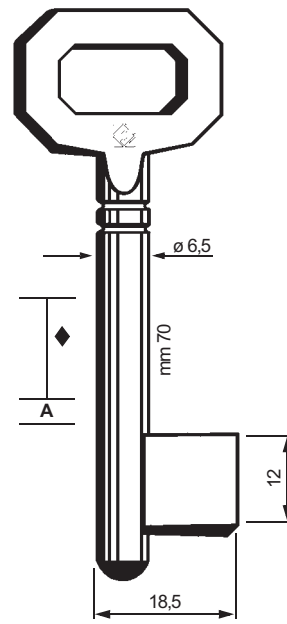

ø 6,5

mm 70

12

18,5



5601

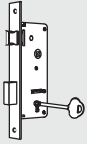

160

FOR:
PER:

PATENT "mappa piena"

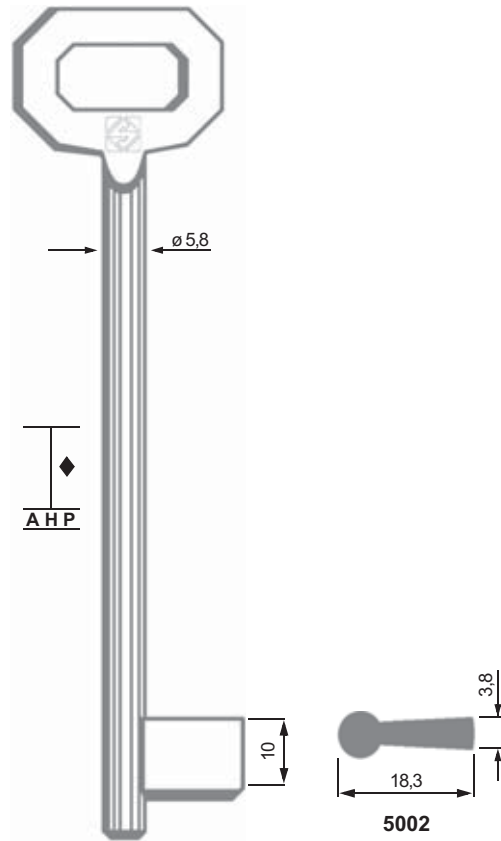

Chiavi obsolete non disponibili a stock - Obsolete keys not available from stock - Überholte Schlüssel, die nicht mehr auf Lager sind - Clés obsolètes non disponibles de stock - Llaves obsoletas no disponibles en stock - Chaves antigas não disponíveis no estoque



Replaced by: / Sostituite da:
Ersetzt durch: / Remplacées par:
Substituidas por: / Substituído por:

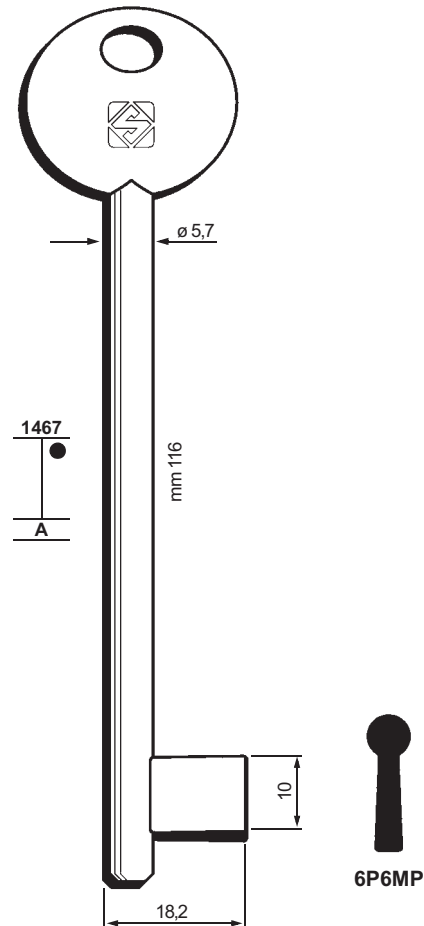

FOR:
PER:

Serrature da "CANTINA"

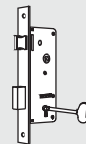

161

CORNI I

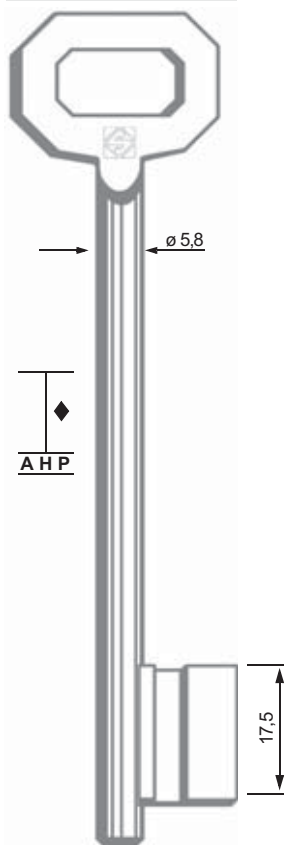

1
STC



3
STC



5
STC



7
STC



9
STC



11
STC



2
STC



4
STC



6
STC



8
STC



10
STC



12
STC



Chiavi obsolete non disponibili a stock - Obsolete keys not available from stock - Überholte Schlüssel, die nicht mehr auf Lager sind - Clés obsolètes non disponibles de stock - Llaves obsoletas no disponibles en stock - Chaves antigas não disponíveis no estoque



Replaced by: / Sostituite da:
Ersetzt durch: / Remplacées par:
Substituidas por: / Substituído por:

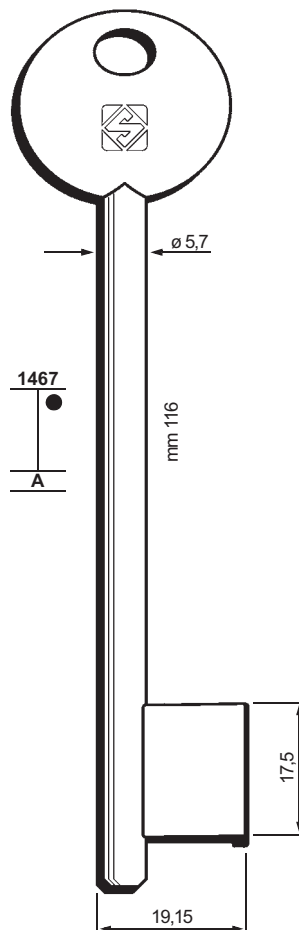

6P7D

For/Per	CORNI
	1STC
	3STC
	5STC
	7STC
	9STC
	11STC



6P7S

For/Per	CORNI
	2STC
	4STC
	6STC
	8STC
	10STC
	12STC

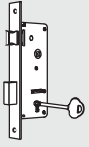

FOR:
PER:

Serrature "BRONZATE" e da "CANTINA LEGGERA"

162

BONAITI I

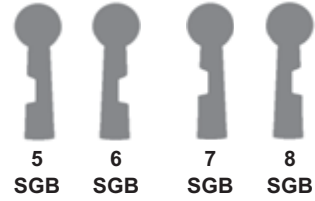
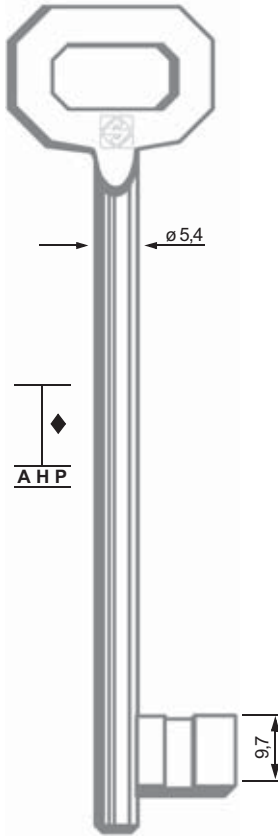

Chiavi obsolete non disponibili a stock - Obsolete keys not available from stock - Überholte Schlüssel, die nicht mehr auf Lager sind - Clés obsolètes non disponibles de stock - Llaves obsoletas no disponibles en stock - Chaves antigas não disponíveis no estoque

Obtainable with: / Ottenibili con:
Realisierbar mit: / Réalisables avec:
Obtenibles con: / Conseguível com:

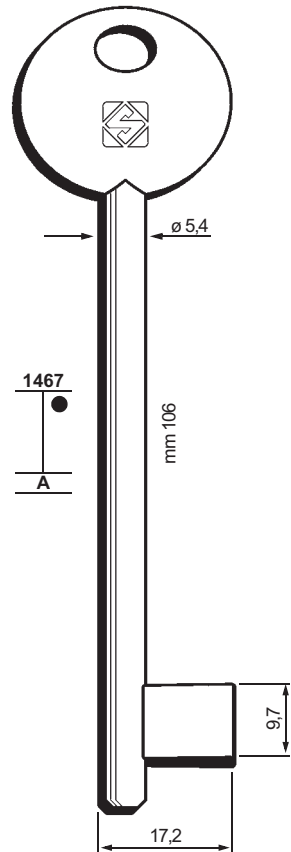

FOR:
PER:

Serrature "BRONZATE" e da "CANTINA LEGGERA"

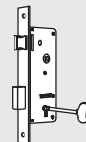

163

MP-CORNI (I)

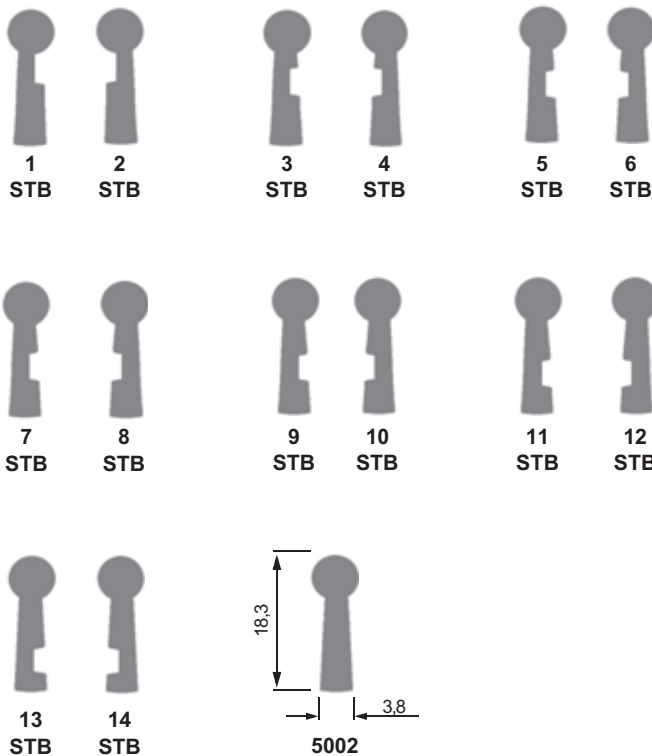
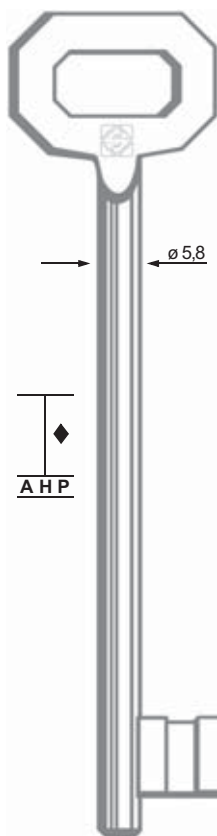

Chiavi obsolete non disponibili a stock - Obsolete keys not available from stock - Überholte Schlüssel, die nicht mehr auf Lager sind - Clés obsolètes non disponibles de stock - Llaves obsoletas no disponibles en stock - Chaves antigas não disponíveis no estoque



Obtainable with: / Ottenibili con:
Realisierbar mit: / Réalisables avec:
Obtenibles con: / Consequível com:

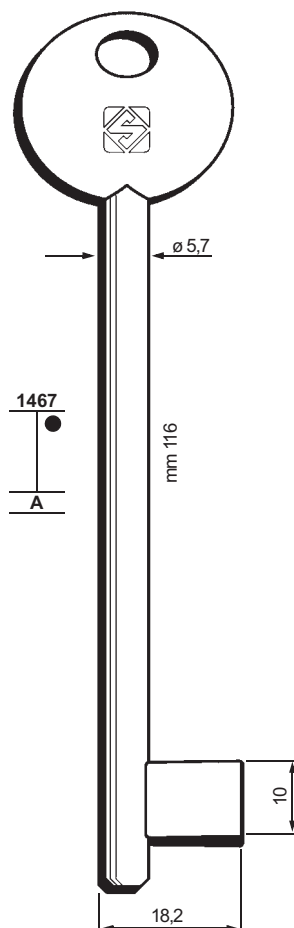

FOR:
PER:

Serrature da "Portoncino" BONAITI - "GB" (I)

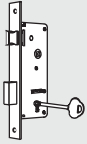

164

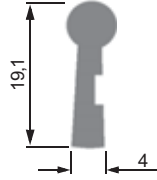
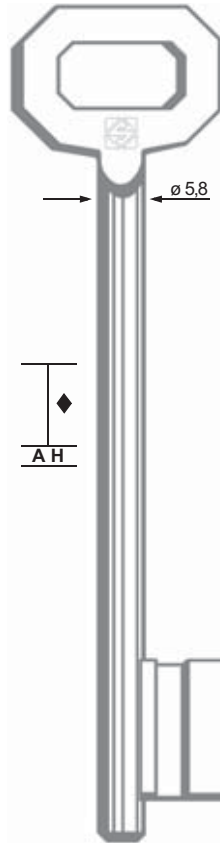

7STC Prof. → A
9STC C

17,5



Replaced by: / Sostituite da:
Ersetzt durch: / Remplacées par:
Substituidas por: / Substituído por:

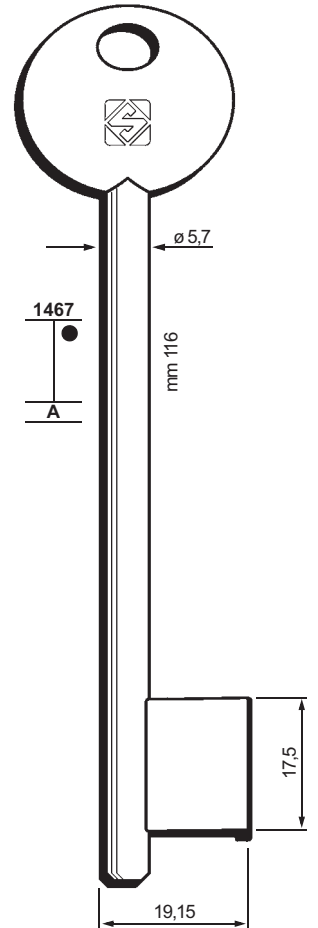

On request they are also supplied with the 14 here below illustrated cuttings; for each cutting 2 profiles.
Su richiesta vengono fornite anche con le 14 cifrature sottoriportate, per ogni cifratura 2 profili.

Nach Bedarf können wir auch mit 14 untergenannten, Chieffreierungen, 2 Profile jede Chieffrierung liefern.

Sur demande elles sont également fournies avec les 14 chiffres ci-dessous mentionnés; pour chaque chiffre 2 profils.

A pedido son provistas también con las 14 cifras debajo indicadas, por cada cifra 2 perfiles.

Obtainable with: / Ottenibili con:
Realisierbar mit: / Réalisables avec:
Obtenibles con: / Conseguível com:



Cifr.

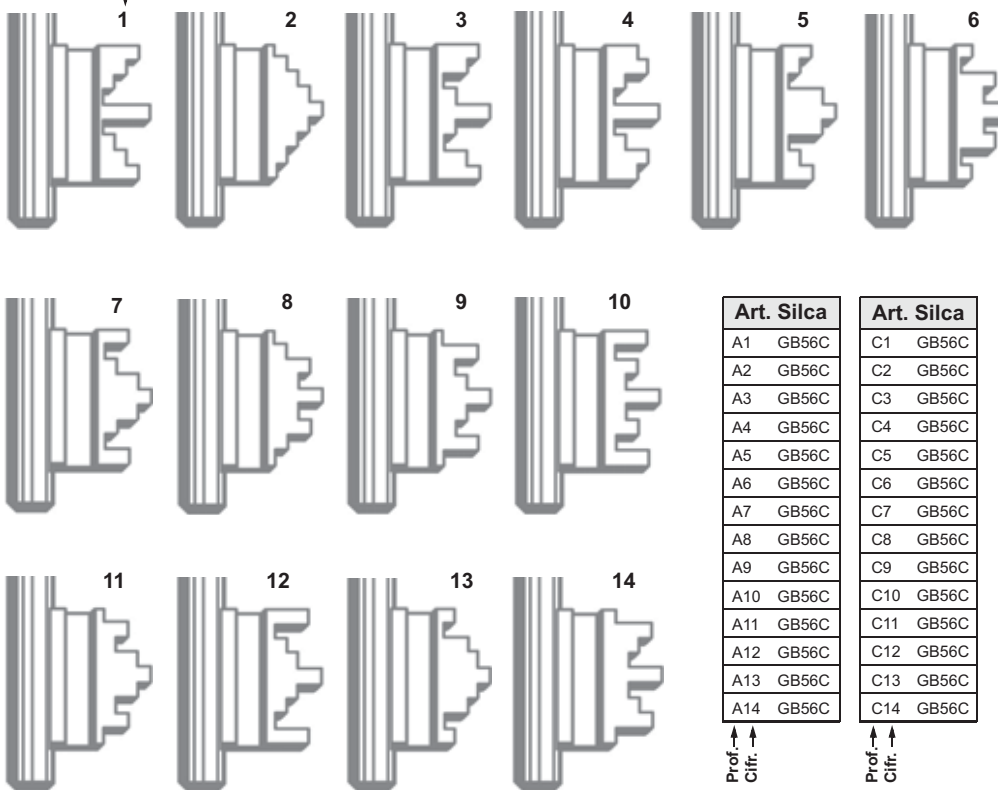

Art. Silca	Art. Silca
A1 GB56C	C1 GB56C
A2 GB56C	C2 GB56C
A3 GB56C	C3 GB56C
A4 GB56C	C4 GB56C
A5 GB56C	C5 GB56C
A6 GB56C	C6 GB56C
A7 GB56C	C7 GB56C
A8 GB56C	C8 GB56C
A9 GB56C	C9 GB56C
A10 GB56C	C10 GB56C
A11 GB56C	C11 GB56C
A12 GB56C	C12 GB56C
A13 GB56C	C13 GB56C
A14 GB56C	C14 GB56C

Prof. ↑
Cifr. ↑

Prof. ↑
Cifr. ↑



6P7D

FOR:
PER:

Serrature da "Portoncino" BONAITI - "GB" (I)



165

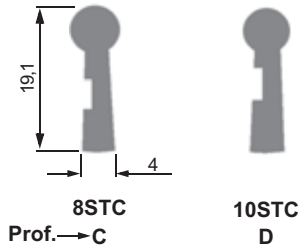
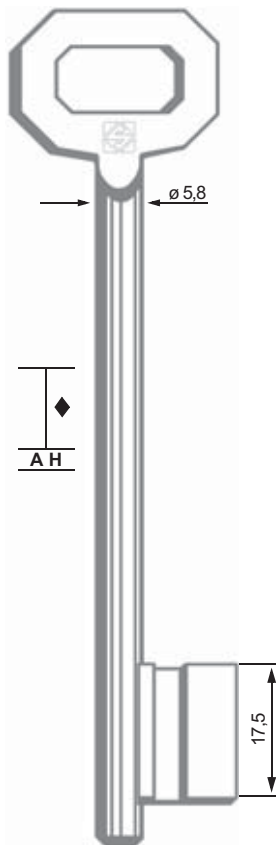

Replaced by: / Sostituite da:
Ersetzt durch: / Remplacées par:
Substituidas por: / Substituído por:



On request they are also supplied with the 14 here below illustrated cuttings; for each cutting 2 profiles.
Su richiesta vengono fornite anche con le 14 cifrature sottoriportate, per ogni cifratura 2 profili.

Nach Bedarf können wir auch mit 14 untergenannten, Chiffrierungen, 2 Profile jede Chiffrierung liefern.

Sur demande elles sont également fournies avec les 14 chiffrages ci-dessous mentionnés; pour chaque chiffrage 2 profils.

A pedido son provistas también con las 14 cifras debajo indicadas, por cada cifra 2 perfiles.

Obtainable with: / Ottenibili con:
Realisierbar mit: / Réalisables avec:
Obtenibles con: / Consequível com:

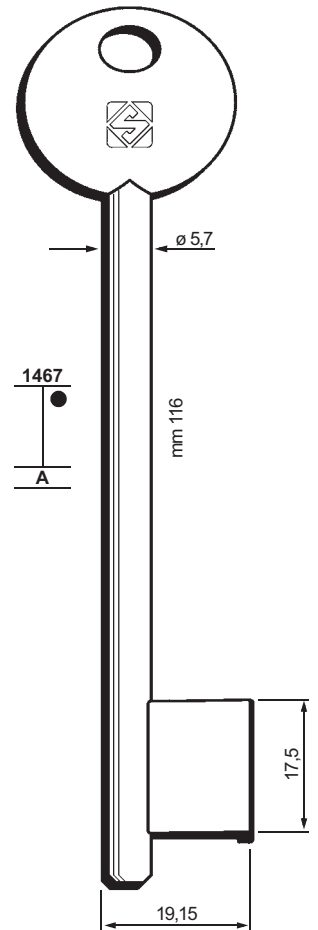

Cifr. →

Art. Silca	Art. Silca
B1 GB56C	D1 GB56C
B2 GB56C	D2 GB56C
B3 GB56C	D3 GB56C
B4 GB56C	D4 GB56C
B5 GB56C	D5 GB56C
B6 GB56C	D6 GB56C
B7 GB56C	D7 GB56C
B8 GB56C	D8 GB56C
B9 GB56C	D9 GB56C
B10 GB56C	D10 GB56C
B11 GB56C	D11 GB56C
B12 GB56C	D12 GB56C
B13 GB56C	D13 GB56C
B14 GB56C	D14 GB56C

Prof. ↑
Cifr. ↑



6P7S

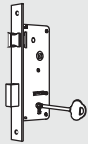

166

FOR:
PER:

PATENT Passepartout

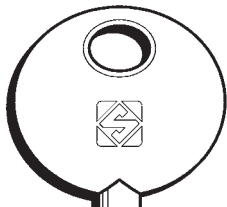

1467
AGP

For/Per			
BONAITI	MPV	PERINO	SINA
2GBG	1MPV	1PG	5IE
4GBG	3MPV	3PG	7IE
6GBG	5MPV	5PG	9IE
8GBG	7MPV	7PG	11IE
10GBG	9MPV	9PG	13IE
12GBG	11MPV	11PG	
	13MPV		
	15MPV		
	17MPV		

ø 5,6
mm 83

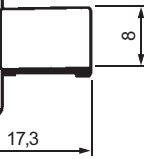

6P3D

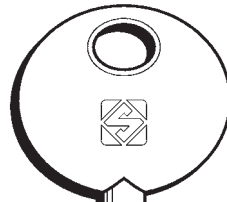

1467
AGP

For/Per			
BONAITI	MPV	PERINO	SINA
1GBG	2MPV	2PG	6IE
3GBG	4MPV	4PG	8IE
5GBG	6MPV	6PG	10IE
7GBG	8MPV	8PG	12IE
9GBG	10MPV	10PG	14IE
11GBG	12MPV	12PG	
	14MPV		
	16MPV		
	18MPV		

ø 5,6
mm 83

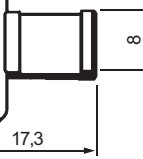

6P3S

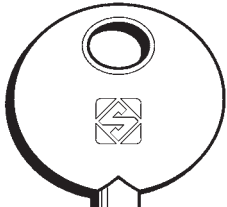

1467
AGP

For/Per				
BONAITI	MAVE	OASA	PERINO	STIQAM
2GBP	5MV	10S	1PGP	5STQ
4GBP	6MV	30S	3PGP	7STQ
6GBP	11MV	50S	5PGP	9STQ
8GBP	12MV	70S	7PGP	
10GBP		90S	9PGP	
12GBP			11PGP	

ø 5,5
mm 83

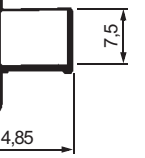

6P2D

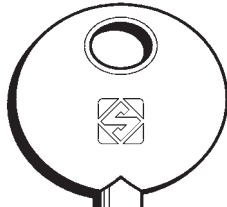

1467
AGP

For/Per				
BONAITI	MAVE	OASA	PERINO	STIQAM
1GBP	2MV	20S	2PGP	6STQ
3GBP	3MV	40S	4PGP	8STQ
5GBP	8MV	60S	6PGP	10STQ
7GBP	9MV	80S	8PGP	
9GBP		100S	10PGP	
11GBP			12PGP	

ø 5,5
mm 83

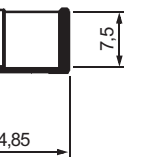

6P2S

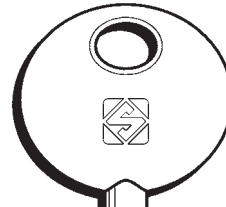

1467
AGP

ø 5,5
mm 83

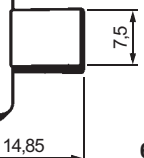

6P2MP

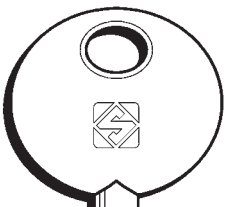

1467
AGP

For/Per		
AGB	CORNI	MP
2AGB	1MPN	1MPN
4AGB	5MPN	3MPN
6AGB	7MPN	5MPN
8AGB	9MPN	7MPN
10AGB	11MPN	9MPN
12AGB		11MPN
		13MPN
		15MPN

ø 5,8
mm 83



6P1D

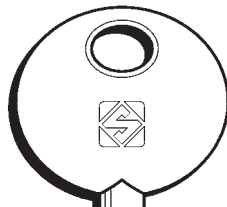

1467
AGP

ø 5,8
mm 83



6P1S

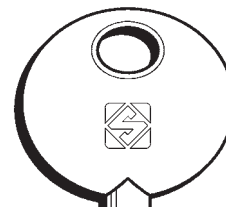

1467
AGP

ø 5,8
mm 83

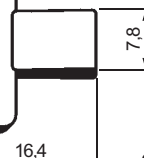

6P1MP

FOR:
PER:

PATENT Passepartout

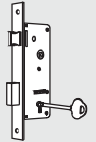

167

CORNI

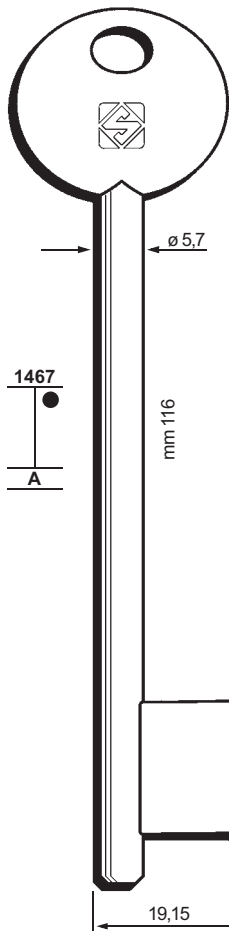

For/Per
CORNI
1STC
3STC
5STC
7STC
9STC
11STC

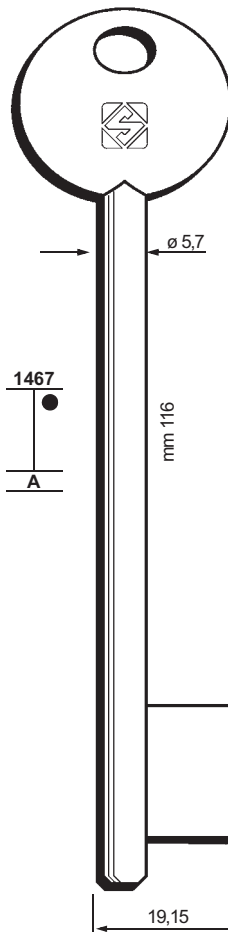

For/Per
CORNI
2STC
4STC
6STC
8STC
10STC
12STC

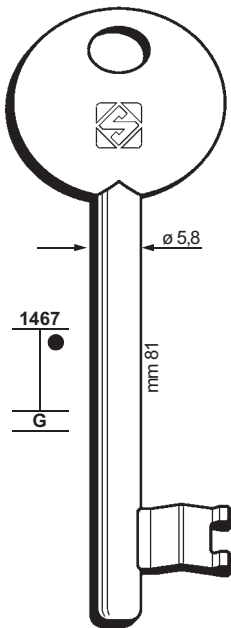

For/Per
CORNI
2CCN
2CCG
2CC
20CC



For/Per
CORNI
1CCN
1CCG
1CC
19CC



For/Per	
CORNI	
3CCN	3CC
9CCN	9CC
3CCG	21CC
9CCG	27CC



For/Per	
CORNI	
4CCN	4CC
10CCN	10CC
4CCG	22CC
10CCG	28CC



For/Per	
CORNI	
6CCN	6CC
7CCN	7CC
6CCG	24CC
7CCG	25CC



For/Per	
CORNI	
5CCN	5CC
8CCN	8CC
5CCG	23CC
8CCG	26CC



For/Per	
CORNI	
11CCN	11CC
13CCN	13CC
15CCN	15CC
11CCG	29CC
13CCG	31CC
15CCG	33CC



For/Per	
CORNI	
12CCN	12CC
14CCN	14CC
16CCN	16CC
12CCG	30CC
14CCG	32CC
16CCG	34CC



For/Per
CORNI
17CCN
17CCG
17CC
35CC



For/Per
CORNI
18CCN
18CCG
18CC
36CC

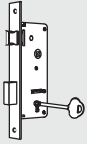

168

FOR:
PER:

PATENT

EUREKA

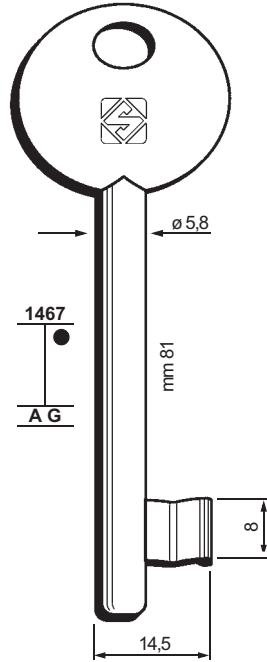

FOR:
PER:

PATENT "mappa piena"

MP CORNI

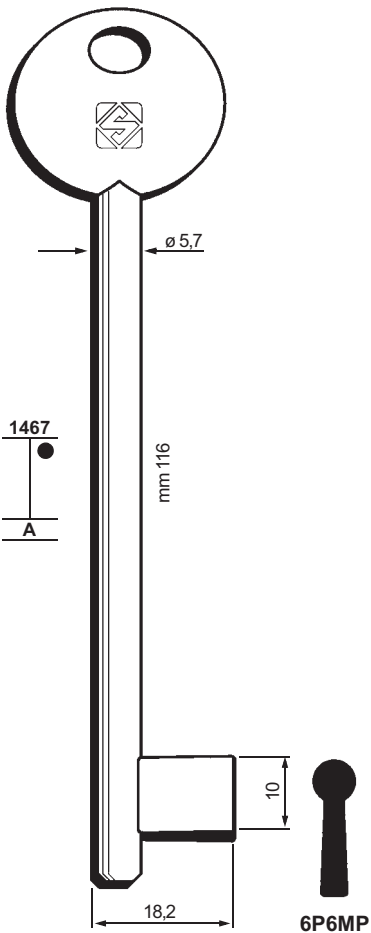

BONAITI

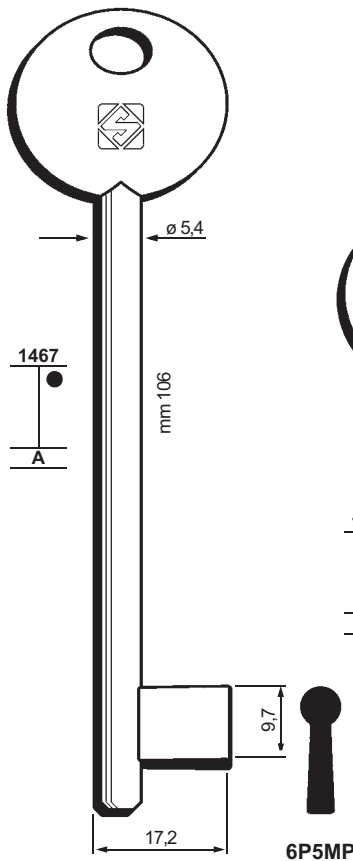

MP

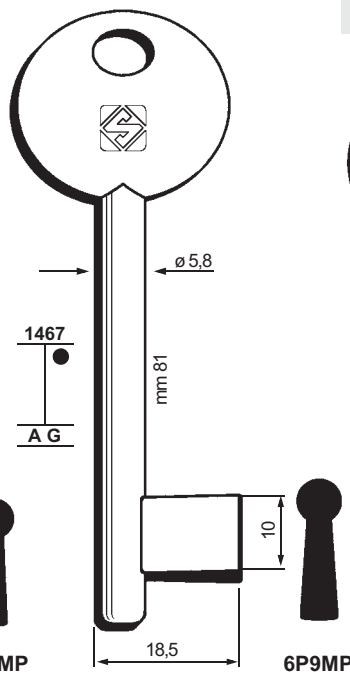

MG (MONTI)

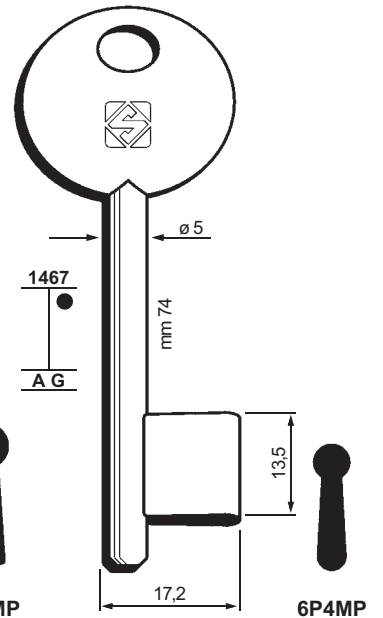



Ornamental keys
Chiavi in stile per mobili
Mobelschlüssel im Stil
Clés traditionnelles pour meubles
Llaves en estilo antiguo para muebles
Chaves para móveis de estilo

FOR:
PER:

MASCHI e FEMMINE per MOBILI

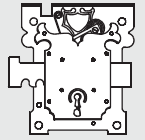

171

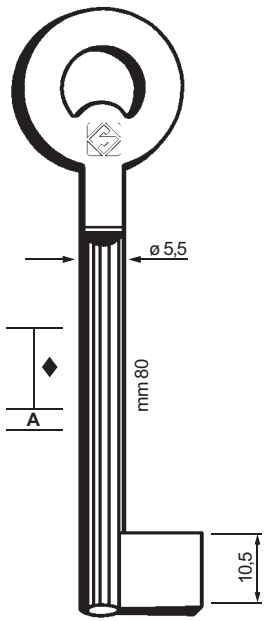

6803

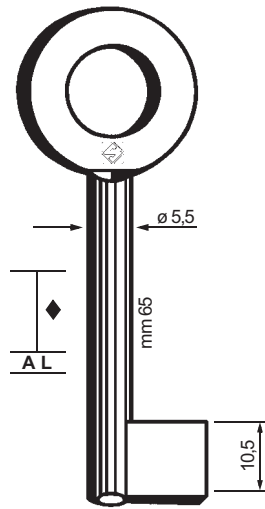

6802

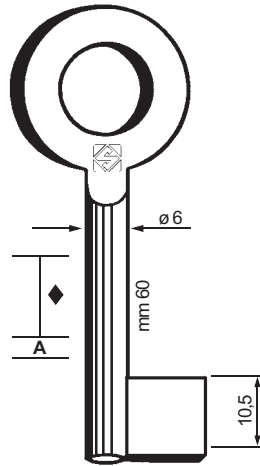

6806

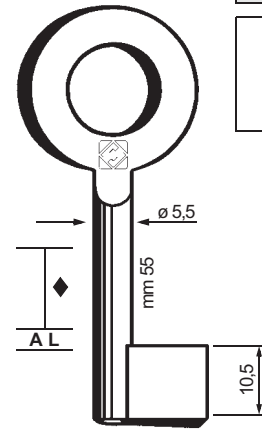

6805

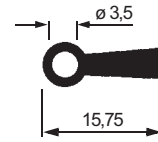
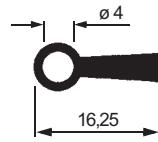
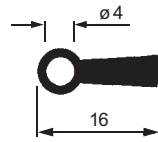
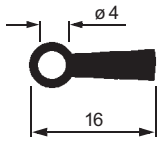

FOR:
PER:

MASCHI e FEMMINE per MOBILI

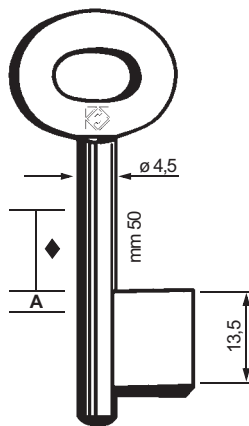

5704

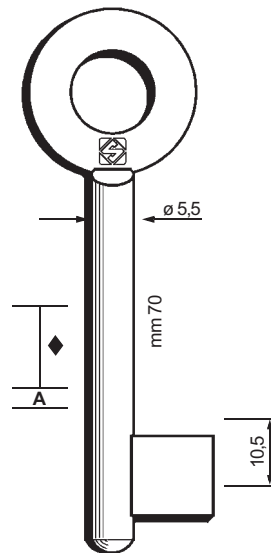

5703

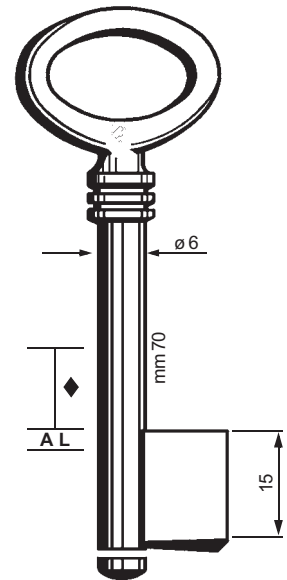

5507

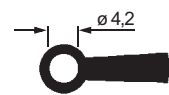
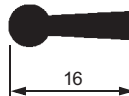
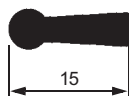

6507

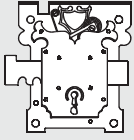

172

FOR:
PER:

FEMMINE per MOBILI

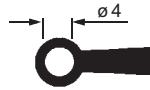
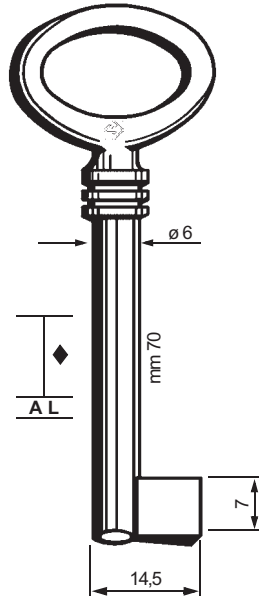

6507/1

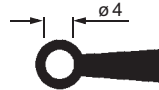
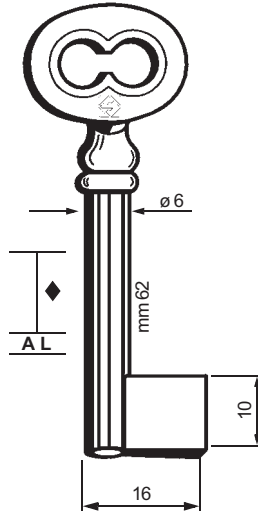

6506

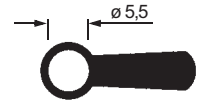
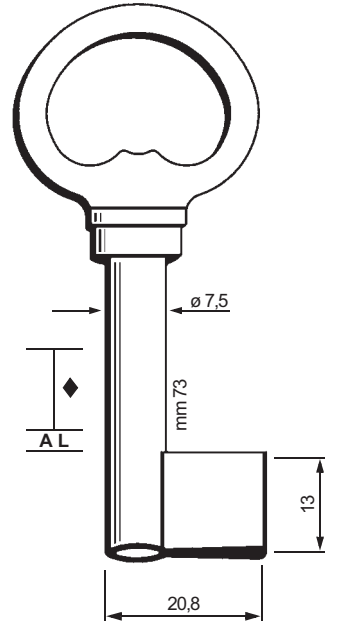

6507/3

FOR: FEMMINE per MOBILI

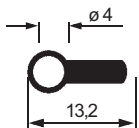
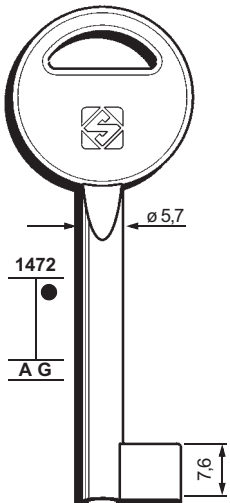

3FB00

FOR: FEMMINE per MOBILI

"EURO"

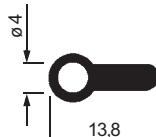
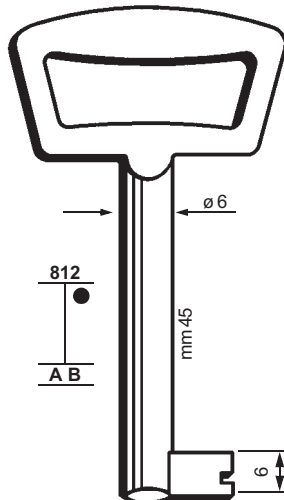

3FEU00

FOR: FEMMINE per MOBILI

"GEGE"

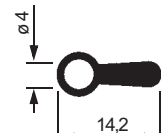
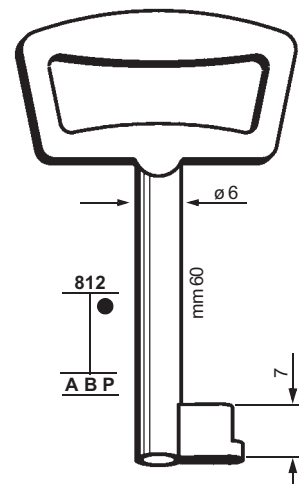

3FGE00

FOR:
PER:

FEMMINE per MOBILI "GEGE"

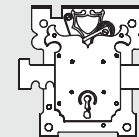



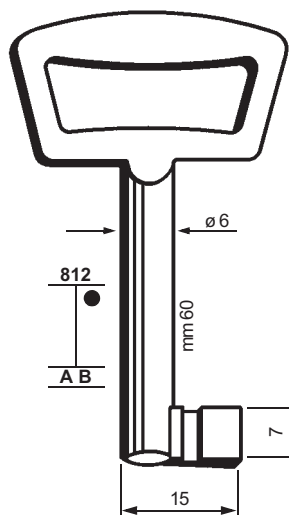

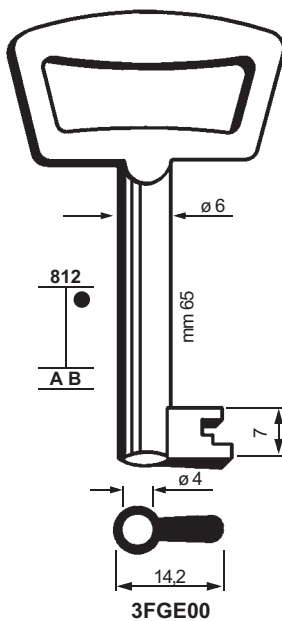

173



-  **3FGE10**
1
-  **3FGE20**
2
-  **3FGE30**
3
-  **3FGE40**
4



- | | |
|---|--|
|  3FGE01
1 |  3FGE04
4 |
|  3FGE02
2 |  3FGE05
5 |
|  3FGE03
3 |  3FGE06
6 |

FOR:
PER:

FEMMINE per MOBILI "MOBELLA"

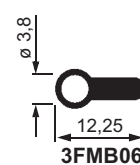
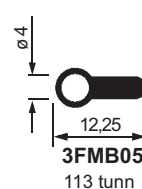
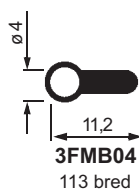
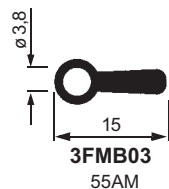
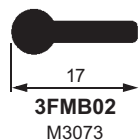
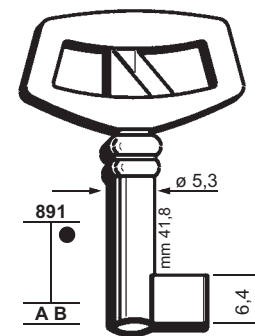
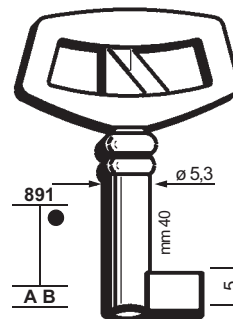
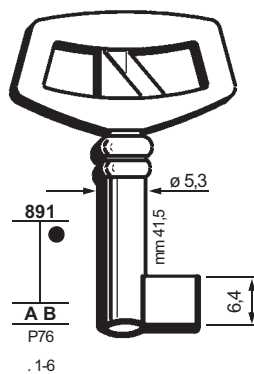
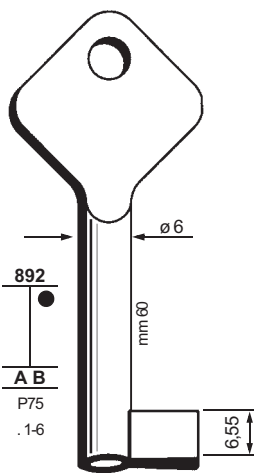
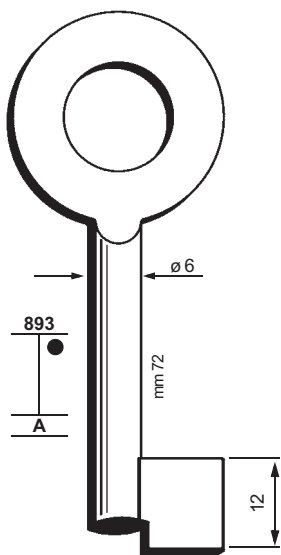

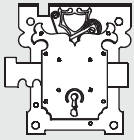

174

FOR:
PER:

FEMMINE per MOBILI "MOBELLA"

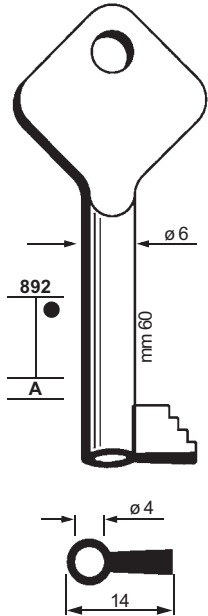

3FMB03-1
55AM-1



3FMB03-2
55AM-2



3FMB03-3
55AM-3



3FMB03-4
55AM-4



3FMB03-5
55AM-5



3FMB03-6
55AM-6

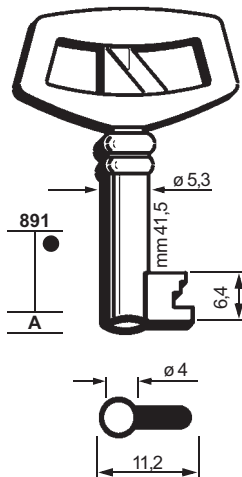

3FMB04-1
113 breed-1



3FMB04-2
113 breed-2



3FMB04-3
113 breed-3



3FMB04-4
113 breed-4



3FMB04-5
113 breed-5



3FMB04-6
113 breed-6

FOR:
PER:

FEMMINE per MOBILI "REFORM"

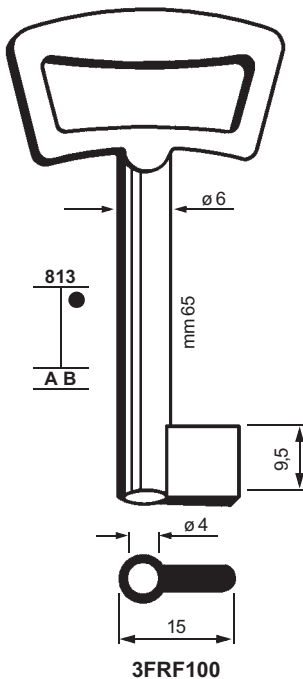

3FRF100

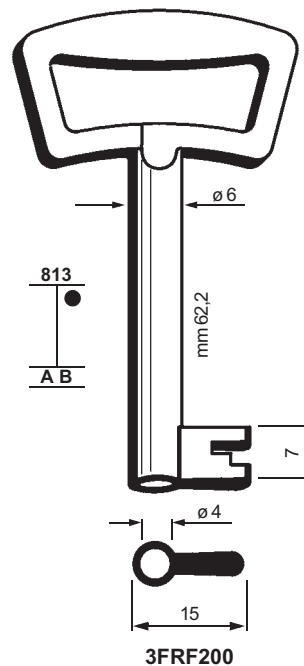

3FRF200

FOR:
PER:

FEMMINE per MOBILI "REFORM"

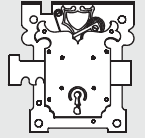

175

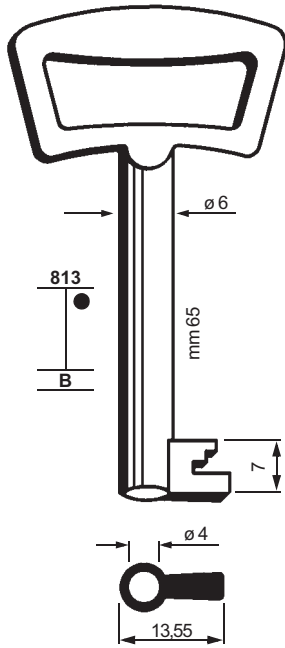

3FRF01
1



3FRF04
2



3FRF02
3



3FRF05
4



3FRF03
5



3FRF06
6

FOR:
PER:

FEMMINE per MOBILI in STILE ADATTABILI

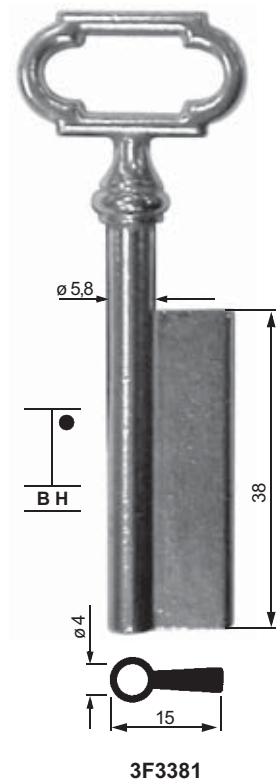
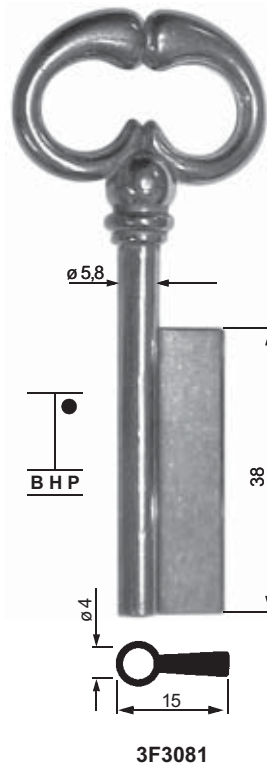
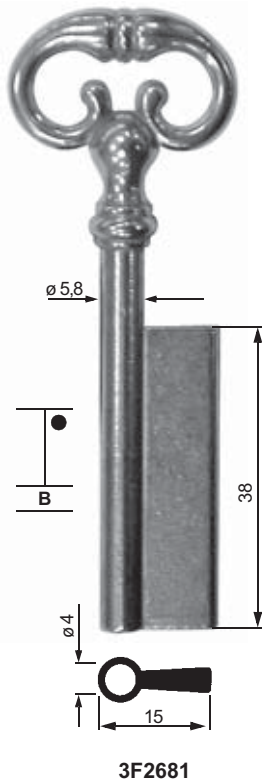

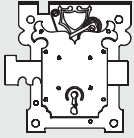

FOR:

PER:

FEMMINE per MOBILI in STILE

ADATTABILI

176

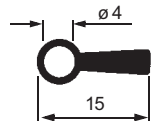
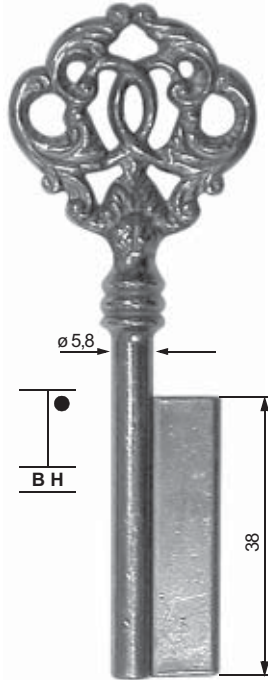

3F6081

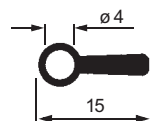
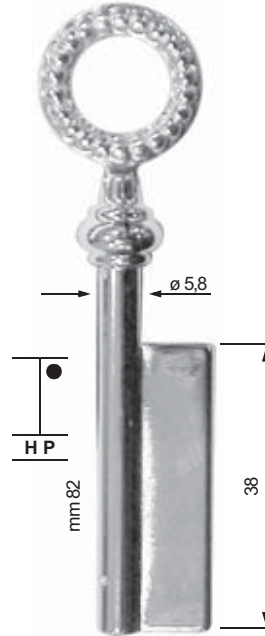

3F4781

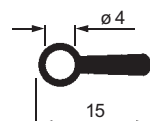
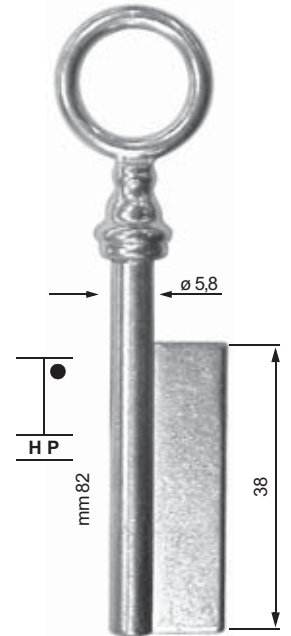

3F4881

FOR:
PER:

FEMMINE per MOBILI in STILE

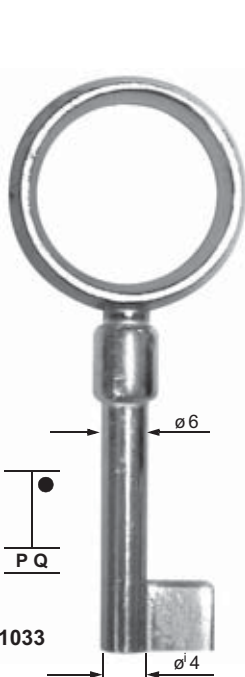

3F1033

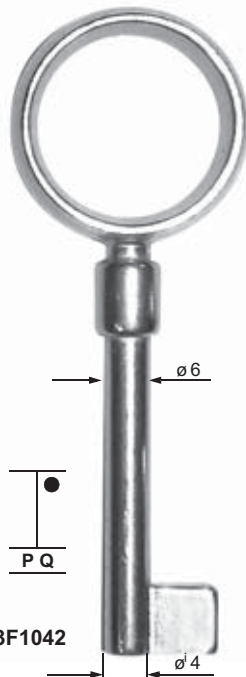

3F1042

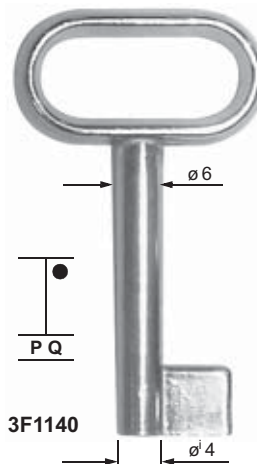

3F1140

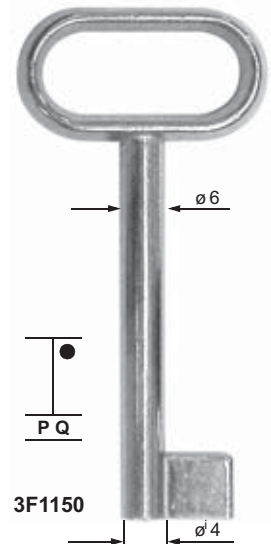

3F1150

FOR:
PER:

FEMMINE per MOBILI in STILE

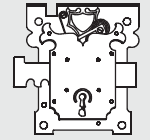

177

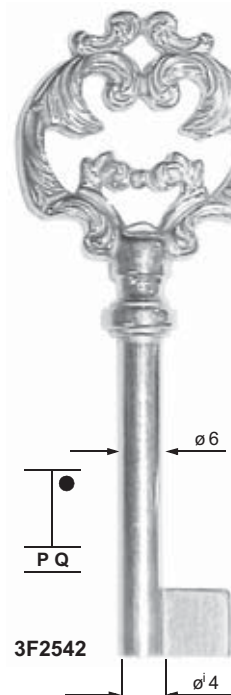
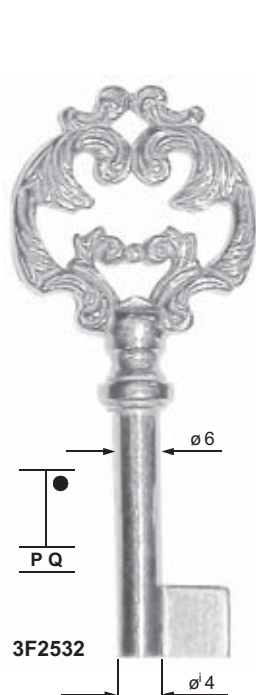
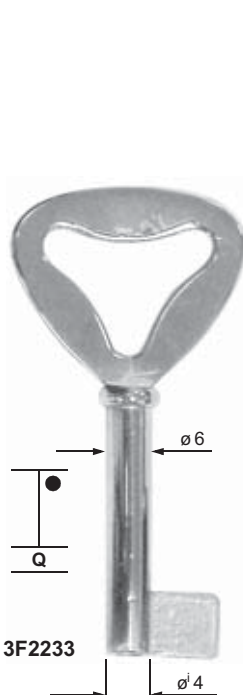
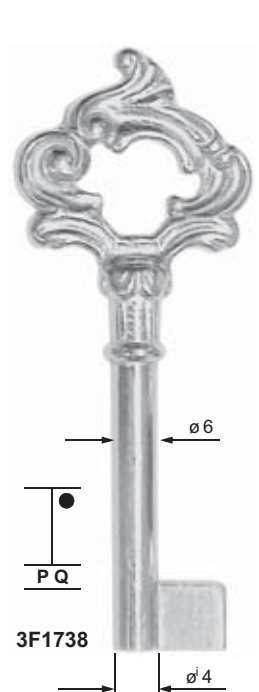
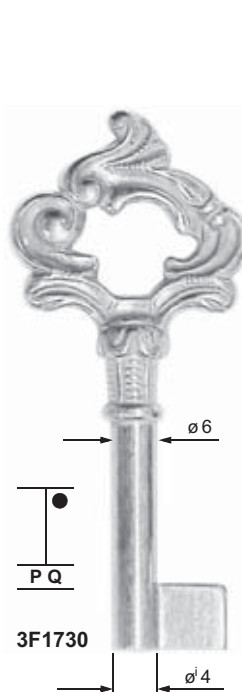
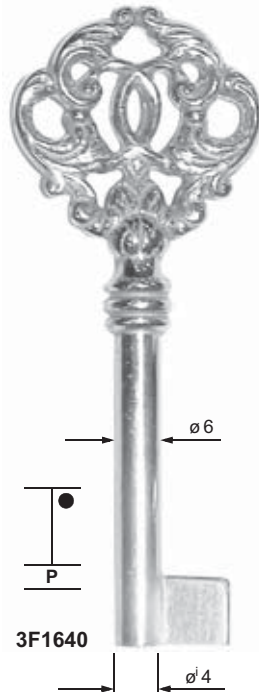
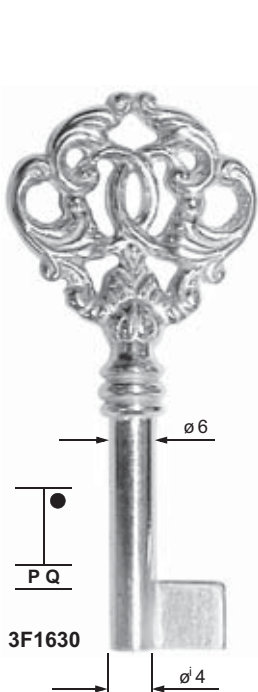
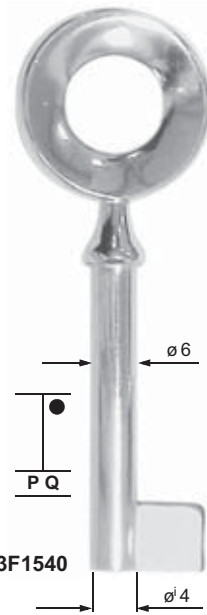
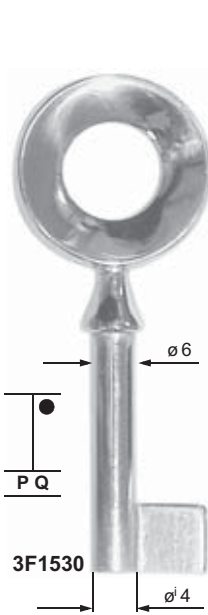
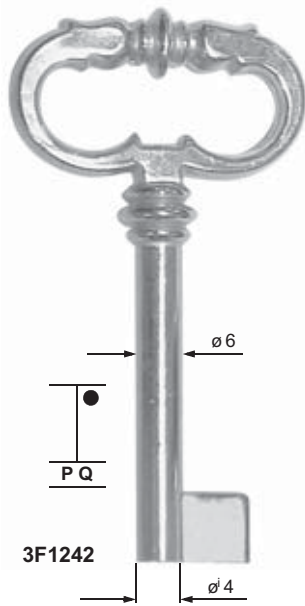
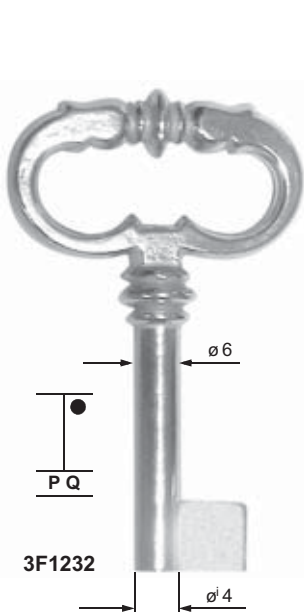

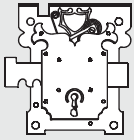

FOR:
PER:

FEMMINE per MOBILI in STILE

178

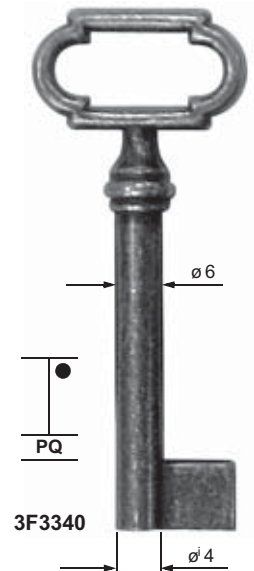
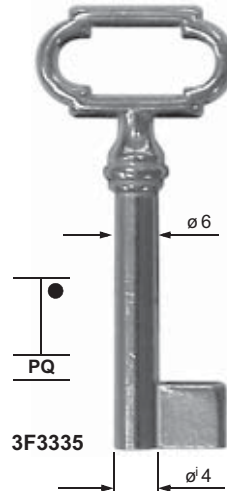
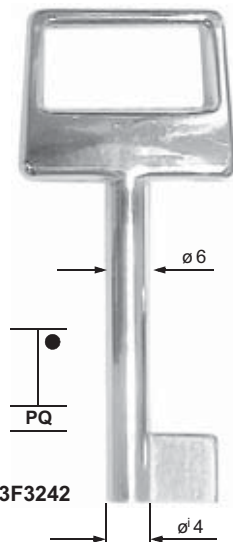
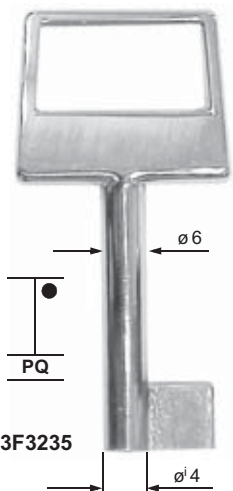
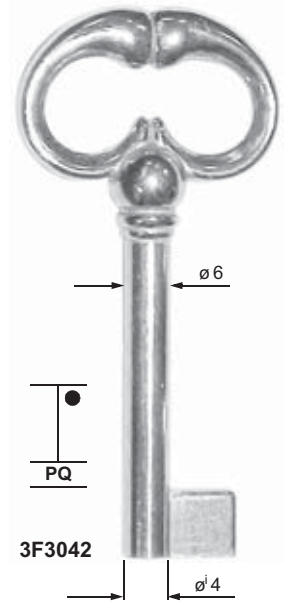
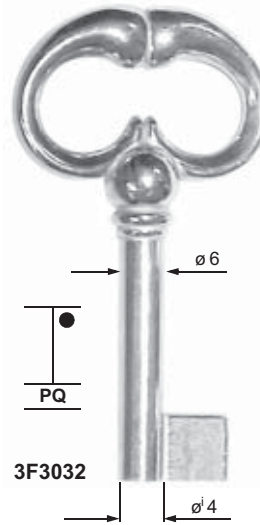
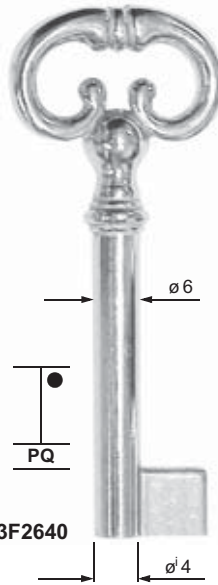
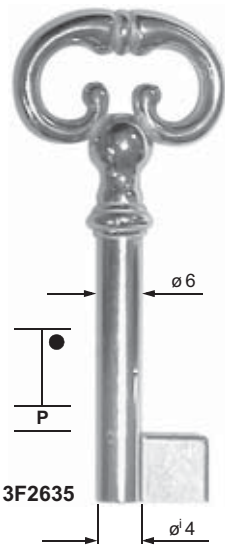
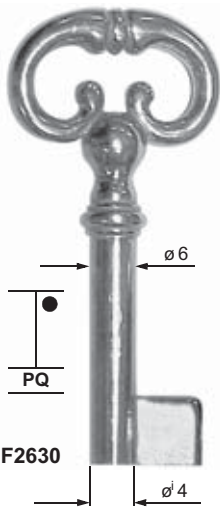
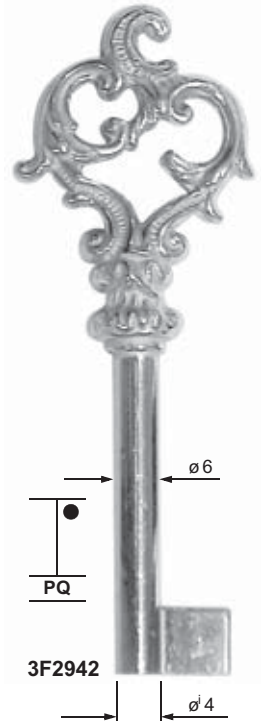
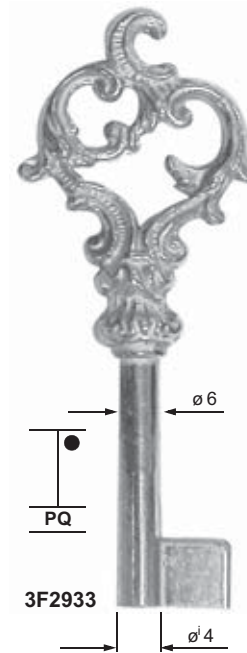
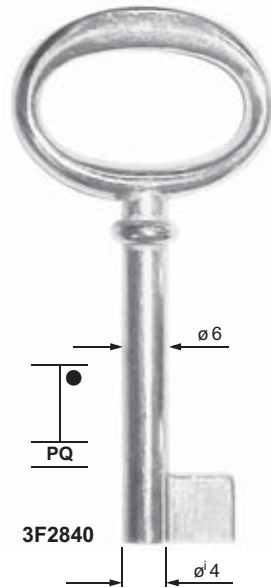
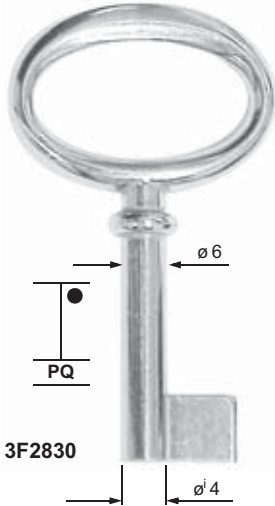

FOR:
PER:

FEMMINE per MOBILI in STILE

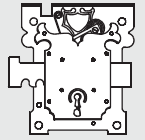

179

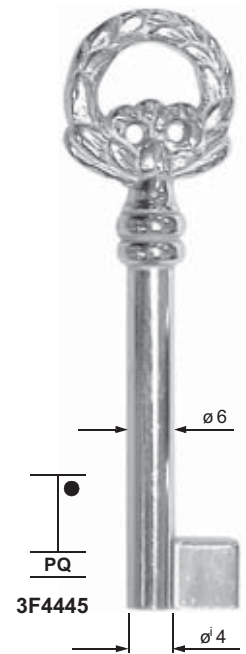
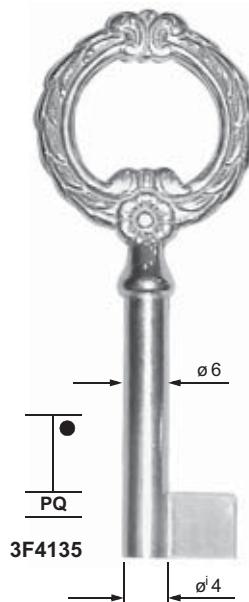
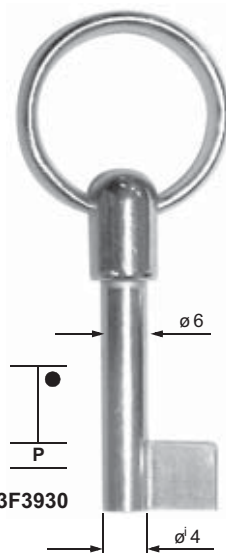
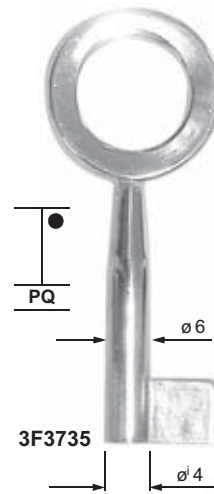

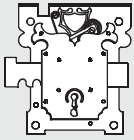

180

FOR:
PER:

FEMMINE per MOBILI in STILE

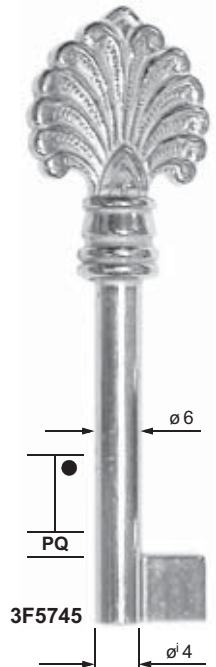
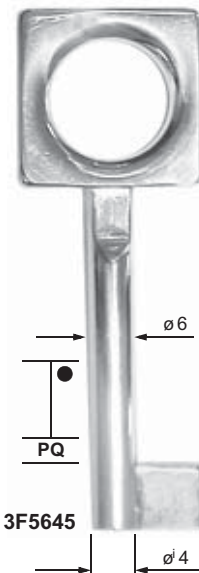
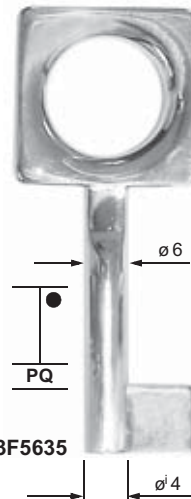
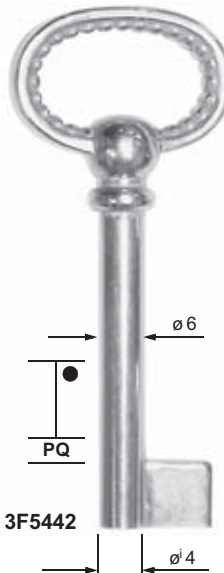
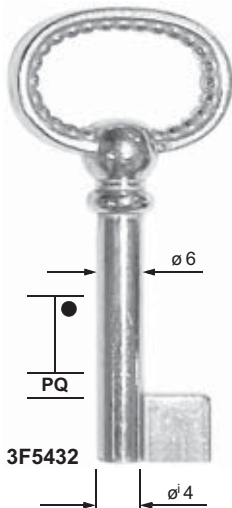
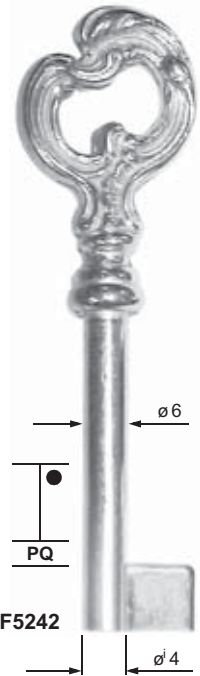
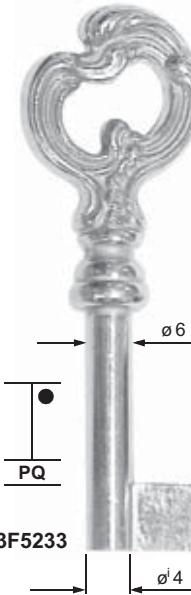
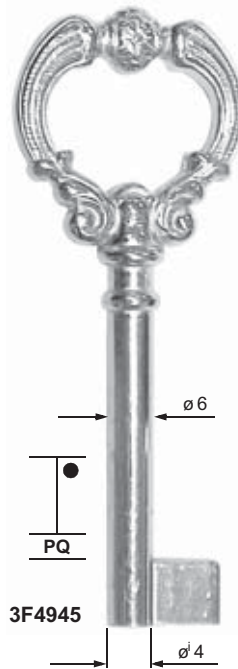
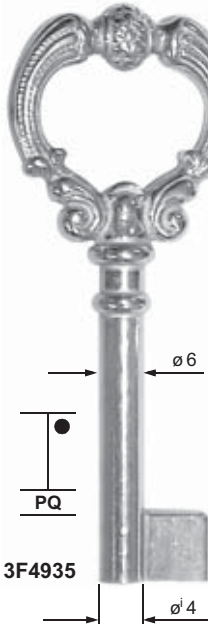
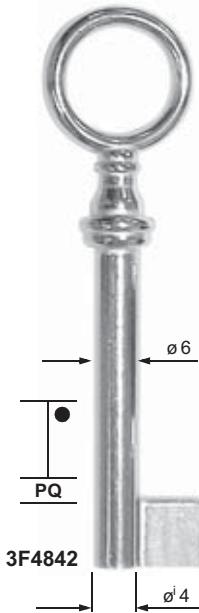
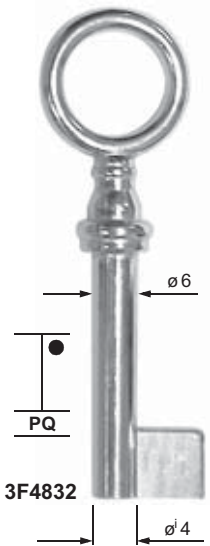
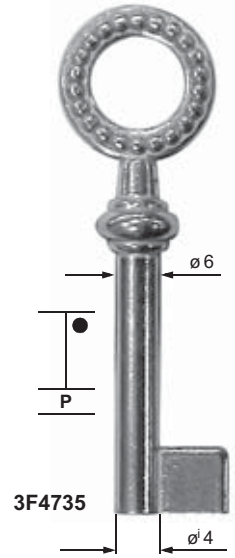
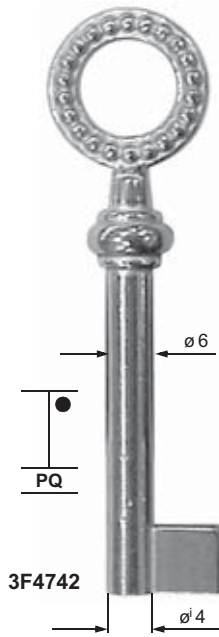
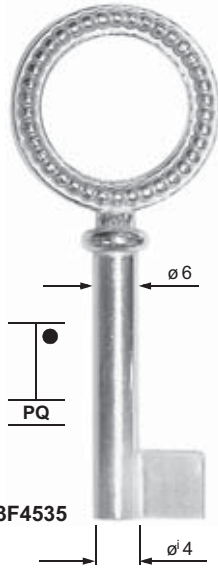
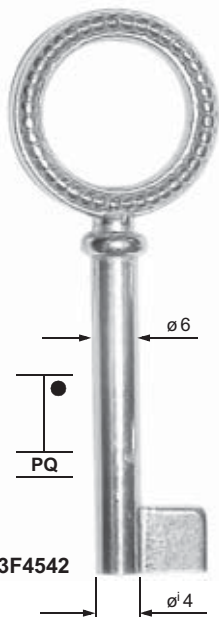

FOR:
PER:

FEMMINE per MOBILI in STILE

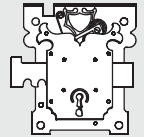

181

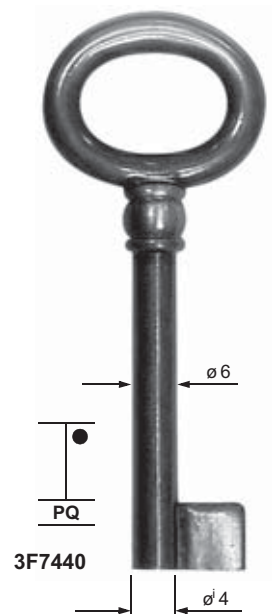
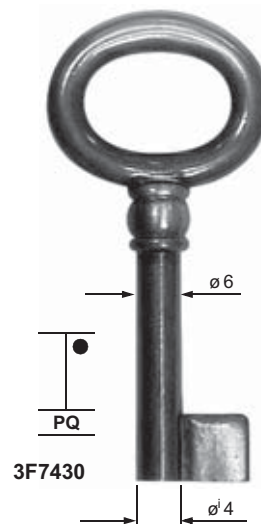
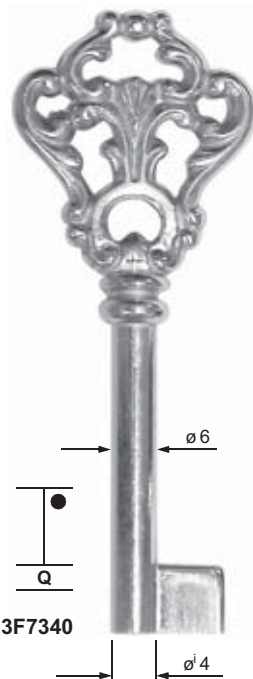
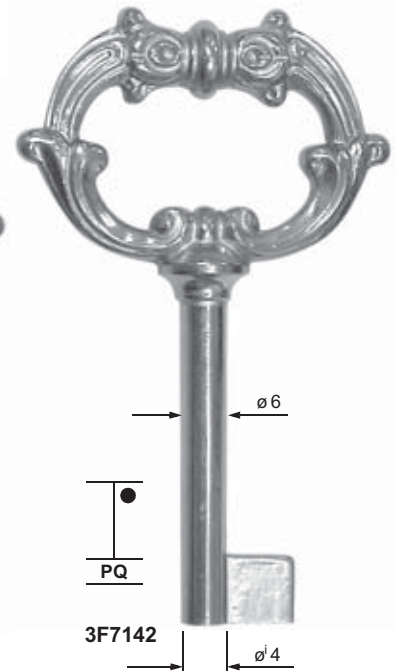
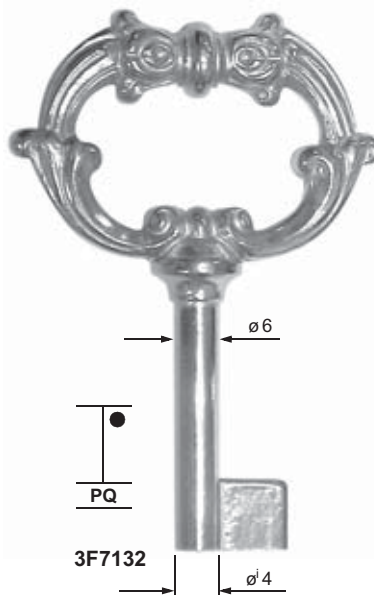
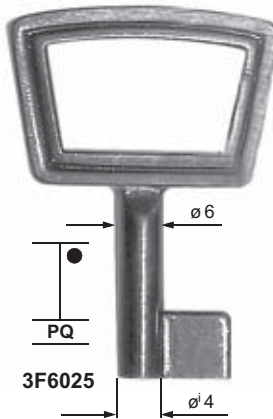
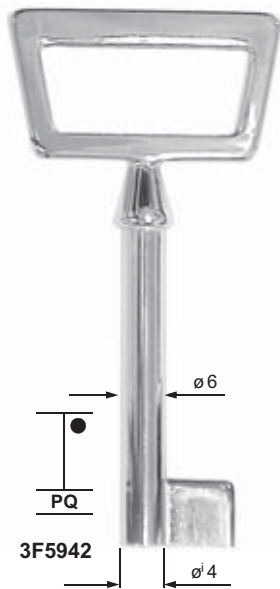

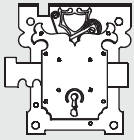

FOR: **FEMMINE SNODATE per MOBILI in STILE**
PER:

182

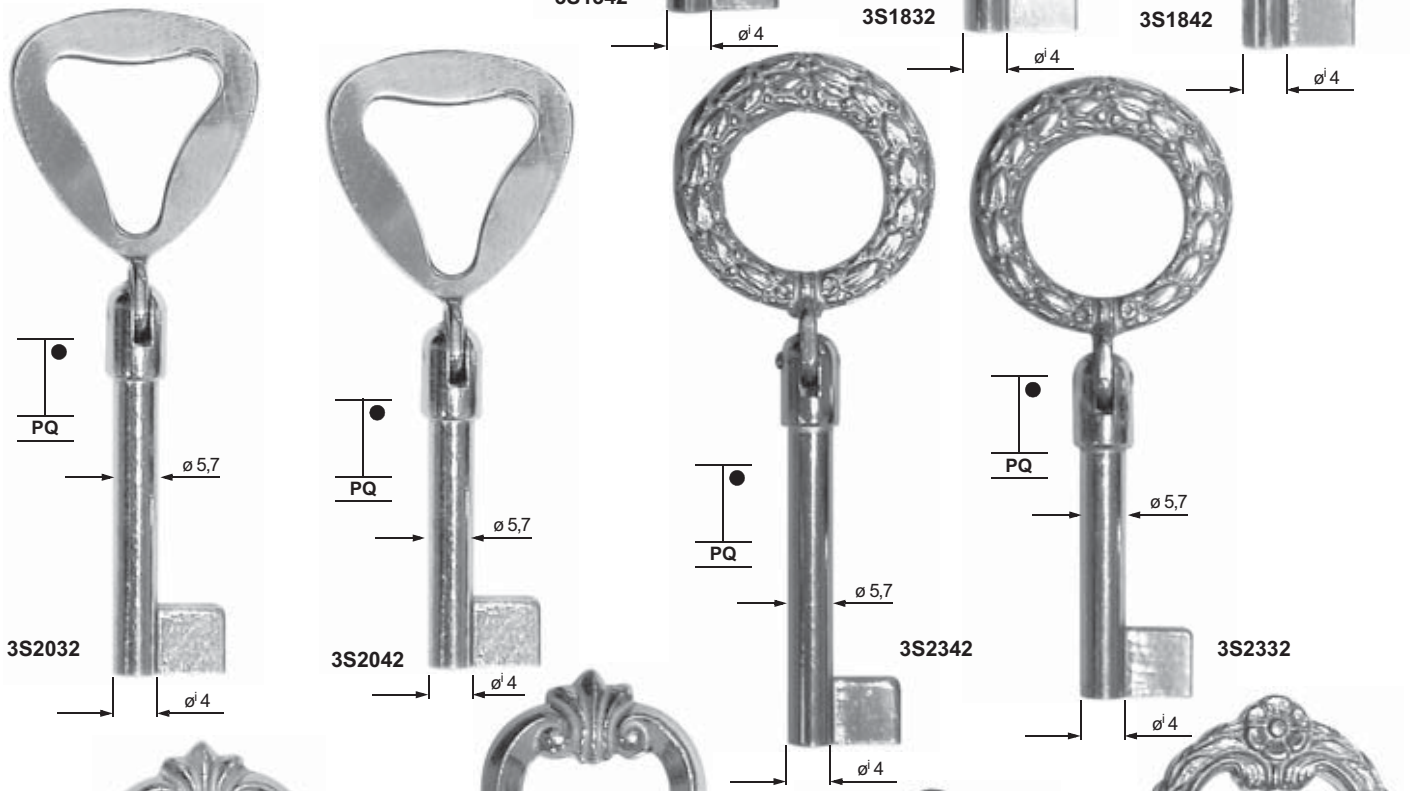
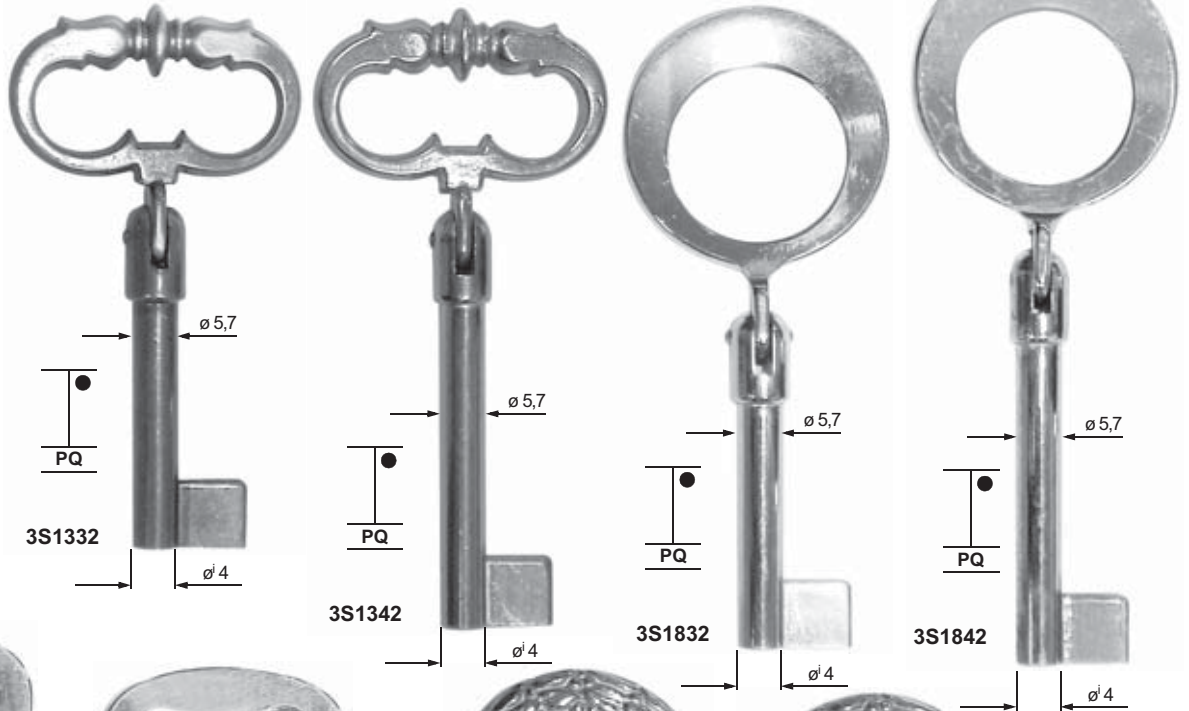

FOR:
PER:

FEMMINE SNODATE per MOBILI in STILE

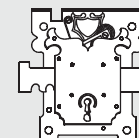

183

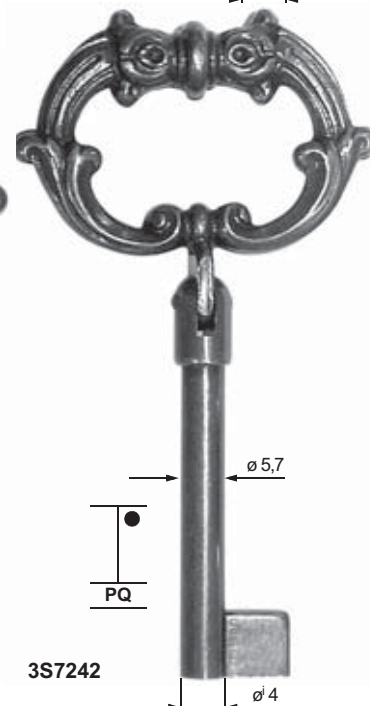
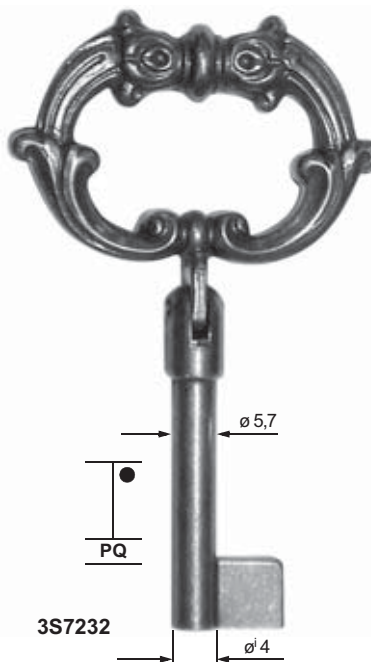
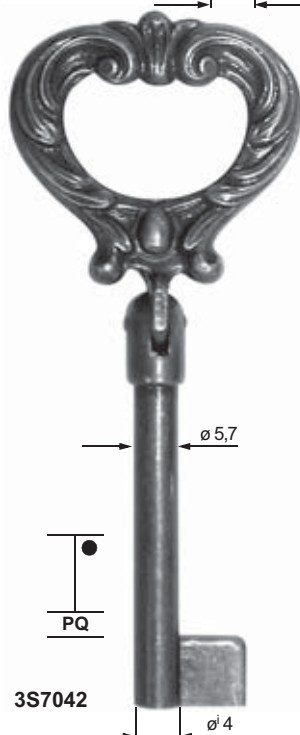
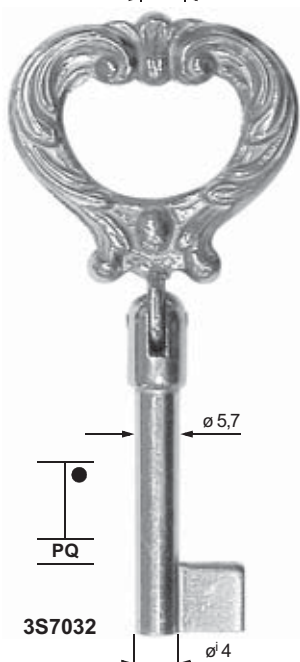
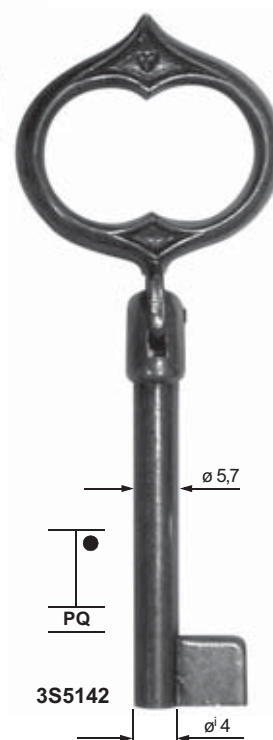
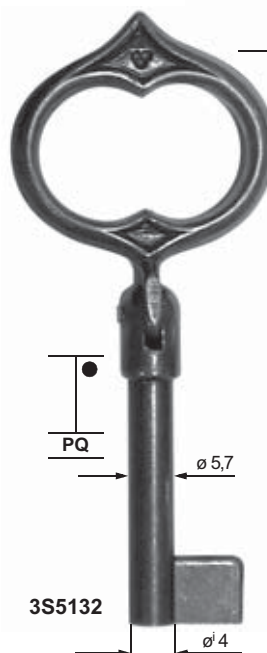
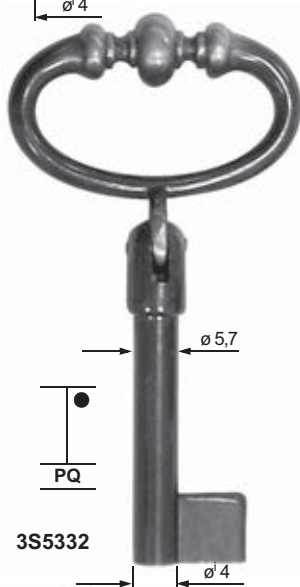
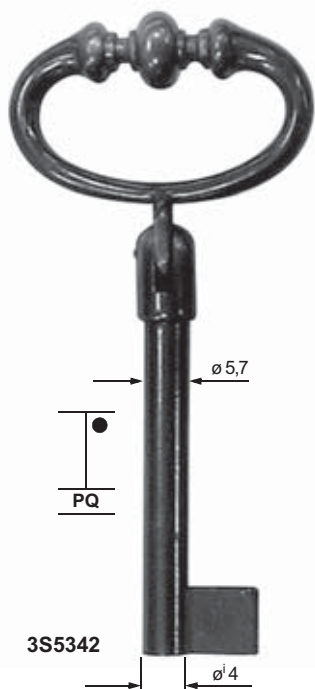
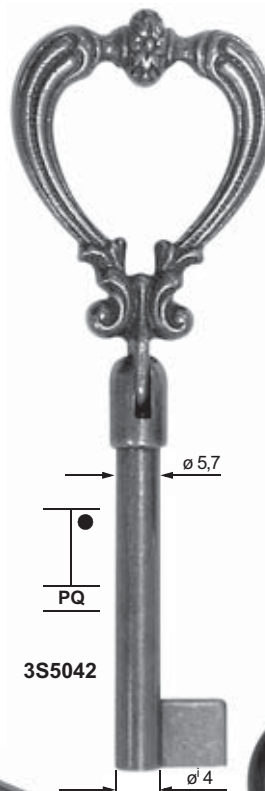
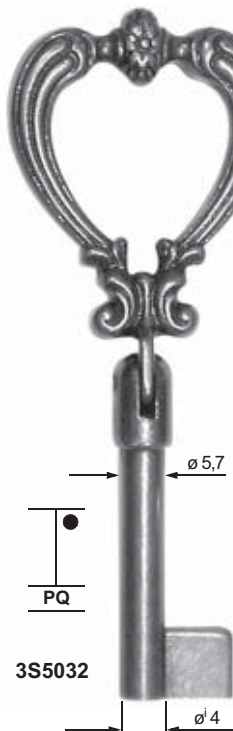
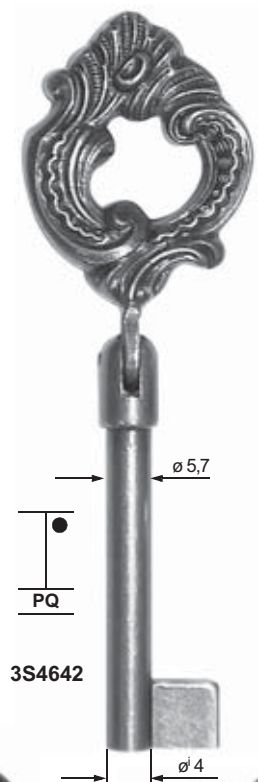
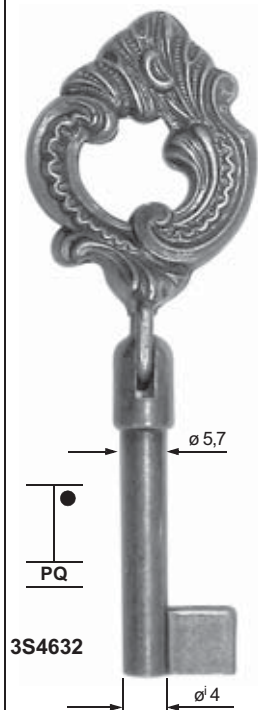

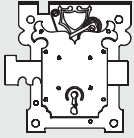

FOR:
PER:

FEMMINE MIGNON per MOBILI in STILE

184

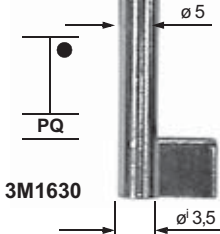

3M1630

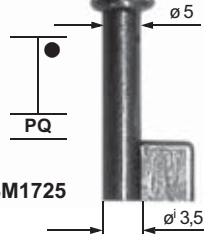

3M1725

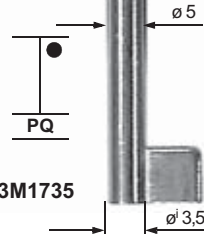

3M1735

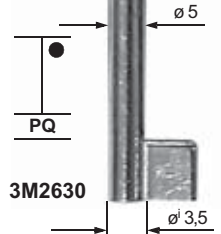

3M2630

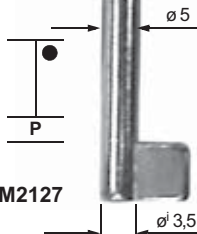
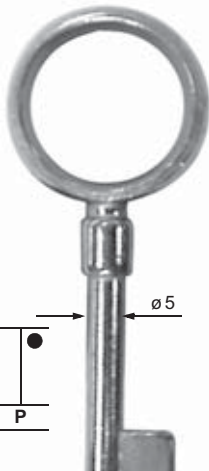

3M2127

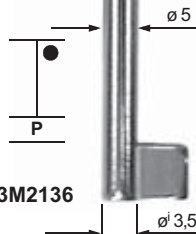

3M2136

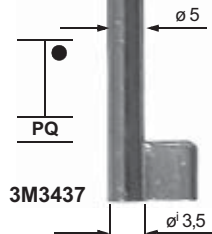
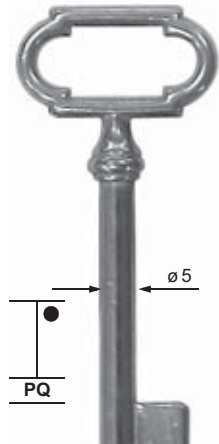

3M3437

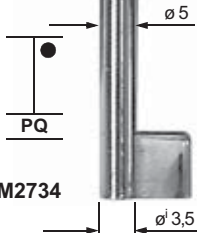

3M2734

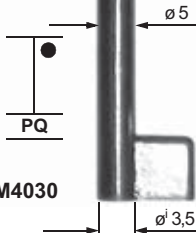
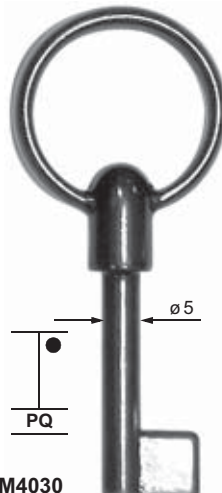

3M4030

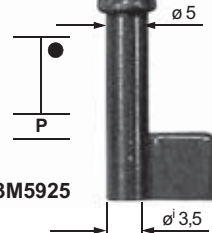
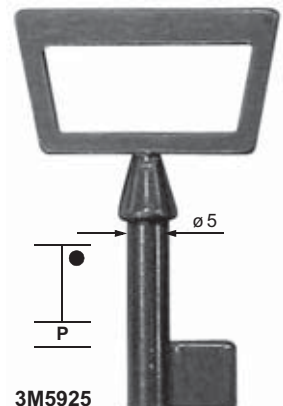

3M5925

FOR:
PER:

TESTE DI CHIAVI

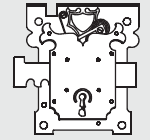

185

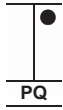

3T16

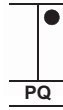

3T17



3T26

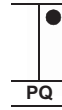

3T29

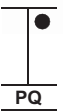

3T30



3T33



3T43



3T44



3T47



3T48



3T52



3T54



3T57

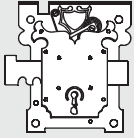

FOR:
PER:

per SERRATURE PATENT

186

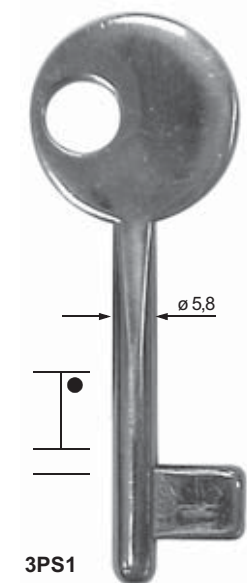
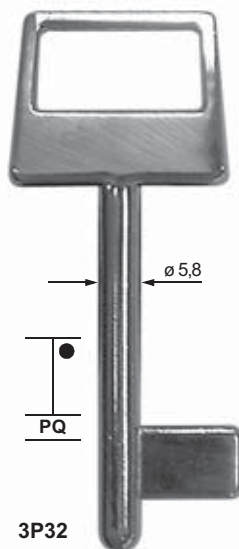
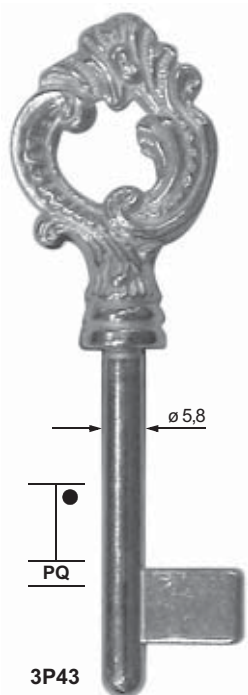
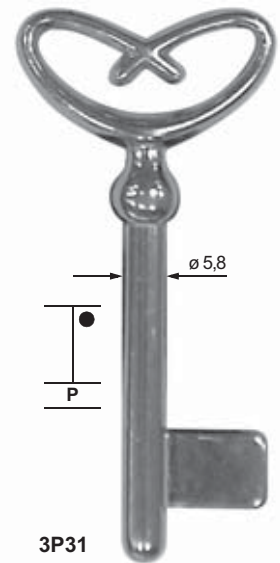
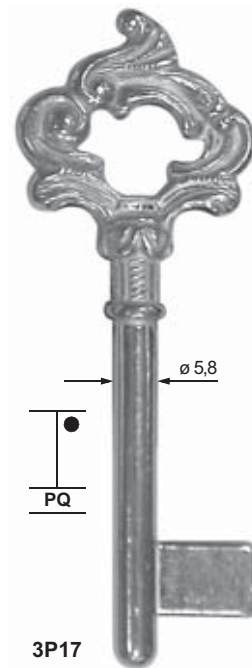
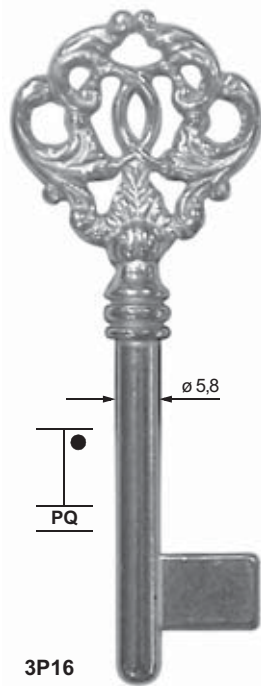



Welded keys
Chiavi saldate
Geschweisste Schlüssel
Clés soudees
Llaves soldadas
Chaves soldadas

FOR:
PER:

ASSA

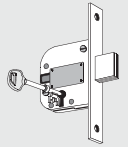

189

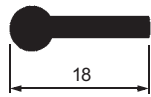
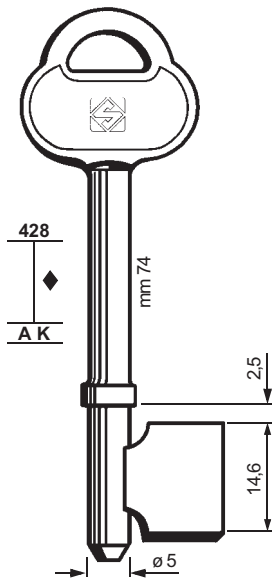

2AS1
2741

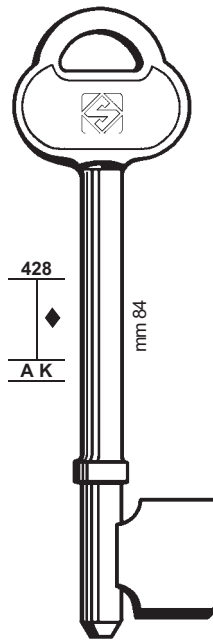

2AS2
2741

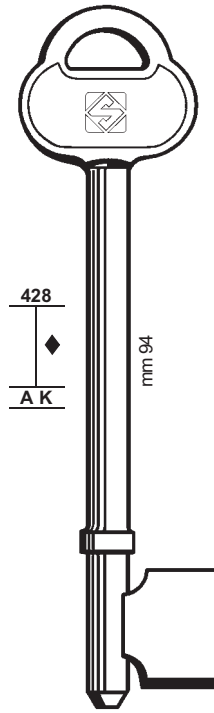

2AS3
2741

FOR:
PER:

ASSA

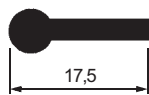
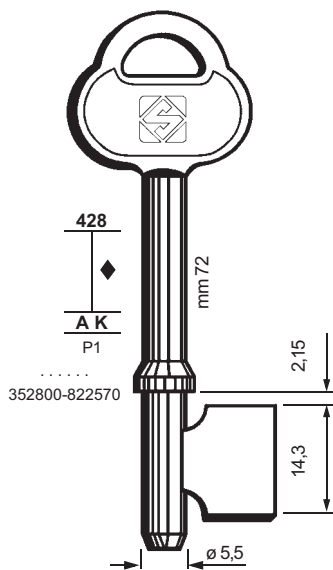

2AS4
90000

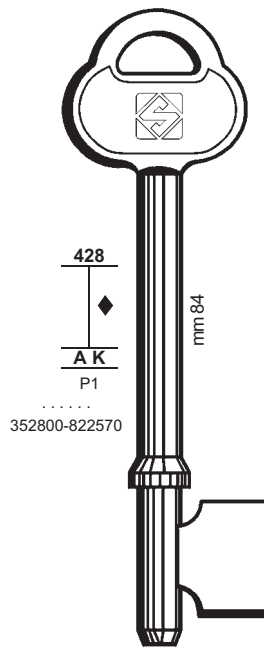

2AS5
90000

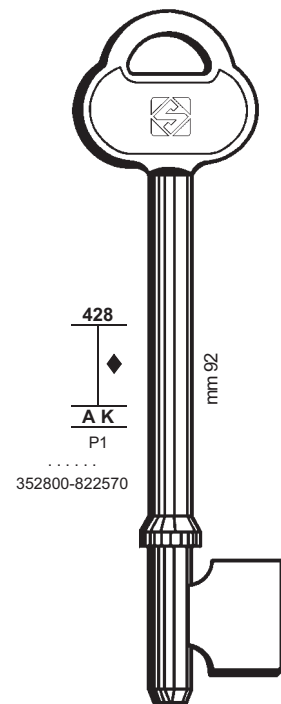

2AS6
90000

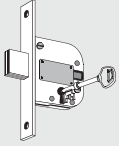

190

FOR:

PER:

ASSA

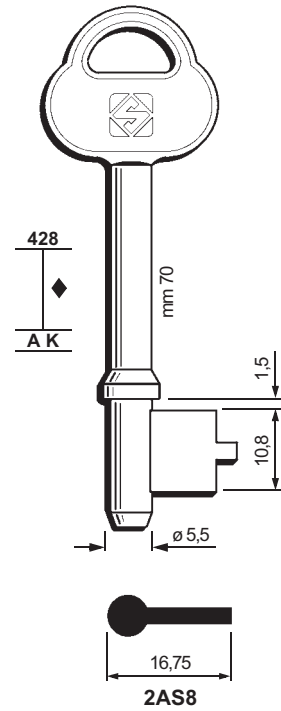
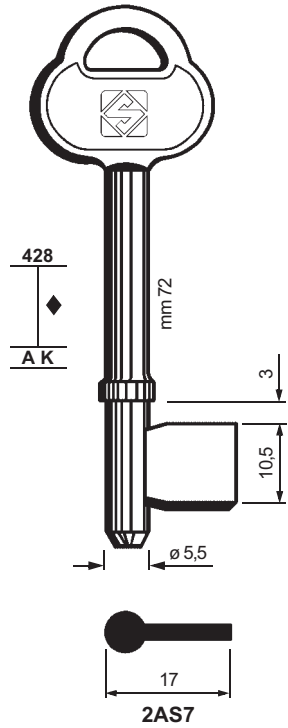

FOR:

PER:

ASSA

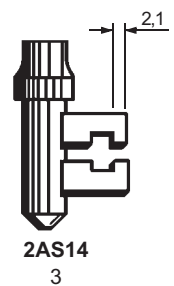
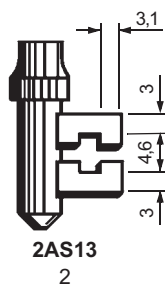
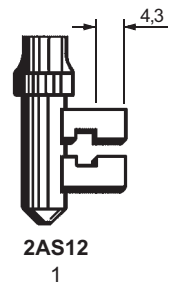
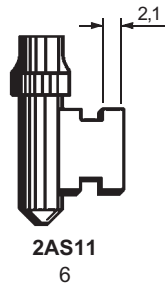
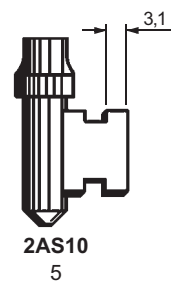
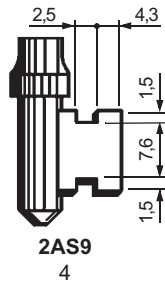
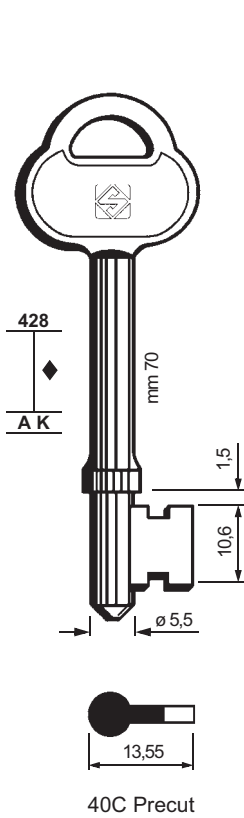

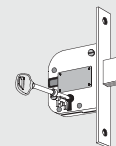

191

2AS16-...

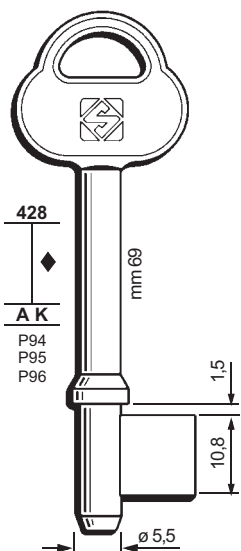

2AS16
40C Precut

- ... 1/2 131-332
- ... 1/2/3 133-333
- ... 1/2/3 311-322

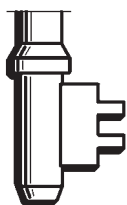

131



132

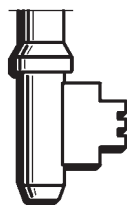

133

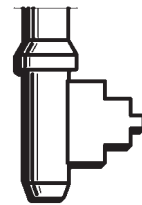

134



231



233



234

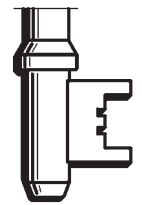

311



312



313



314



323

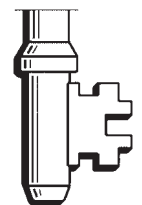

2311



2312



2321

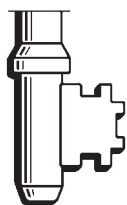

2322



2331



2341

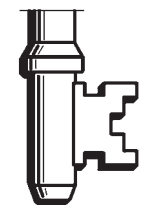

3211



3212



3231



3232



3311



3321

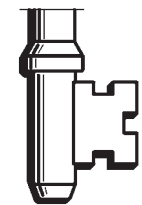

3322



3331

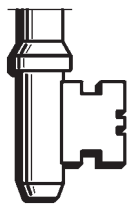

3332

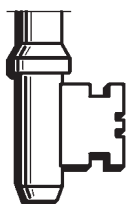

3333

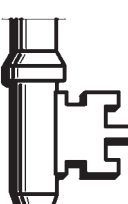

3241

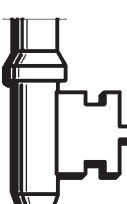

3343

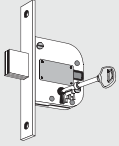

192

FOR:

PER:

ASSA

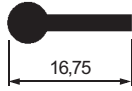
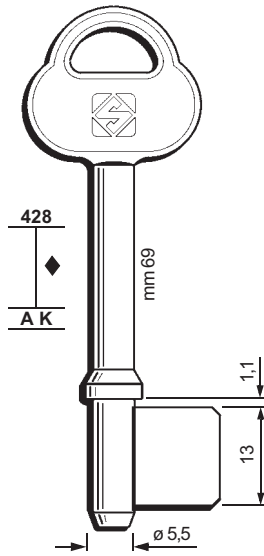

2AS18
40D Blank

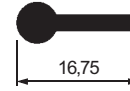
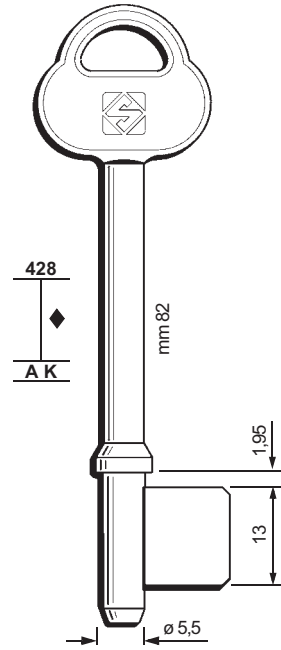

2AS19
40A/2440 Blank

FOR:

PER:

FAS - YALE

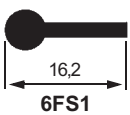
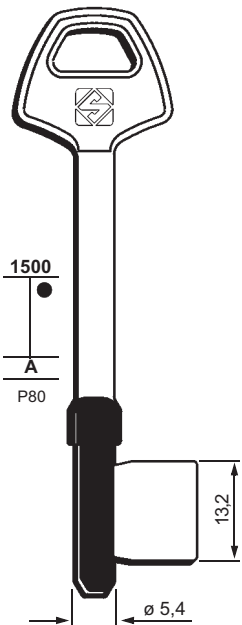

6FS1

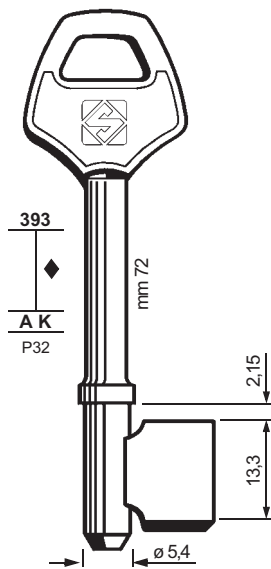

2FY1
309

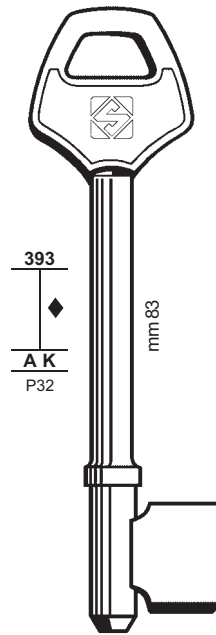

2FY2
309

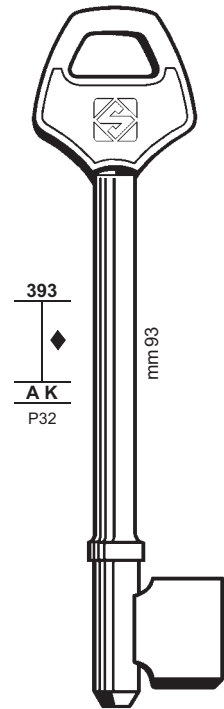

2FY3
309

FOR:
PER:

FAS - YALE

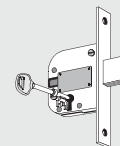

193

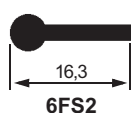
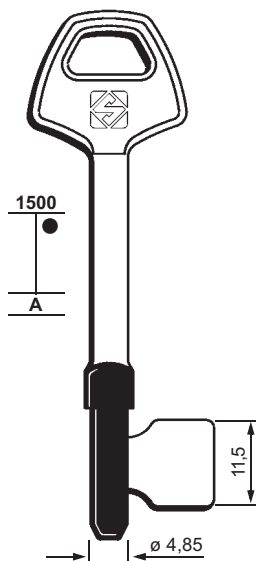

6FS2

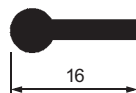
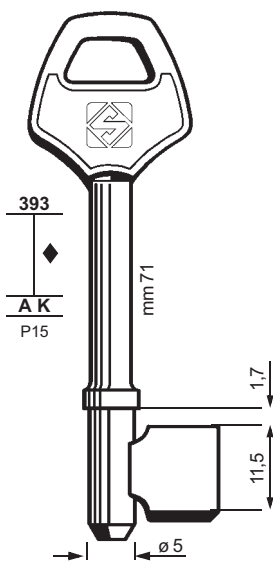

2FY4
131

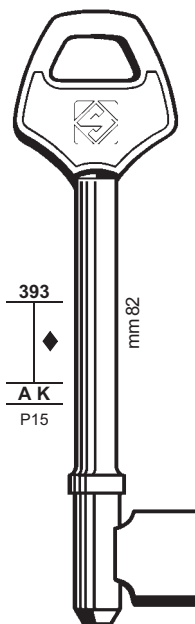

2FY5
131

FOR:
PER:

FAS - YALE

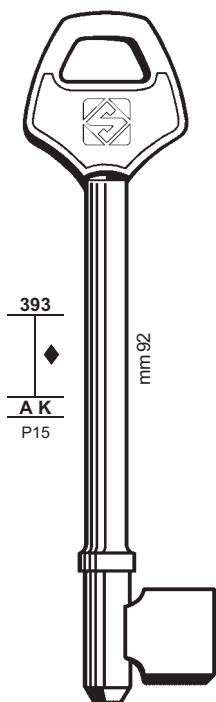

2FY6
131

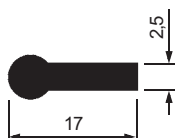
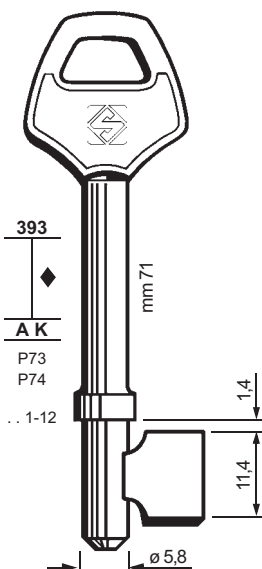

2FY7
40C

LÅSBOLAGET

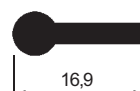
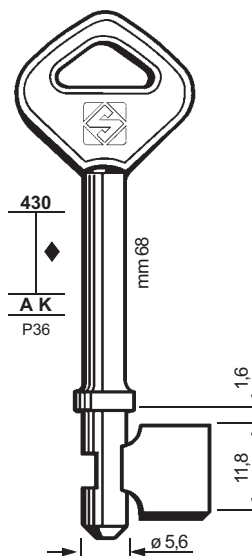

2LB1
40A/131

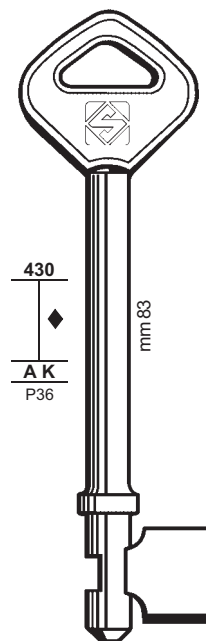

2LB2
40A/131

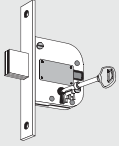

194

FOR:

PER:

LÅSBOLAGET

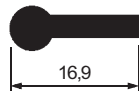
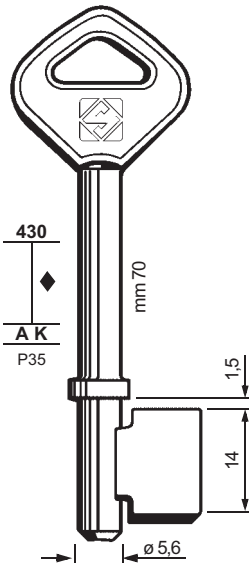

2LB4
9900

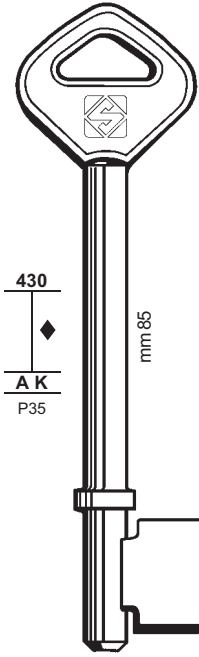

2LB5
9900

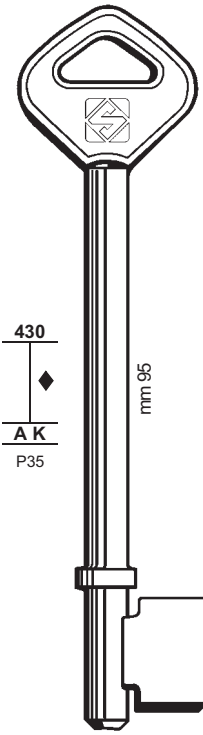

2LB6
9900

FOR:

PER:

LIPS

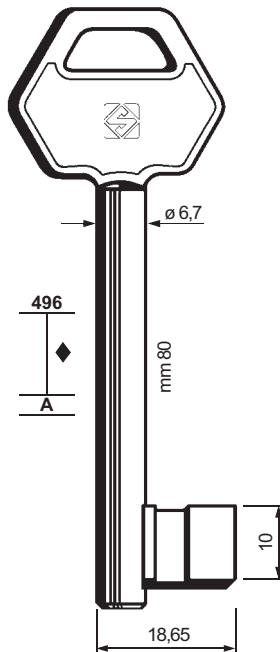

2LP2B

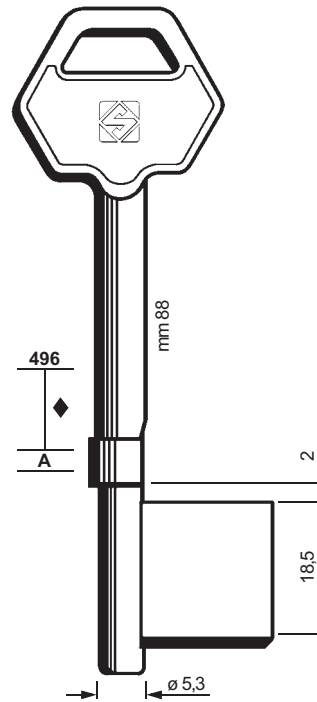

5867L



Index
Indice
Index
Index
Indice
Indice



**DOUBLE BIT AND PUMP KEYS INDEX - INDICE CHIAVI DOPPIA MAPPA E POMPA
DOPPELBART-UND PUMPENSCHLÜSSEL INDEX - INDEX CLÉS DOUBLE PANNETON ET À
POMPE - INDICE LLAVES DOUBLE MAPA Y BOMBA - ÍNDICE CHAVES DUPLO PALHETÃO
E BOMBA**

Ref.	Page
3	
3FMB01	41
5	
5A2	4
5A4	4
5A6	4
5A7	4
5ACM1	10
5ACM3	10
5ASS1	4
5AT1	5
5AT11AP	5
5AT13AP	5
5AT1P	5
5AT3	4
5AT5	4
5AT7	5
5AT9	5
5AU1	3
5AU3	3
5AU5	4
5AU7	3
5AU9	5
5AU11	5
5AU13	6
5BDA1	7
5BDA2	7
5BDA3	8
5BDA4	8
5BDA7	8
5BDA11	8
5BDE1	8
5BDE2	8
5BDE3	8
5BE1	7
5BE2	7
5BE3	6
5BE5	6
5BGA1	9
5BGA3	9
5BL1	7
5BUR1	9
5BUR2	9
5C4	13
5C6	13
5C8	12
5C9	12
5C11	12
5C14	13

Ref.	Page
5C15	11
5CB1	16
5CB2	16
5CB3	16
5CC2	16
5CC4	16
5CER2	33
5CER4	33
5CER5	39
5CER7	39
5CER9	33
5CER12	33
5CPR1	13
5CPR3	13
5CS1	14
5CS1P	14
5CS2	14-57
5CS2P	14
5CS3T	14
5CS4T	14
5CS6P	13
5CS8P	13
5CS10P	15
5CS12P	15
5CSS1	15
5CSS3	15
5CT1	16
5CT3	16
5CTA1	10
5DK1	19
5DUX2	19
5DVN2	20
5DVN4	20
5DVN5	20
5DVN6	20
5DVN7	20
5DVN8	20
5DVN9	20
5DVN10	20
5DVN10F	21
5DVN12	21
5DVN14	21
5DVN15	21
5DVN17	23
5DVN19	23
5DVN22	21
5DVN21	21
5DVN23	21
5DVN24	21
5DVN25	21
5DVN26	22
5DVN27	22

Ref.	Page
5DVN29	22
5DVN31	22
5DVN34	22
5DY1	19
5EB1	23
5EB2	23
5EL1	22
5ERV1	24
5ERV3	24
5ERV5	24
5EY1	25
5EY3	25
5EY5	25
5EY20	25
5EY22	25
5EY24	25
5EY32	25
5EZ1	26
5EZ2	26
5EZ4	26
5EZ6	26
5FAC1	27
5FAC3	27
5FC1	31
5FC4	31
5FE1	28
5FEB1	28
5FEB3	28-59
5FEB5	28-59
5FEB7	28
5FI1	30
5FI3	29
5FI5	29
5FI7	29
5FI9	29
5FI13	30
5FI15	30
5FI17	30
5FI19	30
5FI21	30
5FI23P	31
5FR1	28
5FT1	32
5FT2	32
5GMA1T	33
5HK1 ●	34
5HRM1	34
5ID3	34
5ID5	34
5ID7	34
5ID9	35
5ID11	35

Ref.	Page
5ID13	35
5IE1	36
5IE5	35
5IE7	35
5IE9	35
5IE11	35
5IT2	36
5IT3	36
5IT6	36
5IT8	36
5JW1	37
5K1	38
5KRB1	39
5KRB2	39
5KRC1	39
5KU1	39
5KY2	38
5KY4	38
5KY6	38
5KY7	38
5LV1	39
5LW1	40
5LW3	40
5ME1	40
5ME2	40
5ME3	40
5ME4	40
5MEM2	40
5MO2	41
5MS1	52
5MS3	52
5MS5	52
5MT2	42
5MT2F	42
5MT3	43
5MT3BP ●	43
5MT5	43
5MT5BP ●	43
5MT7	43
5MT7BP ●	43
5MT9	44
5MT9BP ●	44
5MT10	44
5MT10BP ●	44
5MT12	42
5MT12F	42
5MT14	42
5MT16	42
5MT18BP ●	45
5MT19BP ●	45
5MT21BP ●	43
5MT23T	45

● = New key blanks / Chiavi nuove / Neuer Schlüssel / Clés nouveaux / Llaves nuevas / Chaves novas



Ref.	Page
5MT26T	45
5MXM2	40
5OC1	47
5OC3	47
5OSL1	47
5PF1	51
5PF3	51
5PT1	49
5PT2	49
5PT3	49
5PT5	48
5PT7	50
5PT10	50
5PT11	48
5PT12	50
5PT13	49
5PT15	49
5PT18	50
5PT20	50
5PT21	49
5PT22	50
5PT24	48
5PTI1	48
5R2	17
5R3	19
5R6	19
5R7	17
5R9	18
5R11	18
5R12T	18
5R14	19
5R16	18
5RSG1	51
5RSG2	51
5RUS1	51
5SAB2	52
5SAB4	52
5SAB6P	52
5SAB8P	52
5SAS1	56
5SAS3	56
5SAS5	56
5SCM2	53
5SCM4	53
5SCM6	53
5SCM8	54
5SCM10	53
5SCM12	54
5SCM14	54
5SER1	55
5SER3	55
5SMA1	10

Ref.	Page
5SOL2	57
5SOL3	57
5SR2	56
5SR4	55
5SR5	55
5SR8	55
5STV1	57
5TSI1	58
5TSI3	58
5TU1	59
5TV1	59
5VT1	59
5VT2	59
5YA1	60
5YA4	60
5YA6	61
5YA8	61
5YA9P	61
5YA10P	61
5YA13P	61
5YA14P	61
5YA18P	61
5YA20	61
5YA22	61
5ZM2	61
7	
7150	27
7151	27
7308E	23
7606	32
7626	32
7655	32
7656	54
7657	55
7659	54
8	
8150	27
8151	27
8310TA	58
8355C	15
8370PA	47
8372TA	58
8384R	51
8385PA	47
8388C	15
8405	15
8606	32
8615	47
8626	32
8655	32

Ref.	Page
8656	54
8657	55
8659	54
8695SSL	57
8711	16
A	
A	3
AL	3
ALL	3
ALLT	3
AML	3
AP	3
APN	3
AUL	36
AUM	36
AUP	35
B	
BE	6
BE2	6
BE2P	6
BEA	7
BEAC	7
BEC	6
BEL	7
BELC	7
BES	6
BESC	6
BL	7
C	
C	11
CC	11
CCL	11
CCLQ	11
CF	9
CFL	9
CFN	9
CL	12
CLN	12
CLQ	13
CM	11
CN	12
CNC	12
CNCP	12
CNP	12
CP	12
CPC	10
CPN	10
CPP	11

Ref.	Page
CPV	10
CPX	10
CPXN	11
CQ	11
CS	14
CSC	14
CSCP	14
CSL	14
CSLC	14
CSLCP	14
CSLP	14
CSM	14
CSMC	14
CSMCP	14
CSMP	14
CSP	14
D	
DS	27
E	
E	24
EL	24
ELP	24
EM	53
EN	24
EP	26
EPN	26
EPP	26
EPT	26
F	
F	30
FD	27
FQ	28
FQC	29
FQL	29
FQM	29
FQN	29
FT7	32
FT8	32
FT9	32
FT11	32
FT12	32
FT14	32
FT500	31
FT500C	31
FT510	31
FT525P	32
FTN	30

● = New key blanks / Chiavi nuove / Neuer Schlüssel / Clés nouveaux / Llaves nuevas / Chaves novas



**DOUBLE BIT AND PUMP KEYS INDEX - INDICE CHIAVI DOPPIA MAPPA E POMPA
DOPPELBART-UND PUMPENSCHLÜSSEL INDEX - INDEX CLÉS DOUBLE PANNETON ET À
POMPE - INDICE LLAVES DOUBLE MAPA Y BOMBA - ÍNDICE CHAVES DUPLO PALHETÃO
E BOMBA**

Ref.	Page
G	
GBZ1	33
GBZ1P	33
GIC	34
GIL	34
GL	34
GP	34
GPN	34
I	
IDM	35
IPP	35-48
J	
JW20	37
JW35	37
JW35P	37
JW40	37
JW50	37
JW60	37
JW70	37
JW90	37
K	
KC	38-60
KL	38-56-60
KYL	38-60
KYP	38-60
M	
MC	41
ML	41
MT	41
MT2	41
MT2P	41
MT2RP	41
MT3	41
MT3P	41
MT3RP	41
MT4	41
MT4P	41
MT4RP	41
MTF	41
MTL	42
MTLF	42
MTM	42
MTMF	42

Ref.	Page
MTN	44
MTNBP ●	44
MTNC	44
MTNCBP ●	44
MU6-0	46
MU6-1	46
MU6-2	46
MU6-3	46
MU6-4	46
MU6-5	46
MU6-6	46
MU7-0	46
MU7-1	46
MU7-2	46
MU7-3	46
MU7-4	46
MU7-5	46
MU7-6	46
MU7-7	46
MU7-11	46
MU7-21	46
MU7-22	46
MU8-1	46
MU8-2	46
MU8-3	46
MU8-4	46
MU8-5	46
MU8-6	46
MU8-7	46
MU8-8	46
MU10-1	46
MU10-2	46
MU10-3	46
MU10-4	46
MU10-5	46
MU10-6	46
MU10-7	46
MU10-8	46
MU10-9	46
MU10-10	46
P	
P	48
PFF	50
PFM	50
PL	50
PLL	50
PO	49
POL	49
POP	48
PP	41
PTL	48

Ref.	Page
R	
R	17
RF	17
RFO	17
RGC	51
RL	18
RLC	19
RLCR	19
RLN	18
RM	17
RN	17
RP	17
RPC	17
S	
S	53
SB	53
SD	56
SDC	56
SDL	56
SDP	56
SE	52
SF	53-58
SM	53
SRP	55
SSP3	57
T	
TC	58
TL	58
TRL	59
TRP	59
W	
W	60
WM	60
Y	
YC	38-60

Ref.	Page
------	------

● = New key blanks / Chiavi nuove / Neuer Schlüssel / Clés nouveaux / Llaves nuevas / Chaves novas



PIN, MUZZLE AND "CADORINE" KEYS INDEX - INDICE CHIAVI A GORGES, GRUGNO E "CADORINE" - INDEX FÜR GORGES-, FAUST-UND CADORINESCHLÜSSEL - INDEX CLÉS À GORGES, GROIN ET CADORINE - INDICE LLAVES A GORGES, A PUNO Y "CADORINE" - ÍNDICE CHAVES DE GORGES, "GRUGNO" E "CADORINE"

Ref.	Page
0	
07PV	101
08PV	101
09PV	101
1	
10PV	101
13PV	101
14PV	101
15PV	101
16PV	101
17PV	101
18PV	101
1NFHL	101
10NFHL	101
2	
2NFHL	101
2UN2	106
2ZTG	109
3	
3FMB00	99
3NFHL	101
4	
4NFHL	101
5	
5106	117
5107	117
5108	117
5109	117
5110	117
5111	117
5112	117
5113	117
5113/1	118
5114	118
5114/1	118
5114/2	126
5115	118
5206	121
5207	121
5309	121
5411	121
5507	121
5508	115
5509	115

Ref.	Page
5510	115
5511	115
5511/1	116
5512	116
5513	116
5514	116
5601	121
5602	121
5609ALD	83
5611ALD	83
5703	123
5704	123
5807ALD2	83
5817	122
5818	122
5827	122
5828	122
5837	122
5838	122
5847	122
5848	122
5866	124
5867L	122
5870ALD1	83
5870ALD2	83
5901	123
5903	123
5908	123
5909	123
5910	123
5921	122
5922	122
5922P	122
5922P1	122
5922P2	122
5922P3	122
5922P4	122
5922P5	122
5922P6	122
5922P7	122
5922P8	122
5ACH1	85
5ACH3	85
5ACH4	85
5BDA5	86
5DD1P	89
5FH1P	91
5HS2	93
5JM1P	95
5JM2P	95
5LH1	97
5LH3	97

Ref.	Page
5NFHL	101
5PE1	102
5PE2	102
5PE3	102
5PE4	102
5PE5	102
5PX1P	102
5PX2P	102
5PX6P	102
5VP1	109
5VP2	109
5VP3	109
6	
6106	117
6107	117
6108	117
6109	117
6110	117
6112	117
6113	117
6113/1	118
6114	118
6114/1	118
6115	118
6206	121
6207	121
6309	121
6411	121
6506	121
6507	121
6507/1	121
6507/2	125
6507/4	125
6508	115
6509	115
6510	115
6511	115
6511/1	116
6512	116
6513	116
6514	116
6605	119
6606	119
6606ALD2	84
6606ALD3	84
6607	119
6608	119
6609	119
6610	119
6611	119

Ref.	Page
6612	120
6613	120
6614	120
6615	120
6750	125
6802	123
6803	123
6805	123
6806	123
6852	124
6853	124
6865	88
6866	124
6911V	100
6911-1V	100
6922P4	111
6966V	100
6975ALD	84
6988-2V	100
6988V	100
6998V	100
6ACU1	84
6AE1	83
6AS1	84
6ASS1	84
6ASS2	84
6BD1	87
6BDA1	86
6BDA2	86
6BDA3	86
6BDA4	86
6BDE1	87
6BDE2	87
6BDE3	87
6BDK1	87
6CHU2	88
6EL1	90
6EL2	90
6ER1	90
6F3	112
6F4	112
6F5	112
6F6	112
6F7	112
6F8	112
6F9	112
6F10	112
6F11	112
6F12	112
6F13	112
6F14	112
6F15	112

● = New key blanks / Chiavi nuove / Neuer Schlüssel / Clés nouveaux / Llaves nuevas / Chaves novas



Ref.	Page
6F16	112
6F17	112
6F18	112
6F19	112
6F20	112
6F21	112
6F22	112
6F23	112
6F24	112
6F25	112
6F26	112
6F27	112
6F28	112
6F29	112
6F30	112
6F31	111
6F34	111
6FT10	91
6FT12	91
6GPZ1	93
6HOB1	94
6HOB2	94
6HOB3	94
6HOB4	94
6HOB5	94
6HOB6	95
6HOB7	95
6HOB8	95
6HOB9 ●	94
6JM1	95
6JM1-1	95
6JM1-2	95
6JM1-6	95
6JM1-7	95
6JM1-8	95
6JM1-9	95
6JM1-10	95
6JM1-11	95
6JM1-12	95
6JM2	96
6JM3	96
6JM4	96
6JM5	96
6JM6	96
6KRN1	97
6LDN1	98
6LW2	98
6LZ1	98
6LZ2	98
6LZ3	98
6LZ4	98
6LZ5	98

Ref.	Page
6LZ5-1	98
6LZ5-2	98
6LZ5-3	98
6LZ5-4	98
6LZ5-5	98
6LZ5-6	98
6M1	110
6M2	110
6M3	112
6M4	112
6M5	112
6M6	112
6M7	112
6M8	112
6M9	112
6M10	112
6M11	112
6M12	112
6M13	112
6M14	112
6M15	112
6M16	112
6M17	112
6M18	112
6M19	112
6M20	112
6M21	112
6M22	112
6M23	112
6M24	112
6M25	112
6M26	112
6M27	112
6M28	112
6M29	112
6M30	112
6M32	112
6M35	112
6M36	113
6M37	113
6M38	113
6MAS1	99
6MBL1	99
6MF1	98
6MU1	99
6NFHL	101
6OG1	101
6ORG1	101
6ORG2	101
6RUS1	103
6SE1	103
6SE2	103

Ref.	Page
6SE3	103
6SV1	103
6TR1-7	106
6TR1-8	106
6TR1-9	106
6TR1-10	106
6TR1-11	106
6TR1-12	106
6TR2	106
6TR3	106
6TR5	106
6TR6	106
6VAC1	108
6VAC1-1	108
6VAC1-2	108
6VAC1-6	108
6WG1	109
6WG1-01	109
6WG1-02	109
6WG1-1	109
6WG1-2	109
6WG1-3	109
6WG1-4	109
6WG1-5	109
6WG1-6	109
6WG2	109
6YA1	109
7	
7NFHL	101
7ZTG	109
8	
8NFHL	101
9	
9102	125
9107	125
9202	125
9207	125
9247	124
9404	125
9407	124
9510	124
9575	124
9584	124
9585	124
9600	125
9601	125
9706	126

Ref.	Page
9707	126
9755	126
9911S	104
9911S-K1	104
9911S-K2	104
9911S-K3	104
9911S-K4	104
9911S-K5	104
9911S-K6	104
9911S-K7	104
9911S-K8	104
9911S-K9	104
9911S-K10	104
9911S-K11	104
9911S-K12	104
9911S-O1	105
9911S-O2	105
9911S-O3	105
9911S-O4	105
9911S-O5	105
9911S-O6	105
9911S-O7	105
9911S-O8	105
9911S-O9	105
9911S-O10	105
9911S-O11	105
9911S-O12	105
9911S-O13	105
9911S-O14	105
9911S-O15	105
9NFHL	101
A	
ACH	85
B	
BD600	87
BD604	87
BD700	87
BD700-1	87
BD700-2	87
BD700-3	87
BD700-4	87
BD700-5	87
BD700-6	87
C	
CHC	88
CHL	88
CHU5	85
CHU7	85
CRE401	88

● = New key blanks / Chiavi nuove / Neuer Schlüssel / Clés nouveaux / Llaves nuevas / Chaves novas



PIN, MUZZLE AND "CADORINE" KEYS INDEX - INDICE CHIAVI A GORGES, GRUGNO E "CADORINE" - INDEX FÜR GORGES-, FAUST-UND CADORINESCHLÜSSEL - INDEX CLÉS À GORGES, GROIN ET CADORINE - INDICE LLAVES A GORGES, A PUNO Y "CADORINE" - ÍNDICE CHAVES DE GORGES, "GRUGNO" E "CADORINE"

Ref.	Page
CRE402	88
CRE403	88
CRE404	88
CRE405	88
CRE406	88
CU402	88
CU405	88
CU413	88
E	
EY300	90
G	
G6-1	114
G6-2	114
G6-9	114
G6-10	114
G6-13	114
G6-14	114
G6-15	114
G6-16	114
G6-19	93
G6-20	93
G6-21	114
G6-22	114
G6-31	114
G6-32	114
G6-37	114
G6-38	114
G6-41	114
G6-42	114
G6-53	114
G6-54	114
G6-55	114
G6-56	114
G6-57	114
G6-58	114
G6-69	114
G6-70	114
G6-81	114
G6-82	114
G6-99	114
G6-100	114
G6-109	114
G6-110	114
G6-121	114
G6-122	114
G6-145	114
G6-146	114
G6-161	114
G6-162	114
G6-173	114

Ref.	Page
G6-174	114
G6-183	114
G6-184	114
G6-217	114
G6-218	114
G6-235	114
G6-236	114
G6-263	114
G6-264	114
G6-273	114
G6-274	114
G6-285	114
G6-286	114
G6-287	114
G6-288	114
G8N-0	85
G8N-1	85
G8N-2	85
G8N-3	85
G8N-4	85
G8N-5	85
G8N-6	85
G8N-7	85
G8N-8	85
G8N-9	85
G71-13 1/2	86
G71-15 1/2	86
G71-17 1/2	86
G71-19 1/2	86
G71-21 1/2	86
G71-23 1/2	86
G71-27 1/2	86
G71-31 1/2	86
G176	93
G662	113
G685	113
GE700-1	92
GE700-2	92
GE700-4	92
GE700-5	92
GE700-6	92
GE700-8	92
GE700-12	92
GE700-14	92
GE700-15	92
GE700-17	92
GE700-19	92
GE700-21	92
GE700-22	92
GE700-23	92
GE700-24	92
GE700-25	92

Ref.	Page
GE700-27	92
GE700-28	92
GE700-29	92
GE700-30	92
GE700-32	92
GE700-33	92
GE700-34	92
GE700-35	92
GE700-36	92
GE700-38	92
GE700-39	92
GE700-40	92
GE700-41	92
GE700-42	92
GE700-43	92
GE700-44	92
GE700-45	92
GE700-47	92
GE700-48	92
GE700-49	92
GE700-51	92
GE700-52	92
GE700-53	92
GE700-54	92
GE700-55	92
GE700-56	92
GE700-57	92
GE700-58	92
GE700-59	92
GE700-60	92
G707	111
G713	113
GLT703L	93
GLT706L	93
GLT709L	93
GLT710L	93
J	
JM600L	96
JM710L-1	96
JM710L-2	96
JM710L-3	96
JM710L-4	96
JM710L-5	96
JM710L-6	96
JM710L-7	96
JM710L-8	96
JM710L-9	96
JM710L-10	96
JM710L-11	96
JM710L-12	96

Ref.	Page
L	
LC	98
LH700	97
LH701	97
LH710L	97
LH710L-3	97
LH710L-4	97
LH710L-5	97
LH710L-6	97
LH710L-9	97
LH710L-10	97
LOTUS1	110
LOTUS2	110
LOTUS3	110
LOTUS4	110
M	
M9H	107
M10H	107
M11H	107
M12H	107
M13H	107
M14H	107
M15H	107
M16H	107
M17H	107
M18H	107
M20H	107
M21H	107
M22H	107
M23H	107
M24H	107
M25H	107
M26H	107
M27H	107
M28H	107
M29H	107
M30H	107
M31H	107
M32H	107
M33H	107
M34H	107
M35H	107
M36H	107
M37H	107
M38H	107
M39H	107
M40H	107
MBS300	99

● = New key blanks / Chiavi nuove / Neuer Schlüssel / Clés nouveaux / Llaves nuevas / Chaves novas



Ref.	Page
MBS301	99
MU401	99
MU402	99
MU403	99
MU404	99
N	
ND704L	90
ND706L	90
ND740L	90
ND740L-1	90
ND740L-4	90
ND740L-5	90
ND740L-6	90
ND740L-7	90
ND740L-8	90
ND740L-9	90
ND740L-10	90
ND760L-1	89
ND760L-2	89
ND760L-3	89
ND760L-4	89
ND760L-5	89
ND760L-6	89
ND760L-7	89
ND760L-8	89
ND760L-9	89
ND760L-10	89
ND760L-11	89
ND760L-12	89
ND760L-17	89
ND760L-18	89
ND760L-19	89
ND760L-20	89
ND760L-21	89
ND760L-22	89
ND760L-27	89
ND760L-28	89
ND760L-29	89
ND760L-30	89
ND760L-63	89
ND760L-64	89
ND760L-73	89
ND760L-74	89
ND760L-75	89
ND760L-76	89
ND760L-79	89
ND760L-80	89
ND760LC-10	89
ND760LC-18	89
ND760LC-19	89
ND760LC-20	89

Ref.	Page
ND760LC-29	89
ND760LC-30	89
P	
PIC710L-1	102
PIC710L-2	102
PIC710L-3	102
PIC710L-4	102
PIC710L-5	102
PIC710L-6	102
PIC710L-7	102
PIC710L-8	102
PIC710L-9	102
PIC710L-10	102
PIC710L-11	102
PIC710L-12	102
PIC710L-13	102
PIC710L-14	102
PIC710L-15	102
PIC710L-16	102
PIC710L-17	102
PIC710L-18	102
PIC710L-19	102
PIC710L-20	102
PIC710L-21	102
PIC710L-22	102
PIC710L-23	102
PIC710L-24	102
PIC710L-25	102
PIC710L-26	102
PIC710L-27	102
PIC710L-28	102
PIC710L-29	102
PIC710L-30	102
PIC710L-31	102
PIC710L-32	102
R	
RF700	103
RS601	103
RS602	103
RS603	103
RS604	103
RS615	103
RS616	103
RS617	103
V	
VAC301	108
VAC302	108

Ref.	Page
VAC303	108
VAC304	108
VAC305	108
VAC306	108

Ref.	Page
------	------

● = New key blanks / Chiavi nuove / Neuer Schlüssel / Clés nouveaux / Llaves nuevas / Chaves novas



Ref.	Page
0	
07PV	159
08PV	159
09PV	159
1	
1AGB	129
1CC	141
1CCG	140
1CCN	139
1CCP	133
1GBG	132
1GBP	131
1MGC	147
1MPN	143-148
1MPV	149
1NFHL	151
1OS	152
1OSM	153
1PGP	154
1SGB	162
1SMT	156
1STB	163
1STC	161
10AGB	129
10CC	141
10CCG	140
10CCN	139
10CCP	133
10GBG	132
10GBP	131
10IE	155
10MPN	143-148
10MPV	149
10NFHL	151
10OS	152
10OSM	153
10PGP	154
10SGB	162
10SMT	156
10STB	163
10STC	161-165
10STQ	157
10PV	159
11AGB	129
11CC	141
11CCG	140
11CCN	139
11CCP	133
11GBG	132

Ref.	Page
11GBP	131
11IE	155
11MPN	143-148
11MPV	149
11MV	146
11PGP	154
11SGB	162
11STB	163
11STC	161
12AGB	129
12CC	141
12CCG	140
12CCN	139
12CCP	134
12GBG	132
12GBP	131
12IE	155
12MPN	143-148
12MPV	149
12MV	146
12PGP	154
12SGB	162
12STB	163
12STC	161
13CC	141
13CCG	140
13CCN	139
13CCP	133
13IE	155
13MPN	148
13MPV	149
13PV	159
13STB	163
14CC	141
14CCG	140
14CCN	139
14CCP	134
14IE	155
14MPN	148
14MPV	149
14PV	159
14STB	163
15CC	141
15CCG	140
15CCN	139
15CCP	137
15MPN	148
15MPV	149
15PV	159
16CC	141
16CCG	140
16CCN	139

Ref.	Page
16CCP	138
16MPN	148
16MPV	149
16PV	159
17CC	141
17CCG	140
17CCN	139
17CCP	135
17MPV	149
17PV	159
18CC	141
18CCG	140
18CCN	139
18CCP	136
18MPV	149
18PV	159
19CC	142
19CCP	135
2	
2AGB	129
2CC	141
2CCG	140
2CCN	139
2CCP	134
2GBG	132
2GBP	131
2MGC	147
2MPN	143-148
2MPV	149
2MV	146
2NFHL	151
2OS	152
2OSM	153
2PGP	154
2SGB	162
2SMT	156
2STB	163
2STC	161
20CC	142
20CCP	136
21CC	142
21CCP	134
22CC	142
22CCP	133
23CC	142
23CCP	133
24CC	142
24CCP	134
25CC	142
26CC	142

Ref.	Page
27CC	142
28CC	142
29CC	142
3	
3AGB	129
3CC	141
3CCG	140
3CCN	139
3CCP	137
3GBG	132
3GBP	131
3MGC	147
3MPN	148
3MPV	149
3MV	146
3NFHL	151
3OS	152
3OSM	153
3PGP	154
3SGB	162
3SMT	156
3STB	163
3STC	161
30CC	142
31CC	142
32CC	142
33CC	142
34CC	142
35CC	142
36CC	142
4	
4AGB	129
4CC	141
4CCG	140
4CCN	139
4CCP	138
4GBG	132
4GBP	131
4MGC	147
4MPN	148
4MPV	149
4NFHL	151
4OS	152
4OSM	153
4PGP	154
4SGB	162
4SMT	156
4STB	163

● = New key blanks / Chiavi nuove / Neuer Schlüssel / Clés nouveaux / Llaves nuevas / Chaves novas



Ref.	Page
4STC	161
5	
5AGB	129
5CC	141
5CCG	140
5CCN	139
5CCP	135
5GBG	132
5GBP	131
5IE	155
5MGC	147
5MPN	143-148
5MPV	149
5MV	146
5NFHL	151
5OS	152
5OSM	153
5PGP	154
5SGB	162
5SMT	156
5STB	163
5STC	161
5STQ	157
5002	160-163
5005C	158
5006C	158
5007EK ●	159
5008EK ●	159
5009	158
5010	158
5011	158
5012	158
5018MP	150
5601	159
5602	159
6	
6AGB	129
6CC	141
6CCG	140
6CCN	139
6CCP	136
6EK1	144-168
6EK2	144-168
6EK3	144-168
6EK4	144-168
6EK5	144-168
6EK6	144-168
6EK7	144-168
6EK8	144-168

Ref.	Page
6EK9	144-168
6EK10	144-168
6EK11	144-168
6EK12	144-168
6GBG	132
6GBP	131
6IE	155
6MGC	147
6MPN	143-148
6MPV	149
6MV	146
6NFHL	151
6OS	152
6OSM	153
6P1D	129-143 148-166
6P1MP	129-143-148 153-156-166
6P1S	129-143 148-166
6P2D	131-146-152 154-157-166
6P2MP	131-146-152 154-157-166
6P2S	131-146-152 154-157-166
6P3D	132-149 155-166
6P3S	132-149 155-166
6P4MP	147-168
6P5MP	162-168
6P6MP	160-163-168
6P7D	161-164-167
6P7S	161-165-167
6P8D	139-140 141-142-167
6P8D-1	139-140 141-142-167
6P8D-2	139-140 141-142-167
6P8D-3	139-140 141-142-167
6P8D-4	139-140 141-142-167
6P8S	139-140 141-142-167
6P8S-1	139-140 141-142-167
6P8S-2	139-140 141-142-167

Ref.	Page
6P8S-3	139-140 141-142-167
6P8S-4	139-140 141-142-167
6P9MP	150-168
6P10D	133
6P10D-1	135
6P10D-2	137
6P10S	134
6P10S-1	136
6P10S-2	138
6PGP	154
6SGB	162
6SMT	156
6STB	163
6STC	161
6STQ	157
7	
7AGB	129
7CC	141
7CCG	140
7CCN	139
7CCP	135
7GBG	132
7GBP	131
7IE	155
7MPN	143-148
7MPV	149
7NFHL	151
7OS	152
7OSM	153
7PGP	154
7SGB	162
7SMT	156
7STB	163
7STC	161-164
7STQ	157
8	
8AGB	129
8CC	141
8CCG	140
8CCN	139
8CCP	136
8GBG	132
8GBP	131
8IE	155
8MPN	143-148
8MPV	149
8MV	146

Ref.	Page
8NFHL	151
8OS	152
8OSM	153
8PGP	154
8SGB	162
8SMT	156
8STB	163
8STC	161-165
8STQ	157
9	
9AGB	129
9CC	141
9CCG	140
9CCN	139
9CCP	134
9GBG	132
9GBP	131
9IE	155
9MPN	143-148
9MPV	149
9MV	146
9NFHL	151
9OS	152
9OSM	153
9PGP	154
9SGB	162
9SMT	156
9STB	163
9STC	161-164
9STQ	157
A	
A1GB56C	164
A2GB56C	164
A3GB56C	164
A4GB56C	164
A5GB56C	164
A6GB56C	164
A7GB56C	164
A8GB56C	164
A9GB56C	164
A10GB56C	164
A11GB56C	164
A12GB56C	164
A13GB56C	164
A14GB56C	164

● = New key blanks / Chiavi nuove / Neuer Schlüssel / Clés nouveaux / Llaves nuevas / Chaves novas



Ref.	Page
B	
B1GB56C	165
B2GB56C	165
B3GB56C	165
B4GB56C	165
B5GB56C	165
B6GB56C	165
B7GB56C	165
B8GB56C	165
B9GB56C	165
B10GB56C	165
B11GB56C	165
B12GB56C	165
B13GB56C	165
B14GB56C	165
C	
C1GB56C	164
C2GB56C	164
C3GB56C	164
C4GB56C	164
C5GB56C	164
C6GB56C	164
C7GB56C	164
C8GB56C	164
C9GB56C	164
C10GB56C	164
C11GB56C	164
C12GB56C	164
C13GB56C	164
C14GB56C	164
D	
D1GB56C	165
D2GB56C	165
D3GB56C	165
D4GB56C	165
D5GB56C	165
D6GB56C	165
D7GB56C	165
D8GB56C	165
D9GB56C	165
D10GB56C	165
D11GB56C	165
D12GB56C	165
D13GB56C	165
D14GB56C	165

Ref.	Page
G	
G8N-0	130
G8N-1	130
G8N-2	130
G8N-3	130
G8N-4	130
G8N-5	130
G8N-6	130
G8N-7	130
G8N-8	130
G8N-9	130
G71-13 1/2	130
G71-15 1/2	130
G71-17 1/2	130
G71-19 1/2	130
G71-21 1/2	130
G71-23 1/2	130
G71-27 1/2	130
G71-31 1/2	130
GE700-1	145
GE700-2	145
GE700-4	145
GE700-5	145
GE700-6	145
GE700-8	145
GE700-12	145
GE700-14	145
GE700-15	145
GE700-17	145
GE700-19	145
GE700-21	145
GE700-22	145
GE700-23	145
GE700-24	145
GE700-25	145
GE700-27	145
GE700-28	145
GE700-29	145
GE700-30	145
GE700-32	145
GE700-33	145
GE700-34	145
GE700-35	145
GE700-36	145
GE700-38	145
GE700-39	145
GE700-40	145
GE700-41	145
GE700-42	145
GE700-43	145

Ref.	Page
GE700-44	145
GE700-45	145
GE700-47	145
GE700-48	145
GE700-49	145
GE700-51	145
GE700-52	145
GE700-53	145
GE700-54	145
GE700-55	145
GE700-56	145
GE700-57	145
GE700-58	145
GE700-59	145
GE700-60	145
L	
LH710L	145
LH710L-3	145
LH710L-4	145
LH710L-5	145
LH710L-6	145
LH710L-9	145
LH710L-10	145
M	
MP4L-A	150
MP4L-B	150
MP4L-C	150
MP4L-D	150
MP4L-E	150
MP4L-F	150
MP4L-G	150
MP4L-H	150
MP4L-I	150
MP4L-L	150
N	
ND740L	144
ND740L-1	144
ND740L-4	144
ND740L-5	144
ND740L-6	144
ND740L-7	144
ND740L-8	144
ND740L-9	144
ND740L-10	144

Ref.	Page
------	------

● = New key blanks / Chiavi nuove / Neuer Schlüssel / Clés nouveaux / Llaves nuevas / Chaves novas



Ref.	Page
3	
3F1033	176
3F1042	176
3F1140	176
3F1150	176
3F1232	177
3F1242	177
3F1530	177
3F1540	177
3F1630	177
3F1640	177
3F1730	177
3F1738	177
3F2233	177
3F2532	177
3F2542	177
3F2630	178
3F2635	178
3F2640	178
3F2681	175
3F2830	178
3F2840	178
3F2933	178
3F2942	178
3F3032	178
3F3042	178
3F3081	175
3F3235	178
3F3242	178
3F3335	178
3F3340	178
3F3381	175
3F3530	179
3F3540	179
3F3735	179
3F3930	179
3F4135	179
3F4145	179
3F4333	179
3F4342	179
3F4433	179
3F4445	179
3F4535	180
3F4542	180
3F4735	180
3F4742	180
3F4781	176
3F4832	180
3F4842	180
3F4881	176

Ref.	Page
3F4935	180
3F4945	180
3F5233	180
3F5242	180
3F5432	180
3F5442	180
3F5635	180
3F5645	180
3F5745	180
3F5942	181
3F6025	181
3F6081	176
3F6932	181
3F6942	181
3F7132	181
3F7142	181
3F7330	181
3F7340	181
3F7430	181
3F7440	181
3FB00	172
3FEU00	172
3FGE00	172-173
3FGE01	173
3FGE02	173
3FGE03	173
3FGE04	173
3FGE05	173
3FGE06	173
3FGE10	173
3FGE20	173
3FGE30	173
3FGE40	173
3FMB02	173
3FMB03	173
3FMB03-1	174
3FMB03-2	174
3FMB03-3	174
3FMB03-4	174
3FMB03-5	174
3FMB03-6	174
3FMB04	173
3FMB04-1	174
3FMB04-2	174
3FMB04-3	174
3FMB04-4	174
3FMB04-5	174
3FMB04-6	174
3FMB05	173
3FMB06	173
3FRF01	175
3FRF02	175

Ref.	Page
3FRF03	175
3FRF04	175
3FRF05	175
3FRF06	175
3FRF100	174
3FRF200	174
3M1630	184
3M1725	184
3M1735	184
3M2127	184
3M2136	184
3M2630	184
3M2734	184
3M3437	184
3M4030	184
3M5925	184
3P16	186
3P17	186
3P31	186
3P32	186
3P43	186
3PS1	186
3S1332	182
3S1342	182
3S1832	182
3S1842	182
3S2032	182
3S2042	182
3S2332	182
3S2342	182
3S3632	182
3S3642	182
3S4232	182
3S4242	182
3S4632	183
3S4642	183
3S5032	183
3S5042	183
3S5132	183
3S5142	183
3S5332	183
3S5342	183
3S7032	183
3S7042	183
3S7232	183
3S7242	183
3T16	185
3T17	185
3T26	185
3T29	185
3T30	185
3T33	185

Ref.	Page
3T43	185
3T44	185
3T47	185
3T48	185
3T52	185
3T54	185
3T57	185
5	
5507	171
5703	171
5704	171
6	
6506	172
6507	171
6507/1	172
6507/3	172
6802	171
6803	171
6805	171
6806	171

● = New key blanks / Chiavi nuove / Neuer Schlüssel / Clés nouveaux / Llaves nuevas / Chaves novas



Brand	Page
4 TR	59
ADATTABILI	175-176
AGB	129
ALDRIDGE	83
ALEDAL	83-84
ANTONIOLI	3-4
ARCU	84
ASSA	4-70-84-189 190-191-192
ATRA	4-5
AUNO	5-6
AVA-CHUBB	85
BETA	6-7
BKS	85-86-130
BMC	7
BODA	7-8-86
BODE	8-65-67-87
BOGATIR	9
BONAITI - "GB"	131-132
BRANDTEK	87
BRICARD	87
BURG-WÄCHTER	9
CAF	9
CAM	10
CECCHERELLI	69
CENATA	10
CERUTTI	10-11-12-13
CHIAVI ADATTABILI - FEMMINE A GORGES	111-112
CHIAVI ADATTABILI - MASCHI A GORGES	110-112
CHUBB	88
CIPIERRE	13
CIS	88
CISA	13-14-15
CLASS	15
CONFORTI	15-16-71-72-73
CORBIN	16-76 16-133-134-135
CORNI	136-137-138-139 140-141-142-143
COUILLET	88
C.R.	17-18-19
CUIRASSEE	88
DAD-DECAYEUX	89
DEBEAURAIN	89-90-144
DEKABA	19
DENY	19
DUPLEX	19
DUTO	77-78
DVERNIAK	20-21-22
ELBOR	23

Brand	Page
ELZETT	22-23-70-90
EMERY	90
ERA	90
EREVAN	24
ESETY	24-25-26
EUREKA	144
EURO	172
EZCURRA	26
FAC	27
FACEF-DOMUS	27
FAS - YALE	192-193
FASTA	27-67
FEB	28
FEMMINE	125
FEMMINE A GORGES	111
FEMMINE FIRENZE	119-120
FEMMINE MIGNON PER MOBILI IN STILE	184
FEMMINE PER MOBILI	172
FEMMINE PER MOBILI - GEGE	173
FEMMINE PER MOBILI - MOBELLA	173-174
FEMMINE PER MOBILI - REFORM	174-175
FEMMINE PER MOBILI IN STILE	175-176-177 178-179-180-181
FEMMINE SNODATE PER MOBILI IN STILE	182
FEMMINE SNODATE PER MOBILI IN STILE	183
FERRAMETALL	28
FETIS	28
FIAM	28-29-30-31
FIAMCA	31
FICHET	31-32-91
FTH	91
FUMEO	32
FUMEO-PARMA	66-69
GB2	33
GEGE	92-145-172
GERION	33
GIMAST	33
GIPIS	34
GLITTENBERG	65-93
GMG	34
GOLLOT	93
GPZ	93
HAGELIN	66
HEERUM	34

Brand	Page
HELASON	93
HK	34
HOBES	94-95
IDM	34-35
IMSI	35
ISEO	35-36
ITAL	36
JPM	95-96
JUWEL	37
KASSEL	38
KERBEROS	39
KREPICH	39
KROMER	67
KROMNI	97
KURZEMES	39
LAPERCHE	97-145
LAPP-FINZE	98
LÄSBOLAGET	193-194
LAUDON	98
LINCE	98
LIPS	194
LIPS-VAGO	39-71
LOWE & FLETCHER	40-98
MAFOR	98
MARSTON	99
MASCHI	126
MASCHI A GORGES	113-114
MASCHI CON CORONA	122
MASCHI E FEMMINE	121-124
MASCHI E FEMMINE A GORGES	115-116
MASCHI E FEMMINE CON MAZZETTA	117
MASCHI E FEMMINE CON MAZZETTA	118
MASCHI E FEMMINE DA CASSETTO	123
MASCHI E FEMMINE PER CASSAFORTE	65-66-67-68-69 70-71-72-73-74 75-76-77-78-79
MASCHI E FEMMINE PER MOBILI	121-171
MASCHI E FEMMINE PER SERRANDA	125
MASCHI PER CANCELLETTO	122
MASCHI SERIE SPECIALE	124
MASCHI TIPO PIEMONTE	123

● = New key blanks / Chiavi nuove / Neuer Schlüssel / Clés nouveaux / Llaves nuevas / Chaves novas

**BRAND INDEX - INDICE PER MARCA - MARKEN INDEX - INDEX POUR MARQUES - INDICE PARA MARCA - INDICE DE MARCA**

Brand	Page
MASCHI TIPO	125
TRIESTE	
MAVE	146
MAXIM	40
MELSMETALL	40-66-73
METTEM	40
MG-MONTI	147
MOBELLA	41-99
MOIA	41
MOTTURA	41-42-43-44-45
MP	148
MP	149
MP 4 LEVE	150
MUEL	46-99
NEMEF	100-101-151
OASA	152
OMEC	47
ORENGO	101
OSLA	47
OSMET	153
OSTERTAG	101
PARMA	76
PARMA-PAS	47-72-78
PATENT	101-168
PATENT MAPPA PIENA	159-160-168
PATENT PASSEPARTOUT	158-159-166-167
PATENT TIPO VECCHIO	159
PATRONE	48
PERINO	154
PETTITI	48
PICARDIE	102
POLLUX	102
POTENT	48-49-50
PREFER	50-51
PROGRES	102
REFORM	103
R.G.	51
ROLEX	51-73
ROSENGREN	51-71
RUBIS	103
RUSSIA	51-103
SAB	52
SAFE	52
SEA	52
SECURCASA	72
SECUREMME	53-54
SECURITAS	65
SELECT	103

Brand	Page
SELLA & VALZ	54-55-68
SERCAP	55
SERMEC	55-56
SERRATURE BRONZATE E DA CANTINA	162-163
SERRATURE DA CANTINA	161
SERRATURE DA PORTONCINO BONAITI "GB"	164-165
SERRATURE PATENT	186
SIAS	56
SIBI	70
SIDERAL	56
SINA	155
SIS	57
SMET	156
SOLID	57-67
SPERRZEUGE	104-105
STAVER	57
STIEHM	65-69-74-75
STIQUAM	157
STUV	103
STUV-TANN	70
SWEDEN	57-66
TANN	58
TESIO	58
TESTE CHIAVI	185
TITANO	58
TO	58
TOVER	59
TRIOVING	106
TUSHINO	59
UNION	106
UNION	107
VACHETTE	108
VIGIE PICARD	109
VILDETA	59
VIRO	59
WELKA	60
WERTHEIM	79
WG	109
YALE	60-61-109
ZIME	61
ZORATTO	109

Brand	Page
-------	------

● = New key blanks / Chiavi nuove / Neuer Schlüssel / Clés nouveaux / Llaves nuevas / Chaves novas



GB IMPORTANT

All information and illustrations in this catalogue are for guidance only.

Silca reserves the right to alter products designs, dimensions or info to improve the products quality.

The contents of this catalogue are fully protected by Copyright and may not be copied or reproduced in any form, without written permission from Silca.

Any infringements will be dealt with under Italian law.

F IMPORTANT

Les illustrations et les caractéristiques techniques des produits présentés dans ce catalogue sont données à titre indicatif.

Bien que les caractéristiques essentielles des produits soient invariables, Silca se réserve le droit d'apporter toutes les modifications qu'elle retiendra nécessaires et opportunes afin d'améliorer la qualité de ses produits.

Tous les dessins et photos sont propriété Silca et toute reproduction, même partielle, sans l'autorisation écrite préalable de Silca est interdite conformément aux prescriptions légales. Tout litige est du ressort exclusif des Tribunaux de la circonscription où se trouve le Siège de la Société.

I IMPORTANT

Le illustrazioni e i dati tecnici dei prodotti contenuti nel catalogo debbono considerarsi indicativi.

Silca si riserva il diritto, ferme restando le caratteristiche essenziali dei prodotti, di apportare tutte le modifiche che ritiene necessarie e opportune al fine di migliorare la qualità dei prodotti.

Tutti i disegni e le fotografie sono di proprietà di Silca, ogni riproduzione anche parziale, senza autorizzazione scritta della Silca è vietata secondo termini di legge.

Per qualsiasi controversia competenti sono gli Uffici Giudiziari dove ha sede l'Azienda, con espressa esclusione di qualsiasi altro foro.

E IMPORTANTE

Las ilustraciones y los datos técnicos de los productos en este catálogo son indicativos.

La Silca se reserva el derecho, quedando invariadas las características principales de los productos, de modificar todo lo que considere necesario y oportuno para mejorar la calidad de sus artículos.

Todos los dibujos y las fotografías pertenecen a la Silca; según determina la Ley, se prohíbe toda reproducción aunque parcial, sin autorización por escrito de la Silca.

En caso de disputas la competencia es de las autoridades judiciales donde está domiciliada la firma, excluyendo cualquier otro foro.

D WICHTIG

Die Abbildungen und technischen Daten des Katalogs sind nur zur Information.

Silca behält sich vor, etwaige Änderungen am Produkt, die zur Verbesserung desselben beitragen vorzunehmen.

Alle Zeichnungen und Fotos sind Besitz der Firma Silca, jede Reproduktion, auch teilweise, ist ohne schriftliche Erlaubnis der Firma Silca gesetzlich untersagt.

Im Falle von Streitfragen ist der Gerichtshof des Firmensitzes zuständig; jeder andere Gerichtshof ist ausgeschlossen.

P IMPORTANTE

As ilustrações e as características técnicas dos produtos apresentados neste catálogo são facultados a título indicativo.

Mesmo que as características essenciais dos produtos sejam invariáveis, à Silca reserva-se o direito de modificar ser necessário e oportuno los productos, afim de melhorar a sua qualidade.

Todos os desenhos e fotos são propriedade da Silca, e é proibida a sua reprodução mesmo parcial sem a autorização escrita da Silca conforme as prescrições legais.

Em caso de litígio fica desde já designado, excluindo qualquer outro, o Tribunal da comarca onde está registada a sede da Silca.

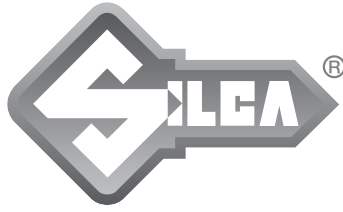
**GB IMPORTANT**

In compliance with current regulations relating to industrial property, we hereby state that the trade-marks or trade names mentioned in our catalogue are the exclusive property of authorized manufacturers of locks and users.

Said trade-marks or trade names are nominated only for the purposes of information so that any lock for which our keys are made can be rapidly identified. This catalogue is reserved exclusively for professional key cutters who use Silca products.

F IMPORTANT

Conformément aux lois en vigueur concernant la propriété industrielle, nous vous informons que les marques et appellations commerciales citées dans notre catalogue appartiennent exclusivement aux fabricants de serrures et aux utilisateurs autorisés.

Ces marques ou appellations commerciales sont indiquées à titre d'information pure et simple pour vous permettre de déterminer rapidement les serrures auxquelles nos clés sont destinées.

Ce catalogue est réservé exclusivement aux professionnels du taillage de clés qui utilisent les produits Silca.

I IMPORTANT

In conformità alle disposizioni legali in vigore relative alle proprietà industriali, informiamo che i marchi o le denominazioni commerciali citate nel nostro catalogo sono di proprietà esclusiva dei fabbricanti di serrature e degli utilizzatori autorizzati.

Questi marchi o denominazioni commerciali sono indicati a titolo di semplice informazione, con lo scopo di riconoscere velocemente a quali serrature le nostre chiavi sono destinate. Questo catalogo è esclusivamente riservato ai professionisti della riproduzione chiavi che utilizzano i prodotti Silca.

E IMPORTANTE

En conformidad con las vigentes disposiciones de ley sobre propiedad industrial, las marcas y denominaciones comerciales citadas en nuestro catálogo se declaran de propiedad exclusiva de los fabricantes de cerraduras y los utilizadores autorizados.

Dichas marcas o denominaciones comerciales se citan por simple información, al objeto de hacer comprender sin dificultad a qué cerraduras van destinadas nuestras llaves.

Este catálogo está reservado exclusivamente a los profesionales de la reproducción de llaves que utilizan los productos Silca.

D WICHTIG

Gemäß den derzeit geltenden Normen bezüglich des Industrieigentums teilen wir Ihnen mit, daß die im vorliegenden Katalog angeführten Markennamen oder Handelsmarken ausschließliches Eigentum der Schloßhersteller und zugelassenen Fachhändler sind.

Diese Markenbezeichnungen oder Handelsmarken sind nur zur Information angeführt, mit dem Zweck, schnell erkennen zu können, zu welchem Schloß unsere Schlüssel gehören.

Der vorliegende Katalog ist ausschließlich an Schlüsselkopier-Fachgeschäfte, die Silca Produkte benutzen, gerichtet.

P IMPORTANTE

Em conformidade com as disposições legais em vigor relativas à propriedade industrial, informamos que as marcas ou as denominações comerciais citadas no nosso catálogo são propriedade exclusiva dos fabricantes de fechaduras e dos utilizadores autorizados.

Estas marcas ou denominações comerciais são indicadas só a nível de informação, a fim de reconhecer rapidamente a quais fechaduras se destinam as nossas chaves.

Este catálogo é reservado exclusivamente aos profissionais da reprodução de chaves que utilizam os produtos Silca.

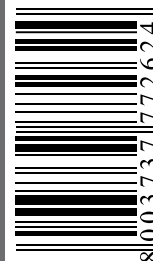

P393
Printed in Italy 06/10



SILCA S.p.A.
Via Podgora, 20 (Z.I.)
31029 VITTORIO VENETO (TV)
Tel. +39 0438 9136
Fax +39 0438 913800
E-mail: silca@silca.it
www.silca.biz

SILCA GmbH
Siemensstrasse, 33
42551 VELBERT
Tel. +49 2051 2710
Fax +49 2051 271172
E-mail: info@silca.de
www.silca.de

SILCA KEY SYSTEMS S.A.
C/Santander 73A
08020 BARCELONA
Tel. +34 93 4981400
Fax +34 93 2788004
E-mail: silca@silca.es
www.silca.es

SILCA Ltd.
Unit 2 Kimpton Trade & B. C.
Kimpton Road - Sutton
SURREY SM3 9QP
Tel. +44 208 6416515
Fax +44 208 6441181
E-mail: sales@silcald.co.uk
www.silcald.co.uk

SILCA S.A.S.
12 Rue de Rouen - B.P. 37
Z.I. Limay - Porcheville
78440 PORCHEVILLE
Tel. +33 1 30983500
Fax +33 1 30983501
E-mail: info@silca.fr
www.silca.fr

MINDA SILCA Engineering Ltd.
Plot no. 37- Toy City
Greater Noida-201308, U.P.
Tel : +91 9871397630/31
Fax: +91 120 2351301
E-mail: info@mindsilca.in
www.mindsilca.in

H. CILLEKENS & ZN. B.V.
Metaalweg, 4
6045 JB ROERMOND
Tel. +31 475 325147
Fax +31 475 323640
E-mail: info@hcillekens.nl
www.hcillekens.nl

Members of the Kaba Group

